

Environmental
Studies
Revolving
Funds

027 Sediment Transport —
Present Knowledge and
Industry Needs

The Environmental Studies Revolving Funds are financed from special levies on the oil and gas industry and administered by the Canada Oil and Gas Lands Administration for the Minister of Energy, Mines and Resources, and by the Northern Affairs Program for the Minister of Indian Affairs and Northern Development.

The Environmental Studies Revolving Funds and any person acting on their behalf assume no liability arising from the use of the information contained in this document. The opinions expressed are those of the authors and not necessarily reflect those of the Environmental Studies Revolving Funds agencies. The use of trade names or identification of specific products does not constitute an endorsement or recommendation for use.

ENVIRONMENTAL STUDIES REVOLVING FUNDS

REPORT NO. 027

APRIL 1986

BOTTOM SEDIMENT TRANSPORT -
PRESENT KNOWLEDGE AND INDUSTRY NEEDS

Donald O. Hodgins
David A. Huntley
W.D. Liam Finn
Bernard Long
Georges Drapeau
Anthony J. Bowen

Seaconsult Marine Research Ltd.
405-1200 West 73rd Avenue
Vancouver, British Columbia

Scientific Advisor: Michael E. Coolen

The correct citation for this report is:

Hodgins, D.O., D.A. Huntley, W.D. Liam Finn, B. Long,
G. Drapeau and A.J. Bowen. 1986. Bottom sediment
transport -- present knowledge and industry needs.
Environmental Studies Revolving Funds Report 027.
Ottawa. 394 p.

Published under the auspices
of the Environmental Studies
Revolving Funds
ISBN 0-920783-26-0
© Seaconsult Marine Research Ltd.

SUMMARY

Sediment transport and soil liquefaction under wave loading are major concerns for offshore hydrocarbon developments in Canadian waters. This report presents a state-of-the-art review of five topics concerned with seabed mobility and liquefaction, together with a summary of research priorities to address a number of outstanding problems facing the offshore industry. The review deals with sediment transport produced by waves and currents without structures such as pipelines or platform footings present to modify the flow. Thus such topics as localized scour around structures are not considered.

The physics governing sediment transport on continental shelves and soil liquefaction, together with mathematical theories for predicting transport rates and changes in pore water pressure and effective stress, are discussed by Huntley and Finn respectively. It is concluded that while progress has been made in predicting transport rates, much uncertainty remains due to fairly crude parameterizations of the bottom boundary layer and seabed stress. Major problems to be solved include turbulent stress models, the resolution of form drag and skin stresses in the presence of ripples, the effects of biological activity and boundary layer models for a spectrum of waves. With respect to pore pressure prediction under waves it has been found that available models are based on the same fundamental assumptions, i.e. Biot's (1941) equations for a poroelastic solid, and that results for transient and residual porewater pressures appear reasonable against very limited test data. Finn notes, however,

that transient analyses for effective stress due to wave loading are not yet established for the poroelastic model. More test data are needed, both from the laboratory and field. A similar problem exists for residual pore pressures and stresses: they are not well tested against in situ data and this remains the major problem for verifying the methods.

The next two sections by Long, and Huntley and Drapeau, review sediment transport monitoring techniques. Long examines tracer methods, and concludes that the advantages of radio-isotope techniques: cost effectiveness, quality of tracer, ease of detection, and quality of detection make this the preferred approach for long-term measurements of total load transport. This method is well suited to experiments on continental shelves provided that detection surveys can be navigated accurately. Huntley and Drapeau have examined non-tracer methods for monitoring transport. A major problem is the lack of a reliable method for measuring bedload transport. Acoustic profiling instruments for suspended sediment and current are developing and appear promising, but must be complemented by bedload estimates. Huntley and Drapeau point to the immediate need for improved techniques, probably acoustic, for bedform migration measurements.

Numerical modelling of sediment transport, discussed by Bowen, addresses the question of time and space scales in sediment prediction, and provides an assessment of modelling transport at a point and in two dimensions. He concludes that while very complex models may be formulated, without data for calibration the results will contain a great deal of uncertainty.

The central problem in applying any of the existing models in Canadian waters is the lack of reliable hydrodynamic input data and in situ sediment transport measurements. The primary requirement is for a field experiment to measure boundary layer hydrodynamics, sedimentary environment and sediment motion. These data would yield a calibrated prediction model for sediment transport.

In the final section, Hodgins has examined research priorities for Canadian offshore development. Ten studies are recommended, seven to address areas of immediate concern and three of a more fundamental nature.

The recommended studies are:

- measurement and modelling of sand transport on Sable Island Bank,
- a sand ridge migration study on Sable Island Bank,
- a definition study to examine soil liquefaction and transport phenomenon in the Beaufort Sea,
- a beach stability study for pipeline shore-crossing zones in the Beaufort Sea,
- three-dimensional mathematical modelling of artificial island erosion in the Beaufort Sea,
- measurement and prediction of ice scour sedimentation on the Grand Banks,
- surveys of ice scour characteristics in the Beaufort Sea shore zones (pipeline crossings),
- development of acoustic sediment and velocity profiling instrumentation for suspended and bedload motion,
- stress parameterization in the bottom boundary layer based on detailed flow measurements (stress intermittency and resolution of the form drag/skin friction problem), and

- development of a sediment transport hindcast model for Sable Island Bank based on calibrated current, wave and sand transport models using a descent of scales, and realistic sediment grain size distributions.

RESUME

Le débit solide et la liquéfaction du sol sous la charge des vagues sont des préoccupations d'importance pour le développement marin des hydrocarbures dans les eaux canadiennes. Ce rapport présente une étude récente de cinq sujets sur la mobilité et la liquéfaction du fond marin, ainsi qu'un résumé des priorités de recherche destinées à répondre aux problèmes importants auxquels doit faire face l'industrie marine. Cette analyse traite du débit solide produit par les vagues et les courants, en l'absence de structures telles que pipelines ou fondations de plates-formes, qui modifieraient le débit de ces éléments marins. On n'a donc pas envisagé de parler de questions telles que l'affouillement localisé autour des structures.

Huntley et Finn discutent respectivement des lois physiques qui régissent le débit solide, sur les plateaux continentaux, et la liquéfaction du sol, ainsi que des théories mathématiques permettant de prévoir les taux de débit et les changements de la pression de l'eau interstitielle et de la tension effective. Ils concluent en indiquant que, malgré les progrès réalisés dans les prévisions des taux de débit, il reste encore beaucoup de doutes, en raison de la détermination assez rudimentaire des paramètres de la couche limite et de la tension du fond. Les principaux problèmes à résoudre concernent les modèles de tensions de la surface, en présence d'ondulations, les effets de l'activité

biologique et des modèles de couche limite pour un spectre de vagues. Pour ce qui a trait à la pression interstitielle sous l'effet des vagues, on a découvert que les modèles disponibles reposent sur les mêmes hypothèses fondamentales, c'est-à-dire sur les équations de Biot (1941) concernant un solide poroélastique. On a également trouvé que les résultats des pressions transitoires et résiduelles de l'eau interstitielle semblent raisonnables, comparés aux données très limitées qu'ont pu fournir les essais. Finn remarque, cependant, que les analyses transitoires sur la tension effective, causée par la charge des vagues, ne sont pas encore déterminées pour le modèle poroélastique. Il faut obtenir davantage d'informations sur les tests, à la fois auprès du laboratoire et du milieu naturel. Les pressions résiduelles interstitielles et les tensions rencontrent le même problème: elles ne sont pas convenablement testées, par rapport aux données fournies sur le site, ce qui reste l'inconvénient majeur dans la vérification des méthodes employées.

Les deux parties suivantes traitées par Long, Huntley et Drapeau, analysent les techniques de surveillance du débit solide. Long étudie les méthodes par traceur et conclut ainsi: les avantages des techniques radio-isotopes, soit la rentabilité des coûts, la qualité du traceur, la facilité de détection et sa qualité rendent cette méthode préférable, quand il s'agit d'établir des mesures du débit total de la charge, à long terme. Ce procédé convient parfaitement aux expériences menées sur les

plateaux continentaux, à la condition que les études de détection soient dirigées avec précision. Huntley et Drapeau ont étudié les méthodes n'utilisant pas de traceur de surveillance du débit. L'un des problèmes importants est le manque d'une méthode fiable pour mesurer le débit de la charge de fond. Des instruments acoustiques, servant à évaluer les sédiments en suspension et à mesurer les courants, se développent et paraissent prometteurs; ils doivent, cependant, s'accompagner de prévisions de la charge de fond. Huntley et Drapeau font remarquer le besoin immédiat d'améliorer les techniques acoustiques servant à mesurer le déplacement de la configuration du lit.

La modélisation numérique du débit solide, telle que la décrit Bowen, répond à la question des échelles de temps et d'espace dans les prévisions de dépôt et donne une évaluation du débit des modèles, à un moment donné et en deux dimensions. Il conclut en précisant que, malgré la formulation éventuelle de modèles très complexes, sans aucune donnée de calibrage, les résultats risquent d'être incertains. Le manque de données hydrodynamiques fiables et de mesures du débit solide sur place représente le problème majeur, si l'on introduit l'un des modèles existants, aux eaux canadiennes. La principale exigence, dans une expérience en milieu naturel,

est de mesurer l'hydrodynamique de la couche limite, le milieu sédimentaire et le mouvement des sédiments. Ces données fourniraient, sur le débit solide, un modèle de prédiction bien calibré.

Dans la partie finale, Hodgins a étudié les priorités de recherche pour le développement marin au Canada. Il recommande dix études, soit sept traitant des domaines de préoccupation immédiate et trois plus essentielles.

Ces études sont les suivantes:

- la mesure et la modélisation du transport de sable sur le banc de l'île de Sable;
- une analyse du déplacement des bancs de sable sur le banc de l'île de Sable;
- une analyse définitionnelle, afin d'examiner le phénomène de liquéfaction du sol et du débit dans la mer de Beaufort;
- une analyse de la stabilité du rivage pour les zones de croisement des pipelines sur le littoral de la mer de Beaufort;
- la modélisation mathématique à trois dimensions de l'érosion des îles artificielles dans la mer de Beaufort;

- la mesure et les prévisions de sédimentation due à l'affouillement sur les Grand Bancs;
- des études sur les caractéristiques de l'affouillement sur le littoral de la mer de Beaufort (intersections de pipelines);
- la mise au point d'instruments acoustiques permettant de déterminer le profil de sédimentation et de vitesse pour le mouvement des sédiments en suspension et le déplacement de la charge de fond;
- la détermination des paramètres de pression sur la couche limite du fond, fondés sur des mesures détaillées du débit (intermittence de la pression et résolution du problème des forces de traînée et de la friction de la surface); et
- la mise au point d'un modèle d'étude rétrospective du transport des sédiments sur le banc de l'île de Sable, reposant sur un courant calibré, des modèles de débit des vagues et de transport de sable, selon des échelles grossières, ainsi que sur des répartitions réalistes de la granulométrie des sédiments.

TABLE OF CONTENTS

	PAGE
SUMMARY	i
CHAPTER	
1. INTRODUCTION.....	1
2. PHYSICAL CONCEPTS OF SEDIMENT TRANSPORT ON CONTINENTAL SHELVES.....	3
2.1 INTRODUCTION.....	3
2.2 THRESHOLDS FOR SEDIMENT MOTION.....	5
2.3 EQUATIONS FOR SEDIMENT TRANSPORT.....	15
a) Bedload Transport	15
b) Suspended Load Transport	23
c) Comparisons Between Sediment Transport Calculations	27
2.4 BOTTOM BOUNDARY LAYERS.....	30
a) The Form Drag Problem	30
b) Combined Wave and Current Effects	37
c) Other Complications	41
2.5 SUMMARY AND DISCUSSION OF FUTURE RESEARCH NEEDS.....	46
2.6 REFERENCES.....	52
3. WAVE INDUCED PORE WATER PRESSURES AND SEAFLOOR STABILITY.....	59
3.1 INTRODUCTION.....	59
3.2 TRANSIENT PORE WATER PRESSURES AND STRESS STATES.....	64
a) Coupled Effective Stress Analyses	64
b) Uncoupled Analysis of Soil-Water Systems	69
c) Comparative Analyses	73
3.3 WAVE TANK DATA.....	86
a) Small Scale Tests	86
b) Large Scale Tests	104

c)	Conclusions from Wave Tank Studies	107
3.4	FIELD DATA ON TRANSIENT PRESSURES.....	110
3.5	RESIDUAL PORE WATER PRESSURES AND LIQUEFACTION POTENTIAL.....	124
a)	Seed-Rahman Method	124
b)	Analysis by Computer Programs Stab-W and Stab-W3.	125
3.6	FIELD AND LABORATORY DATA ON RESIDUAL PORE WATER PRESSURE.....	127
a)	Cornell Laboratory Tests on Silt	129
b)	Field Data on Residual Pore Water Pressures	133
3.7	ASSESSMENT OF SEAFLOOR STABILITY.....	134
3.8	EVALUATION OF CURRENT METHODS OF ANALYSIS..	142
3.9	FUTURE RESEARCH NEEDS.....	143
3.10	REFERENCES.....	146
4.	TECHNIQUES DE TRACAGE.....	151
4.1	INTRODUCTION.....	151
4.2	REVUE DES DIFFERENTES METHODES DE TRACAGE... 152	
a)	Les Traceurs Naturels	153
b)	Traceurs Artificiels	157
4.3	LES TRACEURS LUMINESCENTS.....	183
4.4	LES TRACEURS RADIOACTIFS.....	190
4.5	LES AUTRES TECHNIQUES DE MARQUAGES.....	198
a)	Les Traceurs Magnetiques	198
b)	L'analyse par Thermoluminescence	198
c)	L'analyse par Neutro-Activation	199
4.6	CONCLUSION GENERALE.....	200
4.7	RÉFÉRENCES.....	204
5.	DIRECT AND INDIRECT METHODS FOR MEASURING SEDIMENT TRANSPORT.....	215
5.1	INTRODUCTION.....	215

5.2	SENSORS FOR DIRECT MEASUREMENT.....	217
	a) Suspended Sediment Sensors	219
	b) Bedload Sensors	228
	c) Instrument Systems for Sediment Transport Studies on Continental Shelves	230
5.3	INDIRECT ESTIMATION METHODS.....	234
	a) Bedform Migration	
	b) Point Measurements of Erosion and Deposition	236
	c) Repeated Bathymetric Surveys	238
5.4	CONCLUSIONS.....	239
5.5	REFERENCES.....	241
6.	NUMERICAL MODELLING OF SEDIMENT TRANSPORT.....	245
6.1	INTRODUCTION.....	245
6.2	MODELLING: MOTIVATION, SPACE AND TIME SCALES.....	247
	a) Problems of Sediment Transport	247
	b) Spatial Scales	249
	c) Time Scales	251
6.3	MODELLING SEDIMENT TRANSPORT AT A POINT.....	254
	a) Input Parameters	254
	b) Hydrodynamics	255
	c) Sedimentary Environment	261
	d) Sediment Transport Relations	267
6.4	TWO-DIMENSIONAL MODELS.....	274
	a) Diagnostic Models	274
	b) Predictive Models	275
6.5	MODELS FOR SABLE ISLAND BANK.....	278
	a) Existing Models	278
	b) A Two-Dimensional Model	280
6.6	SUMMARY AND DISCUSSION OF FUTURE RESEARCH NEEDS.....	285
6.7	REFERENCES.....	290

7.	RESEARCH PRIORITIES IN CANADIAN WATERS.....	295
7.1	INTRODUCTION.....	295
7.2	KEY ISSUES IN SEDIMENT TRANSPORTATION.....	296
	a) Offshore Pipelines	296
	b) Artificial Island Stability	300
	c) Scour Dating	300
	d) Glory Hole Infilling	301
7.3	A PERSPECTIVE ON THE PRESENT SITUATION.....	301
7.4	RESEARCH PRIORITIES.....	305
	a) Immediate Research Needs	305
	i) Offshore Pipelines - Scotian Shelf	305
	A - Measurement and Prediction of Sand Transport Rates on Sable Island Bank	305
	B - Sand Ridge Migration Study on Sable Island Bank	309
	ii) Offshore Pipelines - Beaufort Sea	312
	A - Sediment Behaviour in Storms - Problem Definition Study	314
	B - Baseline Data for Beach Stability Analysis - North Head and Toker Point	316
	iii) Artificial Island Stability	318
	A - Model Study of Island Erosion in the Beaufort Sea	319
	iv) Scour Infilling	320
	A - Scour Infilling Predictions for the Grand Banks	321
	B - Ice Scour Properties in the Beaufort Sea	323
	v) Glory Hole Infilling	324
	b) Fundamental Studies	324
	A - Acoustic Suspended and Bedload Transport Instrumentation	325
	B - Stress Parameterization in the Boundary Layer	326

	C - Continued Development of Predictive Models for Sediment Transport	328
7.5	REFERENCES.....	331
APPENDIX 1	TRACER TECHNIQUES by Bernard Long.....	333

CHAPTER 1

INTRODUCTION

by

DONALD O. HODGINS

President

Seaconsult Marine Research Ltd.

Five topics concerned with seabed mobility and the implications for offshore hydrocarbon production on the Scotian Shelf and in the Beaufort Sea are discussed in this report. The objective is to review the current state of knowledge about physical processes producing large scale sediment motion, including pore-water pressure changes under cyclic loading, the measurement of sediment transport, and numerical modelling of transport phenomena with a view to identifying major areas needing research. The perspective is one of solving problems of immediate and pressing concern to offshore companies engaged in the design of platforms, subsea production systems and pipelines. While the focus is on the Scotian Shelf, and Sable Island Bank in particular, the discussion is general enough to apply to other continental shelf areas as well.

The issues dealt with in this report pertain to sediment transport produced by waves and currents without structures, such as platforms, flowlines or pipelines, present to modify the flow. Suspended and bedload transport, the formation and migration of bedforms, and slumping and slope stability induced by changes in

effective soil stresses are considered. Localized scour, produced by the interaction of wave and current flows with structures, are not treated. This topic is covered in a companion report commissioned by the Environmental Studies Revolving Funds.

First we consider physical processes governing sediment transport and changes in porewater pressure under wave loading (Chapters 2 and 3). This is followed by an evaluation of techniques for monitoring transport rates, divided into Chapters 4 and 5, dealing respectively with tracer techniques and other direct and indirect estimation procedures. In Chapter 6 we discuss approaches to numerically modelling transport processes emphasizing the relationship of model formulation to our present understanding of the governing physics and what one expects to achieve with a given model. In each chapter the discussion centers on the limitations of present knowledge and techniques, to point out clearly those aspects which require research to advance our ability to predict seabed changes under oceanic conditions.

Finally a review of industry requirements is presented in Chapter 7 followed by a synopsis of the research topics presented in earlier chapters. This leads to a list of research requirements pertinent to Canadian offshore development.

CHAPTER 2
PHYSICAL CONCEPTS OF SEDIMENT TRANSPORT
ON CONTINENTAL SHELVES

by

D.A. HUNTLEY

Department of Oceanography
Dalhousie University

2.1 INTRODUCTION

Sediment transport prediction on continental shelves generally involves equations which attempt to relate net and gross sediment transport to readily measured or estimated synoptic parameters such as wave height and period, wind speed and direction, tidal currents and mean currents. However the link between the moving sediment near the seabed and these synoptic parameters is highly complex. To formulate satisfactory equations we must understand both the hydrodynamics of the boundary layer at the seabed, and the sediment dynamics in response to the boundary layer flows. In many cases the hydrodynamics and sediment dynamics can be considered separately, but when moving sediment concentrations become appreciable, the flows in the boundary layer will be modified and the hydrodynamics and sediment dynamics must be considered together. The purpose of this chapter is to review our current

understanding of the relationship between synoptic parameters and sediment transport.

Much of the early work on sediment transport concerned itself with river flows and aeolian sand transport; only relatively recently has sediment transport on continental shelves has been studied, initially for geological reasons (Swift et al., 1972) and even more recently in response to the increasing concerns about waste dumping and hydrocarbon exploration. As a result the equations and empirical approaches to sediment transport were not originally formulated for continental shelf environments. Nevertheless, over the past decade or so, sediment transport formulae for continental shelves have become increasingly refined as a result of research that has both clarified the physical processes and provided some, though still scarce, data against which to test predictions. However, further research is needed before we can confidently predict transport rates, even at an order of magnitude level, for the wide range of conditions occurring on continental shelves.

The following Section of this chapter looks at the problem of estimating thresholds for the initiation of sediment transport. This is followed by a Section outlining the equations used for sediment transport prediction, and a discussion of some recent assessments of their accuracy in field environments. Section 2.4 then looks more closely at the boundary layer flows and the correct formulation of the stresses that are used in the sediment transport equations. Complications due to bedforms and oscillatory flows combined with mean flows are considered. In

addition, Section 2.4 addresses problems of 'feedback' interaction between moving sediment and/or bedforms, and the flow regime. The final Section then summarizes the state of the art and discusses future research directions.

2.2 THRESHOLDS FOR SEDIMENT MOTION

The threshold at which sediment particles are just disturbed and set into motion is defined by a critical value of the stress, τ_c which the water exerts on the bed. Competancy curves, relating this stress (or some parameter related to stress) to sediment grain diameter have been produced by a number of authors. The competency curves most frequently used are those given by Shields (1936). At the critical stress the frictional and gravitational forces on the sediment are just balanced by the fluid forces. Shields therefore argued that the appropriate non-dimensional form for the critical stress is the ratio

$$\theta_t = \frac{\tau_c}{(\rho_s - \rho)gd} \quad (2.1)$$

where d is the mean grain diameter, ρ_s and ρ are sediment and water densities respectively, and θ is known as the Shields parameter. The critical Shields parameter is found to vary with the boundary Reynolds number

$$R = \frac{u_* d}{\nu} \quad (2.2)$$

where $u_* = (\tau/\rho)^{1/2}$, known as the friction velocity, and ν is the kinematic viscosity. R , a Reynold's number, expresses the ratio between the viscous sublayer thickness and the boundary roughness. The usual Shields diagram therefore has θ_t plotted

against R , although it is often plotted against the square of a non-dimensional sediment fall velocity, as in Fig. 2.1 (from Smith, 1977). This latter form, known as a modified Shields diagram, is somewhat easier to use since the stress appears only in the ordinate parameters. For quartz grains in water the Shields curve given in Fig. 2.2 is appropriate; here the Shields parameter has been replaced by the friction velocity.

As can be seen in Fig. 2.1, there is considerable uncertainty about the shape of the Shields curve for small particle diameters. This uncertainty is discussed further by Miller et al. (1977) and Nowell et al. (1981). The latter conclude that a critical stress for particle diameters below about 100 μm cannot be predicted with any accuracy. A major part of this uncertainty is due to variable cohesion between particles with small grain sizes.

Application of the Shields curve is strictly only valid for steady flow over a flat bed and for uniform sediment size.

Modification of the Shields curve over seabed topography is complicated by the presence of a form drag contribution to the total stress caused by a non-zero average pressure over bedforms (see Section 2.4). This form drag does not cause sediment motion but makes the critical total stress higher over bedforms. Inman (1963) shows a modified Shields curve with a branch towards higher threshold stresses for rippled beds. However, as Middleton and Southard (1977, page 6.17) pointed out, the critical bed stress over a rippled bed is actually less than over a flat bed once form drag has been removed because flow separation over the ripple crests produces high stresses locally that can put

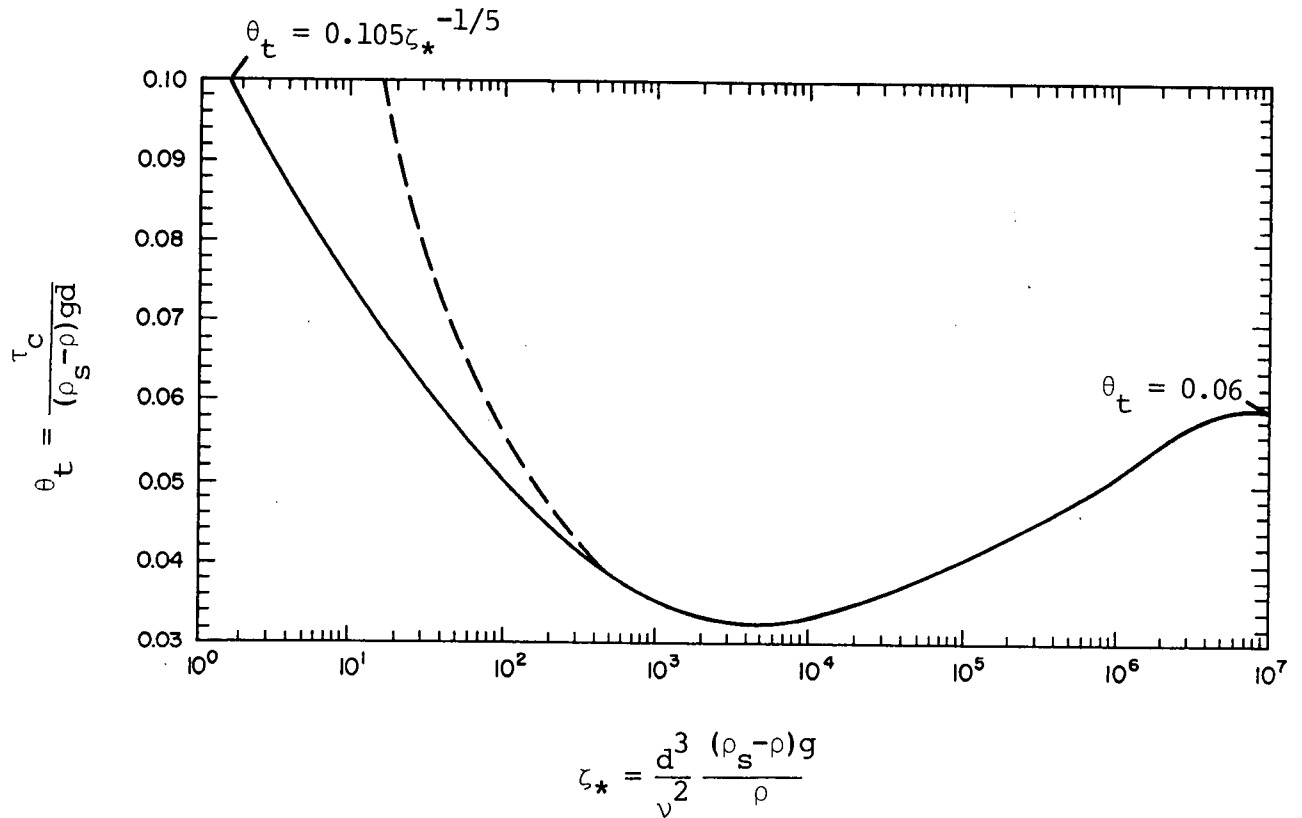

Fig. 2.1 Nondimensional boundary shear stress required to initiate sediment transport as a function of the nondimensional number representing fluid and sediment properties. The dashed curve and the solid one to the right side of the branch are from the Shield's diagram as modified by Vanoni (1964), and usually plotted in terms of $(u_*')_t d/\nu = (\zeta_* \theta_t)^{1/2}$. The solid line to the left of the branch is based on data of White (1970) for noncohesive material of silt size. For large ζ_* , $\theta_t = 0.06$, and for small ζ_* , White's expression yields an asymptotic value of $\theta_t = 0.105 \zeta_*^{-1/5}$. Strictly speaking, Shield's diagram and curves derived from it such as the one presented here apply only to geometrically smooth beds of well-sorted sedimentary material for which $d = k_s$. (after Smith, 1977).

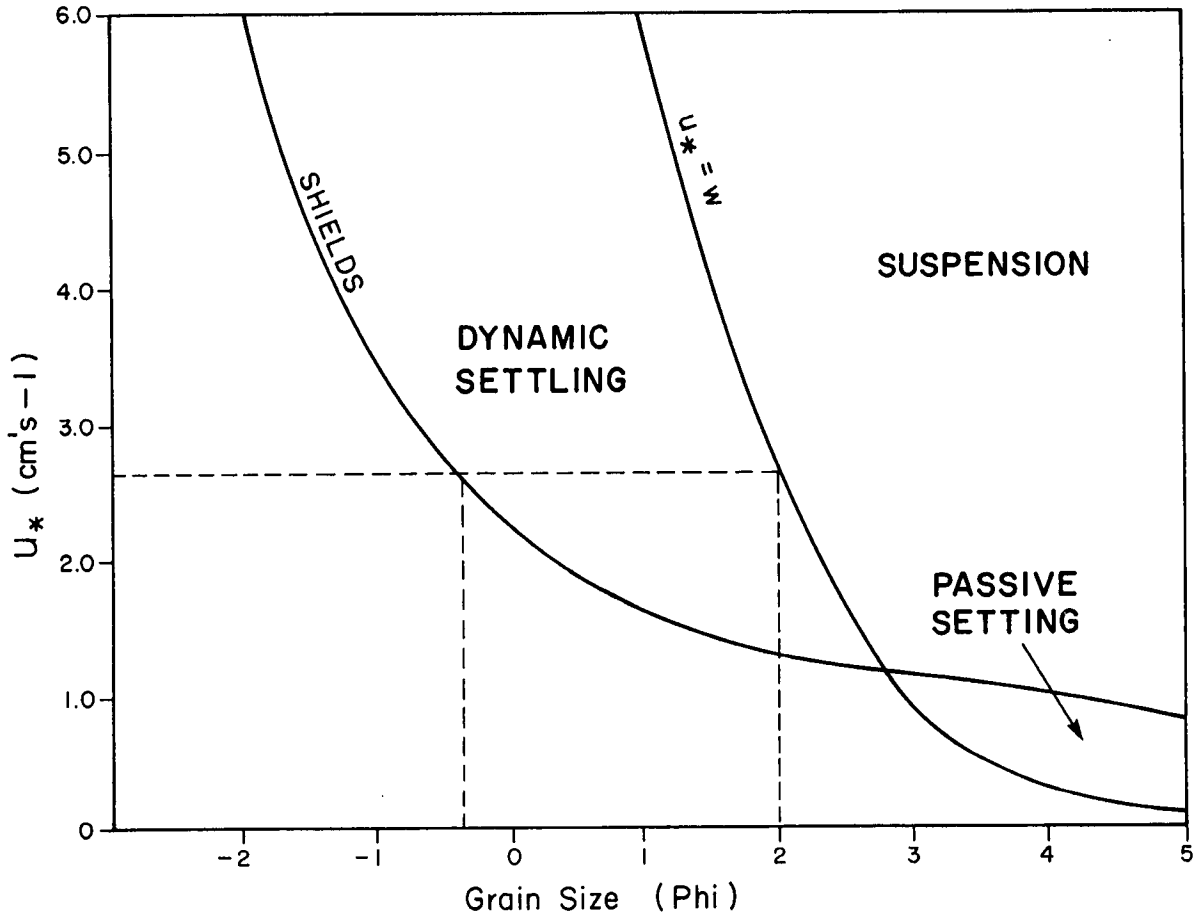

Fig. 2.2 The Shield's curve for quartz grains in water. Also shown is the curve of $u_* = w$. Above the cross-over at Phi just below 3 grains will go straight into suspension once the stress reaches their threshold.

sediment into motion. Nevertheless, measurements by Sternberg (1971) in tidal channels in Puget Sound suggest that Inman's modified Shields curve predicts sediment threshold over rippled beds quite well if the total stress (including form drag) is used. His data also show surprisingly good agreement for thresholds for the sand fraction even when the sand is incorporated in a poorly sorted sediment mix including much larger sized particles, indicating that the Shields curve is not critically dependent on the requirement of uniform sediment.

The important influence of biological activity on sediment-water interaction has been the subject of a number of recent papers (e.g. Rhoads, 1974; Nowell et al., 1981; Grant et al., 1982). Two opposing influences may occur: binding of surface sediments for example by mucous coatings, and destabilizing of the sediment by, for example, burrowing, tracking and interception of boundary layer flow by animal tubes. Biological effects are very variable, and depend, among other factors, on sediment composition and organism density and type. Modifications to Shields diagrams to account for biological activity tend therefore to be site specific and it is as yet difficult to derive general results. For fine to medium sands from an intertidal region, Grant et al. (1982) found, in laboratory flume experiments, that although biological cohesion tended to increase the critical stress relative to the Shields diagram, the increase was never more than a factor of two. Since this change is well within the generally accepted level of uncertainty in the Shields curve due to numerous other factors,

it is not of major significance. As expected, biological reworking tends to lower the critical value back to the average Shields curve. Flume studies by Nowell et al. (1981) showed that, for fine sand, animal tracks cause significant increases in bed roughness and hence decrease critical stresses. In their experiments the critical stress decreased by about 40%.

The overall importance of biological activity for sediment transport on the continental shelf is hard to assess at present, not only because of the wide variety of possible effects and their variability both in space and time, but also because of a paucity of quantitative information about the levels of benthic biological activity and its patchiness over most shelves. Nevertheless the experimental work carried out to date suggests that this merits further investigation.

For oscillating flows, Komar and Miller (1973, 1975) suggested threshold equations of the form

$$\begin{aligned} \theta_{t,w} = \frac{\rho u_m^2}{(\rho_s - \rho)gd} &= k \left(\frac{D_o}{d} \right)^{1/2} & d < 0.5 \text{ mm.} & (2.3) \\ &= 1.45 \left(\frac{D_o}{d} \right)^{1/4} & 0.5 < d < 50 \text{ mm.} & \end{aligned}$$

where D_o is the orbital diameter of the wave motion, u_m is the maximum oscillatory velocity and k is an empirically determined constant with a value between 0.11 and 0.21. Madsen and Grant (1975) however, showed laboratory results which suggested that the Shields curve remained a suitable form for the threshold under waves, provided that the stress was calculated appropriately. They used the form

$$\tau_w = 1/2 \rho f_w u_m^2 \quad (2.4)$$

where f_w is the wave friction factor defined by Jonsson (1966). In either case there is a slight dependence of the critical stress, or velocity, on wave period, as can be seen in Fig. 2.3.

Most threshold estimates are based on laboratory measurements, and there have been few field measurements to test the predictions. For most continental shelf locations wave-induced flows and much longer period flows are both present for much of the time. As we shall see in Section 2.4, this makes calculation of the stress at the seabed substantially more complex than for waves or currents alone. Larsen et al. (1981) describe field measurements of the threshold of sediment suspension on three continental shelf sites, two on the Washington shelf in about 90 m water depth, and one on the Australian shelf in 75 m water depth. This study considered resuspension on a storm event time-scale rather than on a time scale of individual waves. The threshold was estimated using a nephelometer or transmissometer 30 cm above the bed, with some confirmatory evidence from bottom photographs. Stresses were estimated using a Savonius rotor and direction vane 100 cm above the bed to measure mean flows and mean and wave current directions, and a quartz crystal pressure transducer to measure wave conditions. The data were used to evaluate three different methods of estimating sediment thresholds. Two use the Shields curve, plotted against the boundary Reynolds number. In one case stress was computed using (2.4), while in the second case, stress was calculated by a slight modification of the Grant and Madsen (1979) theory for wave/current boundary layers (see Section 2.4).

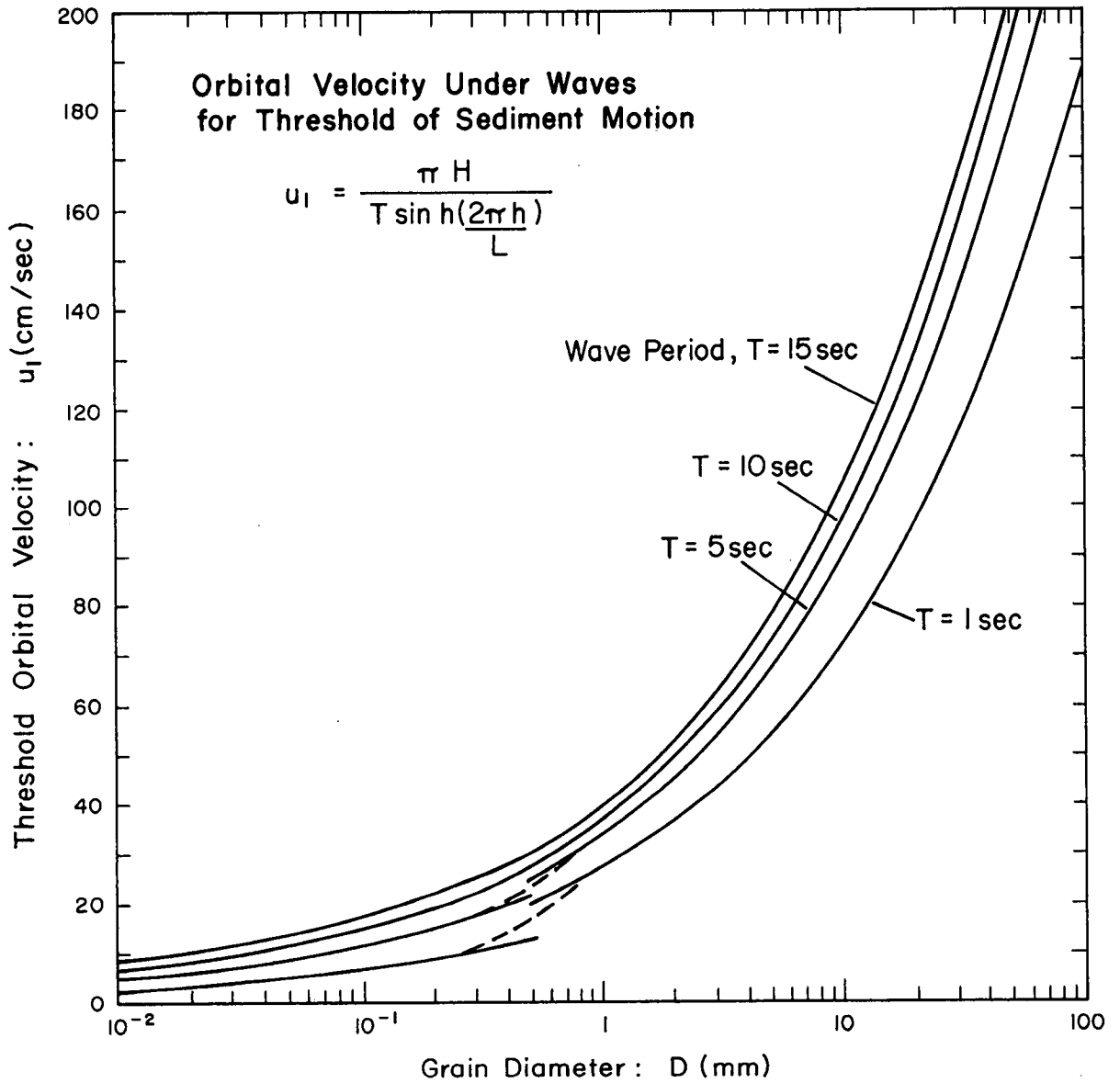

Fig. 2.3 Threshold orbital velocity required to initiate motion of grains of quartz, as a function of grain diameter and wave period. The near-bottom velocity u and wave height H can be related using the formula shown, where T and L are the wave period and wavelength respectively. (after Komar, 1976)

The third method used Komar and Miller's (1973, 1975) theory, (2.3). Unfortunately the range of conditions experienced during the field measurements was not broad enough to distinguish between these approaches, and the authors could only conclude that all three gave results that were within the scatter of results of the laboratory studies on which they were based. With so few data it is difficult to draw firm conclusions but their results, shown on a Shields curve in Fig. 2.4, suggest that their threshold stresses could be estimated to within a factor of two or three using a Shields criterion. Surprisingly the wave/current stresses appear to be higher above the Shields curve than the simpler wave stresses, perhaps because the threshold is being measured by a sensor well above the bottom.

Discussion of the special and complex behaviour of sediments in the combined presence of bedforms, waves and currents is reserved for Section 2.4.

Finally, it should be recognised that even the concept of a threshold stress or current is not precise. At the smallest scales, local fluctuations of turbulent stress can initiate sediment motion when the average stress is well below the threshold. In addition, under wave conditions, the spectral nature of wave motion will make instantaneous velocities and stresses impossible to predict. Laboratory observations by Grass (1970) demonstrate very clearly the stochastic nature of the threshold. In steady flow, he found that fluctuations in shear stress in the viscous sublayer, resulting from turbulence in the flow above, had a standard deviation of 40% of the mean, but that, in addition, there was a 30% variation in the stress at

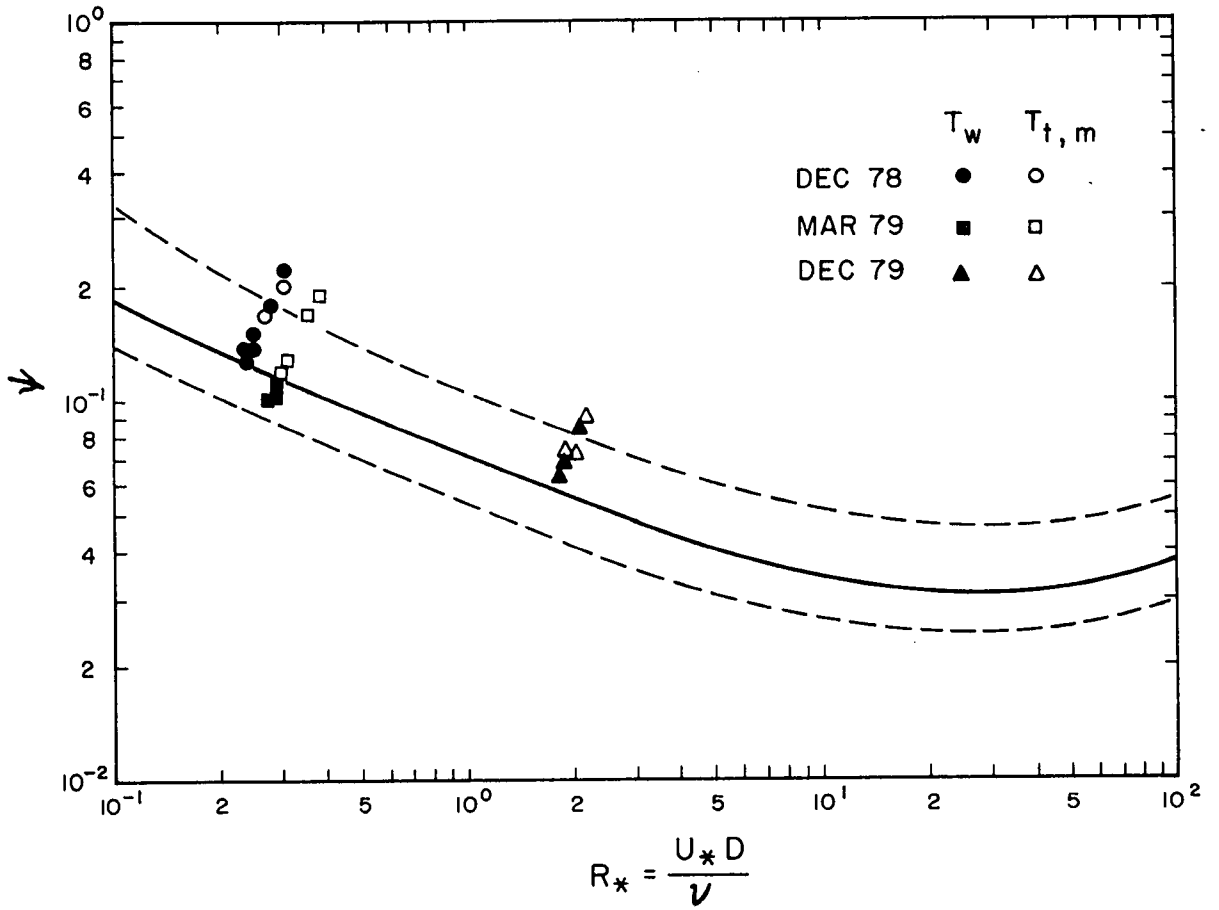

Fig. 2.4 Data from eleven threshold events plotted on the Shields' curves (after Larsen et al., 1981).

which individual particles moved, presumably because of variations in local packing and the exposure of grains. Davies and Wilkinson (1979) found a similar spread of threshold conditions in observations of sediment thresholds under waves in the field.

As will be discussed below, sediment goes into suspension approximately when $u_* = w$, the settling velocity. By comparing this criterion with the Shields threshold criterion, Blatt et al. (1980) show that particles below a certain size go straight into suspension once set into motion while heavier particles move by bedload motion at low stresses and only go into suspension, if at all, at much higher stresses. Fig. 2.2 shows the appropriate curves for quartz grains in water at 20°C and suggests that grains smaller than about 0.10 mm will go straight into suspension. Middleton (1976) uses this kind of plot to explain the trimodal size distribution frequently observed for sand. He argues that, for a given stress, there are modes associated with the onset of sediment motion, with the onset of suspended transport, and a main mode corresponding to intermittent suspension in between. Hill and Bowen (1983) used this idea with some success to describe sediment size distributions in the shelf-slope region off Nova Scotia.

2.3 EQUATIONS FOR SEDIMENT TRANSPORT

a) BEDLOAD TRANSPORT

Of the many equations that have been proposed for bedload transport only three have been generally applied to the oceans:

- i) the Bagnold (1966) formulae
- ii) Einstein's (1964) bedload function
- iii) Yalin's (1963) bedload equation.

All three of these techniques are semi-empirical. We will briefly review each of the techniques below. For a more complete review see Graf (1971).

i) The Bagnold Formulae.

Bagnold's approach is based on a consideration of the overall energetics of the bedload transport. As such it is more satisfying from a physical point of view than the other methods, which depend upon very simplified models of forces acting on individual sediment grains. The basic ideas for transport over a flat bottom are shown schematically in Table 2.1. When bedload moves down an inclined plane of slope β the frictional force must be combined with the downslope gravitational force $I \sin \beta$, and the immersed weight perpendicular to the seabed becomes $I \cos \beta$. The bedload equation for the immersed weight transport rate then becomes

$$i_b = \epsilon_b W / (\tan \theta - \tan \beta) = K_b W \quad (2.5)$$

Various expressions have been used for the work done by the fluid, W . Bagnold used the product of the shear stress and the fluid velocity. Assuming a quadratic stress law, this gives

$$W = c_d \rho u^3$$

Inman et al. (1966) on the other hand used stress multiplied by the friction velocity u_* , so that

$$W = \rho u_*^3$$

The difficulty with the Bagnold equation is the choice of efficiency parameter ϵ_b , or K_b . Bagnold (1963) found evidence

Table 2.1 Bagnold's bedload transport model.

Work done moving the bedload

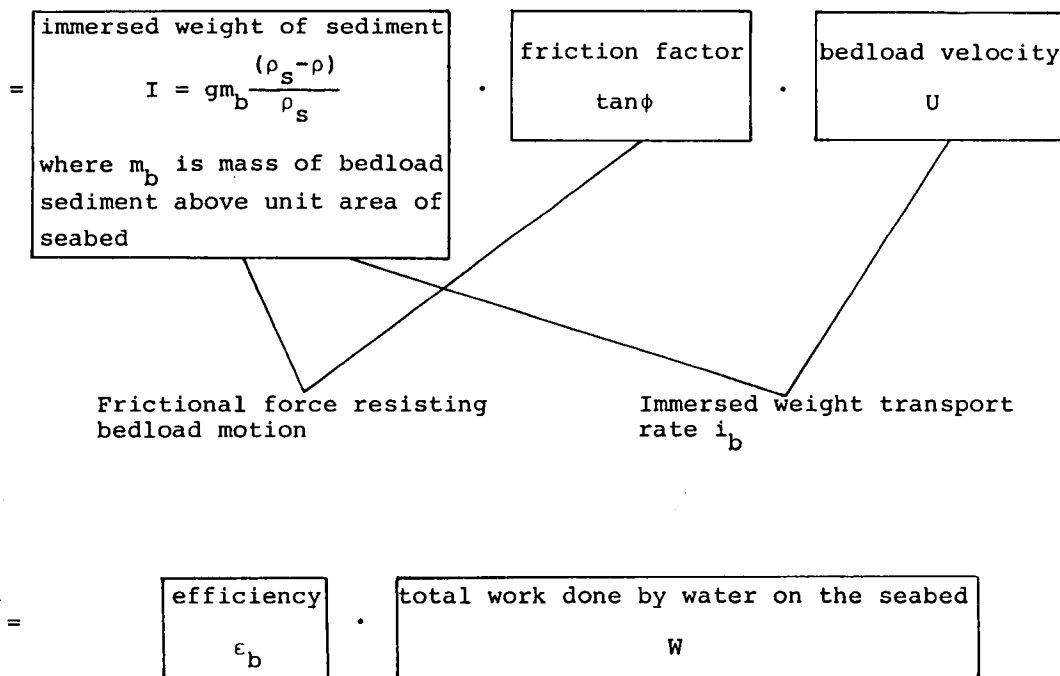

from flume and river data that K_b depends only on the ratio h/d where h is the water depth and d is the mean grain diameter. Kachel and Sternberg (1971), however, found that their field measurements did not agree with the Bagnold model for constant K_b . Sternberg (1972) combined his field data with flume data and deduced empirical curves for K_b a function of the excess shear stress $(\tau - \tau_c)/\tau_c$ and the sediment size. He also provided a nomogram for calculating the bedload transport once a value for K_b and a value for u_* are chosen. Unfortunately the Sternberg method fails to take into account the separation of total stress into a form drag and bed stress. The method, which uses the total stress, is therefore strictly applicable only in circumstances where the ratio of form drag to bed stress is the same as it was for the rippled bed on which Sternberg made his measurements. Nevertheless the problem of choosing the relevant bed stress for rippled beds is common to all methods (at least if separation takes place).

Recent measurements by Langhorne (1981) of sediment transport by volumetric changes in sandwave topography between tidal slack waters suggest that the dependence of K_b on excess stress is considerably weaker than presented by Sternberg (1972).

An alternative, and perhaps more satisfying, way of including the threshold of sediment motion into the Bagnold approach was taken by Gadd et al. (1978). Based on flume data, they suggested an equation of the form

$$q = \gamma (u - u_{th})^3 \quad (2.6)$$

where q is mass discharge of sediment per unit width, u is the

velocity at a standard height above the bed (generally 1 m), u_{th} is the threshold velocity and γ is a constant of proportionality taken to be $4.5 \times 10^{-5} \text{ gm cm}^{-4} \text{ s}^2$ for the fine to medium sand studied.

For oscillatory flows Bagnold (1963) and Inman and Bagnold (1963) argued that the orbital motion of the waves, back and forth with no net transport, acts on the seabed to put sediment into motion, and then it can be readily moved by any net current superimposed on the wave motion. If the mean amplitude of the sediment's oscillatory velocity is u_0 then the mean oscillatory immersed weight transport of sediment is Iu_0 (I is the immersed weight of sediment in motion). From Bagnold's equation for i_b this is equal to $K_b W$. The net transport of sediment, i_m , on the other hand, will be Iu_m , where u_m is the steady flow. Thus

$$i_m = Iu_m = K_b Wu_m / u_0 \quad (2.7)$$

This equation forms the basis for a sediment transport equation for longshore currents in the surf zone. It is important to note, however, that it applies not only to bedload transport but encompasses suspended transport too since an equation analogous to Bagnold's bedload equation can be formulated for suspended load transport, differing only in the meaning of K_b .

Once again, however, the value of K_b is difficult to estimate although most sediment transport calculations use a modification of this approach. Sleath (1978) analysed flume measurements of the gross (to and fro) sediment transport rate under waves and obtained an equation with the same functional form as (2.6), but with a linear dependence of transport rate on

wave frequency. Vincent et al. (1981a) analysed the same data but choose a form

$$q \propto [u^2(t) - u_{th}^2] u(t) \quad (2.8)$$

They rationalised this form in a similar manner to that used to derive (2.7); the excess shear stress, proportional to $[u^2 - u_{th}^2]$, lifts sediment off the bed and the instantaneous flow then transports the sediment.

ii) Einstein's Bedload Function

Unlike Bagnold's model, for which interactions between grains are very important, Einstein's approach looks at the detailed force balance on an individual particle and neglects collisions between grains. The differential particle velocity around a particle on the seabed creates a lift force on the particle through the Bernoulli effect. Once off the bed, however, this lift force reduces drastically and the particle falls back to the bed in a free fall trajectory. For bedload movement the average height of this motion is a few grain diameters and the distance travelled is about 100 grain diameters. Einstein also assumed that the probability of grain movement was related to a Gaussian distribution of the lift force about a mean.

Einstein incorporated these ideas into an empirical relationship between a hydraulic parameter and a bedload transport parameter. The details will not be given here but can be found most conveniently in Einstein (1964). Although the physical background to this approach suggests that it should be more applicable to low concentration flows, in fact the method

involves the use of a number of empirically adjusted coefficients which make it more widely applicable (whilst also clouding the physics implied by the technique!).

The shear stress for the Einstein method should be the flat bed stress (although there is some question about whether the laboratory measurements on which the equations are based were really made over flat beds). In principle therefore measured stress should be corrected for form drag before being used in the model; there are no provisions for separation-induced motion.

Brown (1950) suggested a useful simplification of Einstein's bedload function which fits the data well except at very low transport rates. His empirical equation is

$$\phi = 40 \theta^3 \quad (2.9)$$

where $\phi = \frac{\text{volume transport rate}}{\rho w d}$,

w is the sediment fall velocity, and θ is the Shield's parameter.

Madsen and Grant (1977) investigated the possibility of using the Einstein bedload function, in its modified form (Brown 1950), to estimate the total oscillating bedload transport in oscillatory flows. They found that, as with the threshold, the function works well when stress is calculated using the wave friction factors of Jonsson (1966). Their equation for time-varying transport is

$$\begin{aligned} \phi(t) &= 40 \theta^3(t) \frac{\tau(t)}{|\tau(t)|} \quad \text{for } \tau(t) > \text{threshold stress} \\ &= 0 \quad \text{otherwise} \end{aligned} \quad (2.10)$$

Madsen and Grant (1977) argued that (2.10) can be used even in the presence of bedforms if the bed roughness is taken from the grain diameter rather than from the bedform scales. This

procedure, they argued, provides the true skin friction and ignores the form drag contribution to the total stress. Clearly this approach will not be valid where flow separation occurs.

Vincent et al (1981a), and others, have pointed out the importance of the different velocity dependencies of the Bagnold and Einstein approaches to bedload transport. At stresses or velocities significantly above the threshold, Bagnold-type equations have a u^3 dependence whereas the Einstein-Brown equation depends upon u^6 . Since the empirical constants in these equations are generally determined only for a narrow range of velocities, mostly in laboratory flumes, it is clear that their predictions of sediment transport rates in the field may diverge widely.

iii) Yalin's Bedload Equation.

Yalin's approach is very similar to that of Einstein, dealing with a mechanistic model of individual grain motion. It differs in involving the critical stress given by the Shield's diagram explicitly. Again, although starting as an attempt to solve equations for the motion of grains, its final form involves empirical coefficients based on flume experiments. Smith (1977) gave the bedload equation in terms of the volume flux of sediment per unit flow width, Q_s ($=q/\rho$) as

$$Q_s = a_1 u_* S d(1 - [\ln(1 + a_2 S)/a_2 S]) \quad (2.11)$$

where

$$a_1 = 0.635$$

$$a_2 = 2.45 (\rho/\rho_s)^{0.4} (\tau_c/(\rho_s - \rho)gd)^{0.5}$$

$$S = (\tau - \tau_c)/\tau_c$$

When $a_2 S \ll 1$ this reduces to

$$Q_s = a_1 a_2 d u_* S^2 / 2 \quad (2.12)$$

and for quartz sand in seawater this expression can be used for bed stresses less than about 30% above the critical stress.

Again the appropriate stress for this equation is the actual seabed stress. Smith (1977) considered the Yalin equation to be the best method of estimating bedload if used in conjunction with his method of estimating bed stress from total boundary stress (see Section 2.4).

b) SUSPENDED LOAD TRANSPORT

There is still substantial uncertainty about the relative importance of bedload and suspended load transport on continental shelves. For the fine sands of the Washington Shelf, Smith and Hopkins (1972) and Smith (1977) considered bedload transport to be relatively inefficient and suspended transport to be of primary concern, whereas Vincent et al. (1981b) concluded that bedload transport dominates in the New York Bight where medium sands cover much of the seabed.

The most complete technique for estimating suspended transport is to multiply a velocity profile by a profile of suspended sediment concentration and integrate the result over the water depth. Suspension depends upon a balance between the falling of grains under gravity and the upward diffusion of grains by turbulent diffusion in a concentration gradient. By neglecting the effect of sediment on turbulence, Rouse (1937) solved the resulting steady-state, vertical advection-diffusion equation for the log layer to obtain, for sediment concentration

C,

$$C/C_a = [(h-y) a / ((h-a) y)]^p \quad (2.13)$$

where C_a is the concentration at some reference level a , usually taken as the top of the bedload layer, h is the water depth and $p=w/Ku_*$, where K is von Karman's constant. A slightly different expression is obtained by Smith and Hopkins (1972), based on a different form for the diffusion coefficient

$$C/(1-C) = [C_a/(1-C_a)] [a/z]^P \quad (2.14)$$

The more recent coupled sediment/turbulence models of Taylor and Dyer (1977) and Smith and McLean (1977)) should provide more realistic profiles (see Section 2.4).

Note that all of these equations require a value for C_a , the concentration at the bottom of the suspended load region.

Einstein forms the product of the concentration given by (2.13) with a modified logarithmic velocity profile and integrates over the depth to obtain the total suspended sediment transport, giving graphs of the relevant integral functions (Einstein 1964). C_a is given by his bedload function and the reference distance is taken as $a=2d$. In fact since C_a so determined is proportional to the bedload transport rate, bedload and suspended load are generally considered together in a single equation when applying Einstein's method.

Smith (1977) proceeded in a similar manner with his form of concentration profile and provided an equation (his equation 48) from which volume flux of suspended sediment "can be calculated easily on a digital computer or a programmable calculator for the particular p and C_a of concern". He also discussed a

modification of the equation for the case when the sediment extends beyond the log layer. Rather than use a value of C_a from a bedload model, Smith, following Yalin (1963), used a form which depends on the normalised excess shear stress S

$$C_a = C_0 \gamma_s S / (1 + \gamma_s S)$$

where $S = (\tau - \tau_c) / \tau_c$, C_0 is the volume concentration of sediment in the bed, and Γ_s is a constant which was found to be 0.0112 for medium sand (Smith and McLean (1977)). Smith (1977, pg. 565) commented that the inability to compute C_a with any degree of confidence is one of the most fundamental difficulties at present in marine sediment transport.

An alternative approach has been to use empirical equations, devised for river flow, to estimate the average concentration of suspended sediment, and then to multiply this by a representative fluid velocity and water depth. Smith and Hopkins (1972) used expressions of the form

$$C_{av} = (d/h)^{7/6} S F$$

where F is either a function of u_* / w (given by Lausen 1958), or a function of d and gd / u_*^2 (given by Bogardi 1965). They multiplied the resulting values of C_{av} by velocities measured by moored current meters 3 m above the bed. The resulting estimates of transport were typically $6 \text{ m}^3 \text{ hr}^{-1}$ per meter of shelf length for a current of 60 cm s^{-1} .

Although the crude approach used by Smith and Hopkins perhaps represents the best that can be done to estimate suspended sediment transport when very little information is available, it is clear that it can only give a rough estimate (Smith and Hopkins suggest they are within a factor of two or

three, but this is probably optimistic). There is general agreement that inferring suspended transport from a small number of measurements at discrete heights provides very unstable results.

Very little quantitative information is available for predicting suspended sediment transport under combinations of waves and mean flows. Apart from the problem of predicting flow and sediment concentration profiles under oscillatory flow, the presence of ripples on the seabed immensely complicates the situation, as the laboratory experiments of Inman and Bowen (1963) for example, showed. This is discussed more fully in Section 2.4.

Smith (1977) calculates sediment profiles under waves assuming sinusoidal variations in concentration at each level. The implication is that this could be used along with steady flow profiles, perhaps calculated by taking into account the wave/mean flow stresses calculated by Grant and Madsen (see Section 2.4), to estimate net sediment transport. Bagnold's equation for wave/current environments, which was discussed above as a bedload equation, is also perhaps equally applicable to suspended load transport, though it appears to have been tested against field data only in the very nearshore region.

Lesht et al. (1980) avoided the complex calculations inherent in the Smith (1977) scheme by finding an empirical relationship between the concentration of fine sediment in suspension, measured by a transmissometer, and the rms wave orbit speed, both measured 1 m above the seabed off the Long Island

coast. This concentration is then multiplied by an assumed thickness of the suspended sediment layer and multiplied by the mean flow to provide an estimate of suspended sediment transport. A more detailed field measurement of the profile of suspended sediment transport, using an acoustic profiler, is discussed by Vincent et al. (1982). The acoustic profiler provides a high resolution concentration profile over the 1 m distance from the bed to the sensor, and Vincent et al. (1982) multiplied this by a calculated boundary layer velocity profile to estimate suspended sediment transport in this narrow layer.

Bowen (1980) recently applied Bagnold's equations for both bedload and suspended transport to the wave dominated nearshore region assuming that the instantaneous response under time-varying flow can be modelled with the steady flow equations (the same assumption was made by Madsen and Grant when applying Einstein's theory to bedload transport under waves). Initial comparisons with field data are encouraging, but more data are needed to establish the viability of the method.

c) COMPARISONS BETWEEN SEDIMENT TRANSPORT CALCULATIONS

The sediment transport expressions described above are based primarily on laboratory and river measurements, and it is therefore vital that they be tested in continental shelf environments before they can be used with confidence. Unfortunately the difficulty of making sediment transport measurements in the sea, with simultaneous current measurements, has prevented much testing of the equations. Gadd et al (1978) described some comparisons for the New York Bight, using

radioisotopic tracers, but probably the most detailed comparison to date was described by Heathershaw (1981).

Heathershaw (1981) measured sediment transport rates in Swansea Bay, U.K. using radioisotope tracers. Tracer dispersion was monitored at two sites, for 349 days and 155 days respectively. The resulting transport rates were compared with the Einstein bedload equation, the Gadd et al. (1978) form of Bagnold's equation (2.6), Yalin's bedload equation (2.11), an equation due to Ackers and White (1973), and an equation for total load derived by Engelund and Hansen (1967).

Fig. 2.5 shows the results of this comparison. Predictions span nearly two orders of magnitude. Station T2, at a depth of more than 10 m, shows a measured transport rate higher than predicted by most of the models, with the Bagnold equation predicting the closest value. At station T1, a sand bank with a water depth of about 5 m, predictions are much closer to observations but still show a large spread. Of all the predictions, only the Bagnold equation predictions fall consistently within limits that are within a factor of two of the observations.

Heathershaw also conducted a sensitivity analysis of the equations and found that the Bagnold equation is least sensitive to changes in particle size and roughness length whereas the Ackers and White equation is most sensitive.

Vincent et al. (1983) compared predicted transport rates using equations 2.6, 2.8 and 2.10, and found a similar spread among the predictions.

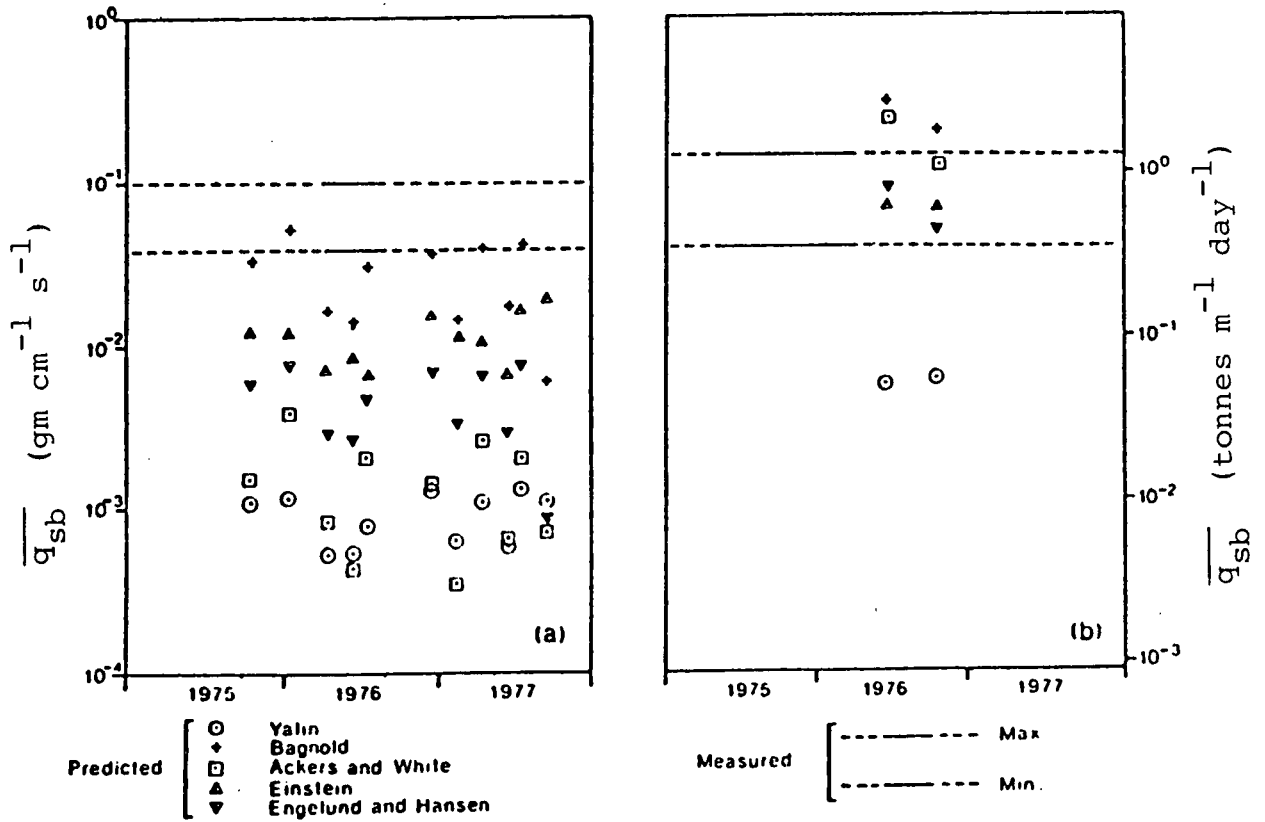

Fig. 2.5 Comparisons of measured and predicted net bedload transport rates ($\overline{q_{sb}}$). The maximum and minimum measured rates are derived from radioactive tracer experiments at T2(a) and T1(b). (after Heathershaw, 1981).

A major problem for long-term models of this kind is how to determine parameters for the influence of waves. Heathershaw (1981) ignored wave effects and argued that they will be small, except near the coast, for his relatively sheltered experimental site. Vincent et al. (1981) in modelling transport rates in New York Bight, implicitly include wave effects by choosing a threshold velocity that is much lower than for the mean flows alone, but this approach is very arbitrary.

In part, the poor performance of the sediment transport models reflects a lack of sufficient temporal resolution of the flow conditions. In addition the adequate calculation of the stress at the seabed remains a major problem, particularly in the presence of waves, currents and bedforms. Improvements in this direction require a better understanding of flow in the bottom boundary layer, and this is the subject of the next section.

2.4 BOTTOM BOUNDARY LAYERS

The object of this section is to review current ideas on methods of estimating the part of the total stress at the seabed that is responsible for sediment motion. Excellent recent reviews of continental shelf boundary layers are by Bowden (1978) and Soulsby (1983).

Two of the most important factors influencing bottom stress on continental shelves are bedforms and the combined presence of waves and currents. We will discuss these separately below.

a) THE FORM DRAG PROBLEM

Bedforms commonly occur in regions of sediment transporting

flows on the continental shelf. These bed features create an internal boundary layer in the flow within which there is an acceleration in the water flow over the crest of the bedform and a deceleration near the trough. If the flow in this internal boundary layer is averaged spatially over a bedform, at fixed heights above the bed, the velocity profile is logarithmic, with a slope related to the boundary shear stress and a roughness length related to the grain roughness of the bed. At a distance greater than about one tenth of a bedform wavelength away from the boundary, the spatial variability of the internal boundary layer has become smoothed out, the flow is uniform and the velocity profile is once again logarithmic. However in this upper region the slope of the logarithmic profile is determined by the average shear stress on the bed plus the force resulting from form drag on the bedform. In other words, the bedforms appear as roughness elements to the flow in the upper region. In the presence of several scales of bedforms, Smith and McLean (1977) found evidence for multiple log layer velocity profiles, each corresponding to a particular bedform scale.

The form drag is the average of the horizontal component of the normal pressure distribution over the bedform, and therefore it does not contribute to sediment transport. Thus, to estimate sediment motion, it is essential to be able to remove the form drag component from any measurement of bottom stress. It is clear from the literature that the importance of this problem has been underestimated until very recently and many of the standard assumptions about sediment transport may have to be modified in

the light of recent results. Numerical models of flow over ripples, such as those of Smith (1969) and Taylor et al. (1976), suggest that for sinusoidal waveforms typically 25 to 33% of the total drag results from form drag. However this percentage is sensitive to the asymmetry of the bedform and to whether separation occurs. Field experiments suggest a much higher proportion for form drag. Smith (1977) found a ratio of total shear stress to skin friction of 5.7:1 for nonseparating flows and 4:1 for separating flows over sand waves in the Columbia River. Chriss and Caldwell (1982), measuring the stress directly in the viscous boundary layer and comparing it with stresses inferred from log profiles above, found ratios of total stress to skin friction ranging from 3.8 to as high as 10.6 on the Oregon Shelf. Although there are too few field measurements to be sure that these ratios are characteristic of conditions on continental shelves, clearly form drag can be a dominant part of the stress except very close to the bed. Some estimates suggest that, to be within the log layer related to true skin friction, measurements have to be within one tenth of a bedform wavelength (SANDS 1977); others suggest within two or three bedform heights (Krugermeyer and Grunwald 1978).

The traditional way to treat this problem, exemplified by Einstein (1964), is to assume that the bedforms are formed by the ambient flow conditions and are in equilibrium with those conditions. In this way the magnitude of the form drag is assumed to be a unique function of the flow. Fig. 2.6 shows Einstein's plot of the friction velocity associated with form drag, u''_{*} , as a function of a hydraulic parameter which is the

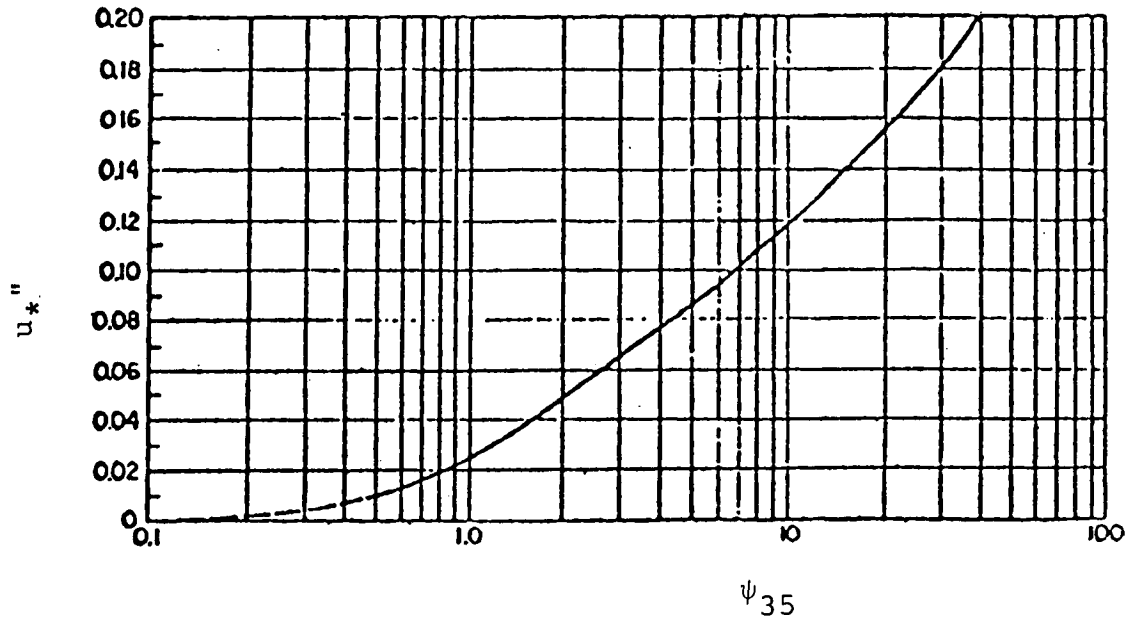

Fig. 2.6 Einstein's (1964) plot of the form-drag component of friction velocity, u_*'' , divided by the velocity above the boundary layer, u , vs. ψ_{35} , which is essentially equal to the (Shield's parameter)¹.

inverse of the Shields parameter. This form drag, or 'bar resistance' as it was called by Einstein, is based primarily on data from rivers and laboratory flumes, and has not been tested in marine environments. Graf (1971) discussed some other estimates of form drag, including some interesting data from Raudkivi (1967) which show that, as might be expected, the form drag component of total stress is greatest for intermediate friction velocities, falling off at low speeds, where bedload transport is weak or non-existent, and at high speeds, where sheet flow flattens down the bedforms. Grant and Madsen (1982) also discussed the estimation of equilibrium ripple steepness when the flow is known.

Generally on the continental shelf, where the flow regime can change much more rapidly than the bedforms, the assumption of equilibrium bedforms is unlikely to be valid. The form drag must therefore be estimated on the basis of what might be rather scanty data on the size and geometry of bedforms in a region. Smith (1977) presented a scheme that can be used when only a single scale of bedform is present. His scheme depends upon matching the water velocity at the height where the lower log layer meets the upper log layer. There are two parameters which must be estimated in order to calculate the ratio of skin friction to total stress; z_* , the height at which the two log layers are matched, and z_t , the apparent roughness length in the upper layer. Following Arya (1975), z_* is taken to be the average height up to which the internal boundary layer diffuses from one roughness element to the next; an equation for air flow

over a warm runway is used to calculate this diffusion distance. Clearly this estimate of z_{\star} is best when the roughness elements are relatively widely spaced. Again following Arya's measurements of air flow over Arctic pressure ridges, Smith estimated z_t using a drag coefficient which, with the height and wavelength of the bedforms, provides an independent estimate of the form drag. Other estimates of z_t are also available. Wooding et al. (1973) presented a general form, based on laboratory and atmospheric data. Lettau (1969) proposed the relation

$$z_t = 0.5 hs/S \quad (2.15)$$

where h is the effective obstacle height, and s is the cross-sectional area seen by the flow per horizontal area S . For two-dimensional ripples s/S approximates the steepness (height/wavelength) which is typically about 0.1. For a ripple of 3 cm height z_t would be about 0.15 cm. With these estimates Smith provided an equation, algebraically messy but straightforward to use, for the ratio of skin friction to total stress.

The input parameters for this scheme are the height and wavelength of the bedforms and the drag coefficient, which is presumably dependent on bedform shape. Unfortunately there are insufficient measurements at present to provide accurate values for the drag coefficient. Smith's own measurements give the drag coefficient, c_d , as 0.15 for separation and 0.70 for no separation over his river sand waves. Chriss and Caldwell (1982) inverted the procedure to estimate the bedform size which would have been responsible for their measured form drag; their results, using a variety of drag coefficients, show that, for a

constant form drag, doubling the drag coefficient halves the estimated bedform height.

Smith and McLean (1977) extend Smith's procedure to allow for multiple log layers, the effect of suspended sediment load on the velocity profile, and the effect of bedload transport on roughness length. The result is a complex iterative scheme allowing skin friction to be found from a knowledge of bedform geometry and velocity profile in one of the upper layers. Their theory appears consistent with their field observations, though there are several very poorly known constants involved which make the scheme hard to use with confidence.

Clearly there is a place for further theoretical and experimental work on this problem. Taylor et al. (1976) and Taylor and Dyer (1977) discuss some aspects of modelling the turbulent boundary layer over a wavy surface (which has obvious connections with the theory of the wind generation of surface waves). As with all turbulence problems, the major difficulty is in specifying the turbulence, but there is hope that increasingly realistic models can be developed soon. Also, the rapidly increasing number of field programs should begin to provide the data against which to assess the theoretical models.

Finally, Dyer (1980) gave an interesting demonstration of the influence of form drag in tidal currents. Since the ripples on the seabed change as the strength of the tidal current changes, he found that apparent bed roughness of the upper layer and total stress change systematically with the stage of the tide. There is even a hysteresis effect between flood and ebb

tides as a result of different ripple sizes.

b) COMBINED WAVE AND CURRENT EFFECTS.

A combination of wind wave currents and mean flows is the most common environment on the continental shelf, particularly during important storms. Field observations (e.g. Butman et al., 1979) showed that sediment movement by waves can occur right out to the edge of the shelf. We might expect waves of period 5 to 15 s to start 'feeling' the seabed in about 20 to 180 m water depth. It is therefore somewhat surprising to find that wave and current boundary layers have received very little attention, at least until recently. Initial investigations centered on finding a formula for a combined wave and current friction factor which would give the correct form in the opposite limits of no waves or no currents (see for example Jonsson, 1966). Other investigations have simply assumed that wave and current effects can be superimposed. Recently two rather similar theoretical studies of wave/current boundary layers have appeared (Smith, 1977 and Grant and Madsen, 1979) and we will briefly discuss these theories in this section.

The wave boundary layer is much thinner than the boundary layer for steady flow. We can therefore distinguish two separate regions in the wave/current boundary layer; a region close to the bed in which both oscillatory and steady friction is important, and a region above in which only the steady flow friction is locally important. It is important to realize, however, that the flow in the upper layer is modified appreciably by the presence of the wave boundary layer; in effect the flow in the upper layer

feels an increased boundary resistance due to the presence of the wave-induced turbulence in the lower layer.

Smith (1977) and Grant and Madsen (1979) independently chose to approach the problem by assuming an eddy viscosity which varies linearly with distance above the bed, but they differ in the form that they take for u_{*} . Smith simply assumed that, within the wave and current boundary layer, u_{*} is the sum of a u_{*wave} (computed from his oscillatory, turbulent boundary layer model) and the steady flow u_{*} , u_{*S} . In the current boundary layer above, the wave component of the eddy viscosity is taken to be constant ($=K u_{*wave} \delta_w$, where δ_w is the thickness of the wave boundary layer. As expected, both mean and oscillatory flows exhibit modified logarithmic layers.

The presence of waves has the apparent effect of increasing von Karman's constant and lowering the ratio of u/u_{*} for a given z/z_0 (height above the bed/boundary roughness length). Thus for a given velocity at a fixed level from the sea bed and a given roughness, a higher mean boundary shear stress results. This effect is significant even for small waves; if $u_{*wave}/u_{*S} = 1/4$ the boundary shear stress is increased by 56%. This enhanced bed stress is very important for sediment transport, particularly as bedload.

Grant and Madsen computed appropriate values of friction velocity in the inner and outer layers by considering the form of the quadratic stress law for a combination of waves and currents. They considered the general case in which wave direction and steady current direction are at an angle to each other. They

also treated the mean flow magnitude and direction in the quadratic stress law as an unknown, because, they argued, the bed shear stress and the relative magnitude of the wave and mean flows are inter-related in a complex non-linear manner so that it is not clear what the appropriate mean current is in the quadratic stress law. Their final scheme for computing the bed stress and velocity profiles, when the wave orbital velocity (outside the wave boundary layer) and the mean flow speed and direction at some given height are known, therefore involves an iterative procedure. Various values of mean flow are tried in the quadratic stress law until the resulting mean flow profile matches the flow speed and direction at the given height above the bed.

As with Smith's theory, they found that the profile of mean flow in the outer region has a modified apparent bottom roughness which can become much larger than z_0 (as the wave amplitude increases relative to mean flow. This prediction of enormously enhanced apparent bottom roughness in the presence of large waves has some support from observations. For example Grant and Madsen quoted results of Forristall et al. (1977) in which bottom roughness as high as 6 m was determined over a mud bottom!

Grant and Madsen claim that their method is most appropriate for a wave-dominated environment, whereas Smith's approach is most appropriate at the opposite extreme of current dominated flows.

Two recent papers provide some support for these theories of enhanced bottom friction, as well as large bottom roughness, from

measurements on continental shelves. Wiberg and Smith (1983) analysed data from the Alaska shelf and found values of friction velocity which are more than twice those predicted for the mean flows alone, but which are in fair, though not excellent, agreement with both the Smith (1977) and Grant and Madsen (1979) models. Grant et al. (1983) reported on the CODE-1 bottom boundary layer experiment on the Northern California shelf. Acoustic travel time current meters measured the three velocity components at 30, 55, 105 and 205 cm off the bed, a pressure sensor was used to monitor wave conditions and other sensors monitored sea bed conditions. Their careful analysis of an extensive data set led them to conclude that, although u_* is more than twice the value predicted by mean flows alone and roughness length z_o is an order of magnitude larger than the physical bottom roughness, the Grant and Madsen (1979) model predictions are typically within 10 to 15% of the observations.

Despite this apparently strong confirmation of the theory, we should beware of assuming that the problem of wave-current interaction is solved. The great sensitivity of the friction velocity, and apparent bed roughness, to bedforms, even isolated bedforms upstream of the measurement point, makes confident interpretation of field results very difficult. There are also laboratory and theoretical studies which throw some doubt on the details of these theories. Kemp and Simons (1982) found, for example, that, for waves propagating with a mean flow over a smooth bottom, the maximum bottom stress can be considered as a linear sum of that due to waves and that due to the mean flow, with an accuracy of around 10%. Higher-order theoretical models

of wave/current boundary layers also suggest that the wave boundary layer is substantially thickened by the presence of a mean flow, an effect which could have a profound influence on sediment transport modelling (R. Soulsby, HRS Ltd., pers. comm., 1985).

c) OTHER COMPLICATIONS

i) Stratification due to sediment load.

When sediment goes into suspension it changes the effective density of the water and leads to an apparent density stratification of the water column. This stratification, if stable (i.e. heavier water below), tends to suppress the turbulence, since it is harder to mix the water vertically. This reduced turbulence in turn affects the velocity profile and the sea bed stress. This phenomenon represents a feedback between the fluid dynamics and the sediment dynamics that is difficult to model.

There is evidence that the effect can be very important locally on the continental shelf, particularly where fine sands and muds are in suspension. Einstein and Chien (1955) made some of the earliest laboratory measurements of this effect and described their results in terms of an effective reduction in von Karman's constant and an increase in effective roughness length. McCave (1973) found similar effects in velocity profiles over a sand bank in the North Sea, and he gave a procedure for modifying von Karman's constant based on his data. Gust (1976) found even more startling results for clay suspensions. Using samples of sediment and sea water from the North Sea in laboratory

experiments, he found that the viscous sublayer increased in thickness by a factor of five and the friction velocity in the log layer above decreased by 40% for a clay suspension. These anomalies appear to result from the elastic deformation of large aggregates of clay particles in the boundary layer.

Taylor and Dyer (1977) used a diffusion-advection model of suspended sediment profile to obtain explicit forms for velocity profile and sediment profile in a coupled sediment-water system (apparently derived previously by Russian workers). Smith and McLean (1977) took a more general non-linear form for the diffusion-advection equation for the suspended sediment profile, but otherwise proceeded in a similar way to Taylor and Dyer. Their results, however, involve finding solutions, by iteration, to equations involving integrals. Since their non-linear form reduces to Taylor and Dyer's linear form in the limit of small sediment concentrations it is easier to use the latter's analytic solution unless sediment concentrations are high.

ii) Bedload Effect on Apparent Roughness Length.

Intense bedload movement of sediment is found to produce high values of z_0 . Smith and McLean (1977), on the basis of their river boundary layer measurements, suggested that the modified roughness length, z_0 , is proportional to the excess shear stress (the shear stress minus the critical stress required for bedload motion):

$$z_0' = 26.4(\tau_b - \tau_c) / (\rho_s - \rho)g + z_0 \quad (16)$$

Grant and Madsen (1982) gave a rather more complex expression which combines the bedload effect with the influence of bottom

bedforms. Gust and Southard (1983), on the other hand, suggested major changes to the nature of the boundary layer once bedload transport occurs.

iii) Stress Intermittency.

The velocity shear in the benthic boundary layer is intrinsically unstable and, except for a viscous layer adjacent to the bed over smooth seabed is turbulent. The dimensional arguments and scaling used in relation to turbulent boundary layers are poor substitutes for a proper physical understanding of the nature of the turbulence. Recent laboratory research has returned to a more descriptive study of the form of turbulent motion using flow visualisation techniques and very detailed velocity measurements. The results are revealing organized structures of flow in turbulent boundary layers, a particularly important form being bursts of low velocity fluid ejected from close to the boundary, and of high velocity fluid penetrating down into a boundary layer with a sweeping motion (see Cantwell, 1981 for a comprehensive review).

The significance of these observations to continental shelf boundary layers is that the bed stress is found to be strongly related to these intermittent "burst" phenomena. High frequency measurements of stress by the eddy correlation method show that the short, intermittent bursts give very high values of stress, and stress is negligible between bursts. Heathershaw (1974), for example, found that 57% of the stress occurred in the 7% of the time associated with bursts; peak values of stress reached as high as 30 times the mean stress. Thus the stress used in the

formulae above is the mean of a highly irregular distribution of stress events. Scaling laws to determine the average time interval between these bursts of high stress have been quite well tested; typically bursts will be a few tens of seconds apart, but for some flows the interval can reach several minutes. The implication of this intermittancy is, clearly, that an accurate measurement of the true average stress in the turbulent boundary layer requires measurements that span a long time interval, so that the average can be made over many stress events.

Heathershaw and Simpson (1978) found a variability of an estimated 50% in the stress measured over 600s. Interestingly, they argued that, in changing tidal currents, there is not the option of extending the averaging time to reduce this variability significantly since the flow cannot be considered steady for longer periods. There appears therefore to be an intrinsic uncertainty in the mean stress during a tidal cycle.

(iv) Wave-current-bedform Effects

When a steady flow over steep ripples separates in the lee of the ripples, forming vortices, there is a significant change in form drag (Smith and McLean, 1977). Similar separation can occur under oscillatory flows, but the resulting vortex patterns are much more complex and the implications for sediment transport are profound, and often surprising.

Longuet-Higgins (1981) described the formation of vortices resulting from symmetric oscillatory flow over symmetric ripples and was able to reproduce theoretically many of the observations of Bagnold (1963) and others. In this symmetric case there is no

net sediment transport. Under waves in the ocean, however, there may be asymmetry of the oscillatory velocity, asymmetry of the ripple profile, and mean flows may be present, both wave-induced and separately imposed. The laboratory flume results of Inman and Bowen (1963) and Bijker et al. (1976) give a flavour of the complexities that can occur in these cases.

Inman and Bowen (1963) found, for example, that although for waves alone the mass transport of sediment and the ripple migration were, as expected, in the direction of propagation of the waves, a small superimposed mean flow also in the direction of propagation of the waves could cause upstream sediment transport and upstream migration of ripples. This surprising result occurred because the added mean flow strengthened the vortex formed on the downstream-facing side of the ripples during the forward flow, and the extra sediment entrained in this vortex was carried upstream during the backward flow portion of the wave cycle. As they remark, this phenomenon can occur only for a range of small mean flows and must be reversed as the mean flow increases. However the magnitude of their mean flow, a few centimeters per second, was comparable with wave-induced flows so the effect may be significant in field situations.

Bijker et al. (1976) conducted similar experiments but emphasized the importance of wave velocity symmetry. They found net sediment transport in the direction of the wave propagation if the front face of the wave is steeper than the back face and backward transport if the back face is steeper. This observation is consistent with the application of Bagnold's theory to oscillatory flows by Bowen (1980). They also found that the

direction of sediment transport can be reversed by a small superimposed mean flow. They concluded, not unreasonably, that an understanding of vortex formation as a function of wave and flow parameters is essential for a proper modelling of sand transport by waves and currents over steep ripples.

Although these separation effects are probably most important in the nearshore region, where wave velocities are large, they may also be significant at least in the inner regions of continental shelves and over shallow banks. A major problem with using laboratory results to predict field conditions is the notorious difficulty of controlling secondary mean flows, standing waves and higher frequency waves in flumes. Thus it is likely that careful field measurements will be needed to determine parameters for these effects appropriate for continental shelf conditions.

2.5 SUMMARY AND DISCUSSION OF FUTURE RESEARCH NEEDS

Despite its title, it is clear from the contents of this chapter that, for the most part, existing methods of estimating sediment transport rates on continental shelves come not from a proper physical understanding but from a fundamentally unsatisfactory combination of dimensional arguments and empirical results. Consequently, scientists and engineers are rather poorly equipped to predict sediment transport rates to the quantitative accuracy frequently needed by those operating on continental shelves.

Perhaps the most obvious reason for this inadequacy is the

large variability of measurements made both in laboratory flumes and in the field. Thus, for example, it is difficult to assess accurately the influences on the threshold stress of such factors as biological activity (Grant et al., 1982) and waves (Madsen and Grant, 1975) because the scatter of data from simple flow situations appears to be great enough to encompass these more complex effects. As another example, Hallermeier (1982) attempted, with at least partial success, to draw together data for oscillatory bedload transport from a wide range of conditions into a single bedload equation, a technique probably possible only because of the wide spread of data, even on a log-log plot.

There appear to be two major reasons for this variability: the inherently stochastic nature of boundary layer processes and the imprecise definitions of many of the parameters being measured.

Firstly, sediment transport takes place within the boundary layer where, as discussed in Section 2.4, the stresses and velocities are irregular and unpredictable except in a statistical sense. The observations of Heathershaw and Simpson (1978) show the important influence this irregularity can have on evaluation of mean stresses. On the other hand, large scale sediment transport measurements, for example using tracers, tends to be much less sensitive to this variability because results depend on spatial averaging. Thus a comparison between predictions based on point measurements of velocity and tracer measurements of sediment transport rates shows the scatter in the stress measurements. As another example, the statistical variability of stress causes a broad spread about the mean threshold stress

or velocity (Davies and Wilkinson, 1979).

Surprisingly, only the Einstein theory for sediment transport explicitly takes into account the statistical nature of the stresses and the resulting equations are generally not considered good predictors in practice, as we have seen. What is needed is a better determination of parameters describing the statistical variability of bottom stresses and their influence on bottom sediments. Interest is currently focussed on the organized structures now known to exist in turbulent boundary layers (for a review see Cantwell, 1981), and on their importance for sediment transport (e.g. Jackson, 1976). Progress in incorporating these structures into practical theories of boundary layers is slow and the connection to a truly predictive theory has not yet been made. Nevertheless more detailed field measurements of boundary layer turbulence are gradually building up a picture of the structured events which should eventually allow a much better prediction of the boundary flows and hence of sediment transport.

Secondly, the "fuzziness" of our definitions of sediment transport parameters is most clearly illustrated by that for the threshold of sediment motion. It is unreasonable to assume that a threshold defined by watching a close-up video film of sediment on the sea bed will be the same as a threshold defined by the existence of sediment in the path of a nephelometer a number of centimeters, or even tens of centimeters, above the bed. The link between these should, however, be susceptible to theoretical modelling. Similar "fuzziness" arises due to the broad range of

spatial and temporal averages taken when estimating sediment transport. These and other factors contribute to the scatter of results.

In addition to the scatter in the existing databases, our predictive ability is also limited by the paucity of field data against which to test predictions, though this is slowly being corrected. Such field measurements are, of course, very difficult to make. Recent measurements with radio-isotopic tracers (e.g. Heathershaw, 1981) provide the best data on large scale transport to date, though interpretation of the results may be complicated by differing burial patterns of the tracers and by wide dispersal. On a smaller scale the acoustic instrumentation discussed by Vincent et al. (1982) provides profiles of suspended sediment concentration which, when combined with current measurements, perhaps using acoustic techniques too, should give estimates of suspended sediment transport above a point on the seabed. There is as yet, however no instrumentation capable of making measurements of bedload transport on a similarly small scale. Since there is considerable uncertainty as to the relative importance of bedload and suspended load transport, this is a serious gap in available instrumentation. Suggested techniques for measuring bedload transport on small scales should be pursued (see Chapter 5).

Specific areas in which further research is needed include the study of bedform effects, wave and current boundary layers, and the influence of biological activity.

As discussed above, bedforms cause the awkward addition of a form drag component to the total stress measured some distance

above the bed. This form drag component must be subtracted from the total stress to obtain the skin friction used in sediment transport equations. Recent measurements suggest that the form drag may be up to ten times larger than the skin friction component, but further research is needed to relate accurately such large values to bedform shapes, either theoretically or empirically. In addition bedforms have a complex interaction with waves and currents, and sediment transport patterns may be counter-intuitive. Although laboratory studies are important in studying these effects, problems associated with controlling mean flows in flumes suggest that field measurements are also needed.

Boundary layers under combined wave and steady currents are the most common boundary layers over most of the continental shelf, at least during the storm events which are responsible for most sediment transport. Recent theories have advanced our understanding of such boundary layers considerably, but there are still major uncertainties concerning the validity of the theories, particularly in the predicted thickness of the wave boundary layer. Measurements by Lambrakos (1982) and the height of resuspended sediment plumes under waves (Vincent et al., 1982) argue for a much thicker wave boundary layer than generally predicted. It is also unclear how the monochromatic wave theories will perform in a field situation where a spectrum of waves exists.

Biological effects are important locally, particularly in shallow water. However the question of just how widespread and important biological modifications of bottom sediment are is as

yet a difficult question to answer.

In summary, major advances have been made in recent years in field instrumentation, laboratory studies and theories relating to the prediction of sediment transport. Our understanding of the details of bottom boundary layer flow and the sediment motion in the boundary layer continues to grow. However we are only just beginning to incorporate some of these ideas into predictive models for large scale sediment transport. Such large scale transport is likely to remain unpredictable to a large degree, simply because detailed knowledge of the environment will generally not be available. Nevertheless, some of the ideas discussed in this chapter show considerable promise for significant improvements in predictive techniques in the future.

2.6 REFERENCES

- Ackers, P. and W.R. White, 1973. Sediment transport: new approach and analysis. Proc. Am. Soc. Civ. Eng., J. Hydraulics Division, HY 11, 2041-2060.
- Arya, S.P.S., 1975. A drag partition theory for determining the large scale roughness parameter and wind stress on the Arctic pack ice. J. Geophys. Res. 80, 3447-3454.
- Bagnold, R.A., 1963. Mechanics of marine sedimentation. in The Sea. M.N. Hill (ed.). Vol. 3 Wiley-Interscience. N.Y.
- Bagnold, R.A., 1966. An approach to the sediment transport problem from general physics. U.S. Geol. Survey Prof. Paper 422-I, 37 pp.
- Bijker, E.W., E.V. Hijum and P. Vellinga, 1976. Sand transport by waves. Proc. 15th Coastal Engineering Conf. Hawaii. Chap. 68, 1149-1167. Am. Soc. Civ. Engrs. N.Y.
- Blatt, H., G. Middleton and R. Murray, 1980. Origin of Sedimentary Rocks. Prentice-Hall, New Jersey. 782 pp.
- Bogardi, J.L., 1965. European concepts of sediment transportation. Proc. Am. Soc. Civil Engineers. 91 (HYI), 29-54.
- Bowden, K.F., 1978. Physical problems of the benthic boundary layer. Geophysical Surveys 3, 255-296.
- Bowen, A.J., 1980. Simple models of nearshore sedimentation; beach profiles and longshore bars. in The Coastline of Canada. S.B. McCann (ed.). Geological Survey of Canada, Ottawa. 1-11.
- Brown, C.B., 1950. Sediment Transportation. in Engineering Hydraulics, H. Rouse (ed.). Wiley, N.Y.
- Butman, B., M. Noble and D.W. Folger, 1979. Long-term observations of bottom current and bottom sediment movement on the mid-Atlantic continental shelf. J. Geophys. Res. 84, 1187-1205.
- Cantwell, B.J., 1981. Organised motion in turbulent flow. Ann. Rev. Fluid Mech. 13, 457-515.
- Chriss, T.M. and D.R. Caldwell, 1982. Evidence for the influence of form drag on bottom boundary layer flow. J. Geophys. Res. 87, 4148-4154.
- Davies, A.G. and R.H. Wilkinson, 1979. Sediment motion caused by surface water waves. Proc. 16th Conf. Coastal Eng., ASCE, N.Y., 1577-1595.

- Dyer, K.R., 1980. Velocity profiles over a rippled bed and the threshold of movement of sand. Estuarine and Coastal Mar. Sci. 10, 181-199.
- Einstein, H.A., 1964. River sedimentation. in V. Te Chow (ed.). Handbook of Applied Hydrology. McGraw-Hill, N.Y. Section 17-II, 35-67.
- Einstein, H.A. and N. Chien, 1955. Effects of heavy sediment concentration near the bed on velocity and sediment distribution. U.S. Army Corps of Engineers, Missouri River Division. Sediment Series 8. 76 pp.
- Engelund, F. and E. Hansen, 1967. A monograph on sediment transport in alluvial streams. Technisk-Vorlag, Copenhagen. 62 pp.
- Forristall, G.Z., R.C. Hamilton and V.T. Cardone, 1977. Continental shelf currents in tropical storm Delia: Observations and theory. J. Phys. Oceanogr. 7(4), 532-536.
- Gadd, P.E., J.W. Lavelle and D.J.P. Swift, 1978. Estimates of sand transport on the New York shelf using near-bottom current meter observations. J. Sed. Pet. 48, 239-252.
- Graf, W.H., 1971. Hydraulics of sediment transport. McGraw-Hill, N.Y., 513 pp.
- Grant, W.D. and O.S. Madsen, 1979. Combined wave and current interaction with a rough bottom. J. Geophys. Res. 84, 1797-1808.
- Grant, W.D., L.F. Boyer and L.P. Sanford, 1982. The effect of bioturbation on the initiation of motion of intertidal sands. J. Marine Res., 40, 659-677.
- Grant, W.D. and O.S. Madsen, 1982. Movable bed roughness in unsteady oscillatory flow. J. Geophys. Res. 87, 469-481.
- Grant, W.D., A.J. Williams, 3rd, S.M. Glenn, D.A. Cacchione and D.W. Drake, 1983. High frequency bottom stress variability and its prediction in the CODE region. CODE technical report number 15. Woods Hole Oceanographic Institution, Woods Hole, Mass.
- Grass, A.J., 1970. Initial instability of fine bed sand. Amer. Soc. Civil Engineers Proc., V. 96 (HY3), 619-632.
- Gust, G., 1976. Observations on turbulent drag reduction in a dilute suspension of clay in sea-water. J. Fluid Mech. 75, 29-47.
- Gust, G., and J.B. Southard, 1983. Effects of weak bedload on

- the universal law of the wall. J. Geophys. Res. 88
5939-5952.
- Hallermeier, R.J., 1982. Oscillatory bedload transport: Data review and simple formulation. Continental Shelf Res. 1, 159-190.
- Heathershaw, A.D., 1974. Bursting phenomena in the sea. Nature 248, 394-395.
- Heathershaw, A.D. and J.H. Simpson, 1978. The sampling variability of the Reynolds stress and its relation to boundary shear stress and drag coefficient measurements. Estuarine and Coastal Marine Science. 6, 263-274.
- Heathershaw, A.D., 1981. Comparisons of measured and predicted sediment transport rates in tidal currents. Mar. Geol. 42, 75-104.
- Hill, P.R. and A.J. Bowen, 1983. Modern sediment dynamics at the shelf-slope boundary layer off Nova Scotia, in Stanley, D.J. and G.T. Moore (eds.) The Shelfbreak: Critical Interface on Continental Margins. SEPM Spec. Pub. 33, 265-278.
- Inman, D.L., 1963. Sediments: Physical properties and mechanics of sedimentation, p.101-151 in Submarine Geology (F.P. Shepard, ed.) Chapter V, 2nd Ed., Harper and Row, N.Y. 963 p.
- Inman, D.L. and R.A. Bagnold, 1963. Littoral processes. p.529-553 in The Sea. M.N. Hill (ed.). Vol. 3. Wiley-Interscience, 963 p.
- Inman, D.L. and A.J. Bowen, 1963. Flume experiments on sand transport by waves and currents. Proc. 8th Conf. Coastal Engrg. ASCE, N.Y., 137-150.
- Inman, D.L., G.C. Ewing and J.B. Corliss, 1966. Coastal sand dunes of Guerrero Negro, Baja California, Mexico. Geol. Soc. Am. Bull. 77, 787-802.
- Jackson, R.G. II, 1976. Sedimentological and fluid dynamic implications of the turbulent bursting phenomenon in geophysical flows. J. Fluid Mech. 77, 531-560.
- Jonsson, I.G., 1966. Wave boundary layers and friction factors. Proc. 10th Coastal Eng. Conf. Vol. 1. 127-148. ASCE, N.Y.
- Kachel, N.B. and R.W. Sternberg, 1971. Transport of bedload as ripples during an ebb current. Marine Geol. 19, 229-244.
- Kemp, P.H. and R.R. Simons, 1982. The interaction between waves and a turbulent current: waves propagating with

- the current. J. Fluid Mech. 116, 227-250.
- Komar, P.D. and M.C. Miller, 1973. The threshold of sediment movement under oscillatory water waves. J. Sed. Petrology 43, 1101-1110.
- Komar, P.D. and M.C. Miller, 1975. On the comparison between the threshold of sediment motion under waves and unidirectional currents with a discussion of the practical evaluation of the threshold. J. Sed. Petrology 45, 362-367.
- Krugermeyer, L. and M. Grunwald, 1978. The influence of sea waves on the wind profile. Boundary Layer Meteorology. 10, 403-414.
- Lambrakos, K.F., 1982. Seabed wave boundary layer measurements and analysis. J. Geophys. Res. 87, 4171-4189.
- Langhorne, D.N., 1981. An evaluation of Bagnold's dimensionless coefficient of proportionality using measurements of sand-wave movement. Marine Geol. 43, 49-64.
- Larsen, L.H., R.W. Sternberg, N.C. Shi, M.A.H. Marsden and L. Thomas, 1981. Field investigations of the threshold of grain motion by ocean waves and currents. Mar. Geol. 42, 105-132.
- Lausen, E.M., 1958. The total sediment load of streams. Proc. Am. Soc. Civil Engineers, 84 (HYI), 1530.
- Lesht, B.M., T.L. Clarke, G.L. Freeland, D.J.P. Swift and R.A. Young, 1980. An empirical relationship between the concentration of resuspended sediment and near-bottom wave orbital velocity. Geophysical Research Letters. 2, 1049-1052.
- Lettau, H., 1969. Note on aerodynamic roughness - parameter estimation on the basis of roughness element description. J. Applied Meteorology, 8, 828-832.
- Longuet-Higgins, M.S., 1981. Oscillatory flow over steep sand ripples. J. Fluid Mech. 107, 1-35.
- Madsen, O.S. and W.D. Grant, 1975. The threshold of sediment movement under oscillatory water waves: A discussion. J. Sed. Petrology 45, 360-361.
- Madsen, O.S. and W.D. Grant, 1977. Quantitative description of sediment transport by waves. Proc. 15th Coastal Eng. Conf. Vol. 2. 1093-1112.
- McCave, I.N., 1973. Some boundary layer characteristics of tidal currents bearing sand in suspension. Mem. Soc. Roy. Sci. Liege. 6 ser., 6, 107-126.

- Middleton, G.V., 1976. Hydraulic interpretation of sand size distributions. *J. Geology* 84, 405-426.
- Middleton, G.V. and J.B. Southard, 1977. Mechanics of sediment movement. SEPM Short Course No. 3. Tulsa, Oklahoma. Society of Economic Palaeontologists and Mineralogists.
- Miller, M.C., I.N. McCave and P.D. Komar, 1977. Threshold of sediment motion under unidirectional currents. *Sedimentology* 24, 507-527.
- Nowell, A.R.M., P.A. Jumars and J.E. Eckman, 1981. Effects of biological activity on the entrainment of marine sediments. *Marine Geol.* 42, 133-153.
- Raudkivi, A.J., 1967. Loose boundary hydraulics. Pergamon, Oxford.
- Rhoads, D.C., 1974. Organism-sediment relations on the muddy sea floor. *Oceanogr. Mar. Biol. Annu. Rev.* 12, 263-300.
- Rouse, H. 1937. Modern conceptions of the mechanics of turbulence. *Transactions of the American Society of Civil Engineers* 102, 436-505.
- SANDS, 1977. Shelf Sediment Dynamics: A national overview. ed. D.S. Gorsline and D.J.P. Swift. Report of a workshop held in Vail, Colorado, Nov. 2-6, 1976, NSF (IDOE).
- Shields, A., 1936. Anwendung der Ähnlich keitsmechanik und Turbulenzforschung auf Geschiebsebewegung. *Mitteil. Preuss. Versuchsanst; Wasser, Erd, Schiffsbau, Berlin*, no. 26.
- Sleath, J.F.A., 1978. Measurements of bedload in oscillatory flow. *J. Waterways Port, Coastal Ocean Division Proc. Am. Soc. Civil Engrs.* 104 WW4, 291-307.
- Smith, J.D., 1969. Investigations of turbulent boundary layers and sediment transport phenomena as related to shallow marine environments. Part 2. Studies of non-uniform boundary layer flows. Report A 69-7. Dept. of Oceanogr. U. of Washington.
- Smith, J.D. and T.S. Hopkins, 1972. Sediment transport on the continental shelf off Washington and Oregon in light of recent current measurements. *in* D.J.P. Swift, D.B. Duane and O.H. Pilkey (eds.). *Shelf Sediment Transport*. Dowden, Hutchinson and Ross. Stroudsburg, Pa., 143-180.
- Smith, J.D., 1977. Modeling of sediment transport on continental shelves. *in* *The Sea*. Vol. 6 E.D. Goldberg, I.N. McCave, J.J. O'Brien and J.H. Steele (eds.) Wiley-Interscience. Chapter 13: 539-577.

- Smith, J.D. and S.R. McLean, 1977. Spatially averaged flow over a wavy surface. *J. Geophys. Res.* 82, 1735-1746.
- Sternberg, R.W., 1971. Measurements of incipient motion of sediment particles in the marine environment. *Marine Geology* 10, 113-119.
- Sternberg, R.W., 1972. Predicting initial motion and bedload transport of sediment particles in the shallow marine environment. *in* D.J.P. Swift, D.B. Duane and O.H. Pilkey (eds.). *Shelf Sediment Transport*. Dowden, Hutchinson and Ross Inc., Stroudsburg, Pa., 61-82.
- Taylor, P.A., P.R. Gent and J.M. Keen, 1976. Some numerical solutions for turbulent boundary-layer flow above fixed, rough, wavy surfaces. *Geophys. J. Royal Astronom. Soc.* 44, 177-201.
- Taylor, P.A. and K.R. Dyer, 1977. Theoretical models of flow near the bed and their implications for sediment transport. *in* *The Sea*. Vol. 6, E.D. Goldberg, I.N. McCave, J.J. O'Brien and J.H. Steele (eds.). Wiley-Interscience, N.Y. Chapter 14: 579-601.
- Vincent, C.E. R.A. Young and D.J.P. Swift, 1981a. Bedload transport under waves and currents. *Marine Geol.* 39 M71-M80.
- Vincent, C.E., D.J.P. Swift and B. Hillard, 1981b. Sediment transport in the New York Bight, North American Atlantic Shelf. *Mar. Geol.* 42, 369-398.
- Vincent, C.E., R.A. Young and D.J.P. Swift, 1982. On the relationship between bedload and suspended sand transport on the inner shelf, Long Island, New York. *J. Geophys. Res.* 87, 4163-4170.
- Vincent, C.E., R.A. Young and D.J.P. Swift, 1983. Sediment transport on the Long Island shoreface, North American Atlantic Shelf: role of waves and currents in shoreface maintenance. *Continental Shelf Res.* 2, 163-182.
- Wiberg, P. and J.D. Smith, 1983. A comparison of field data and theoretical models for wave-current interactions at the bed on the continental shelf. *Continental Shelf Res.* 2, 147-162.
- Wooding, R.A., E.F. Bradley and J.K. Marshall, 1973. Drag due to regular arrays of roughness elements of varying geometry. *Boundary Layer Meteorology* 5, 285-308.
- Yalin, M.S., 1963. An expression for bed load transportation. *J. Hydraulic Division. Proc. Am. Soc. Civ. Eng.*, 89 (NY3) 221-250.

CHAPTER 3

WAVE INDUCED PORE WATER PRESSURES
AND SEAFLOOR STABILITY

by

W.D. LIAM FINN

University of British Columbia

3.1 INTRODUCTION

The stability of the seafloor under the action of storm waves is an important consideration in the design of pipelines, anchors, and offshore structures such as gravity and pile supported platforms. The interaction of ocean and seafloor is a very complex problem and all methods for assessing stability are based on extensive simplifying assumptions. Storm waves are almost invariably represented as a series of harmonic waves (Fig. 3.1). These waves create dynamic pressure waves on the ocean floor, increasing the pressure under the crest and reducing it under the trough. The harmonically varying pressure amplitude, p_b , is usually determined by linear wave theory assuming the seafloor to be rigid and impermeable, and is given by the following equations

$$p_b = p_o \sin (\lambda x - \omega t) \quad (3.1)$$

$$p_o = \frac{\gamma_w H}{2 \cosh \lambda d} \quad (3.2)$$

in which p_o = amplitude of wave pressure on the seafloor; γ_w =

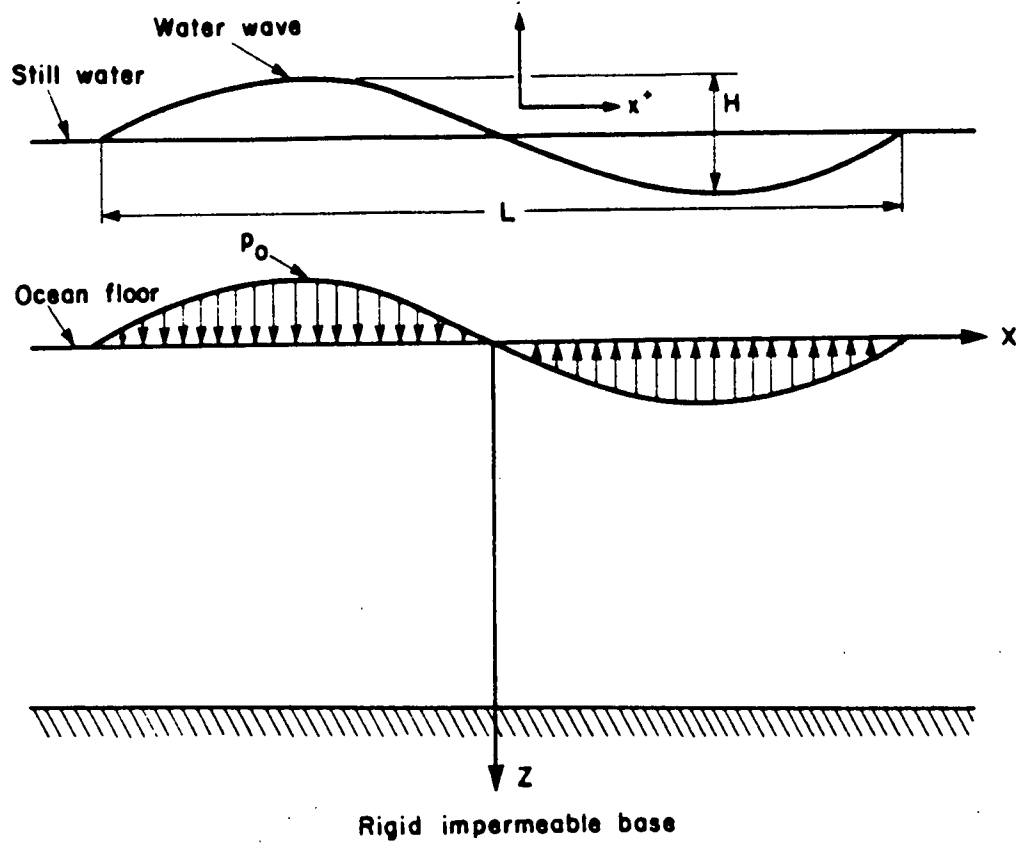

Fig. 3.1 Wave pressures on ocean floor.

unit weight of water; λ = wave number, $2\pi/L$; L = wave length; d = depth of water; and ω circular frequency (Fig. 3.1). Mallard and Dalrymple (1977) analysed the effects of a deformable seafloor on dynamic pressure amplitudes. Their analysis predicts that pressures on a deformable impermeable seafloor are higher than those on a rigid base. The increases may be significant for very soft cohesive sediments (increases up to 15% are quoted), but may be ignored for most sands.

The differential loading of the seafloor by the pressure wave creates shear stresses in the underlying soil and, if these exceed the shear strength, significant deformations or a stability failure may occur. Henkel (1970) was one of the first to provide an analytical framework for stability analyses under wave loading. He assumed that failure occurred along a circular slip surface and examined the limiting equilibrium state of clay slopes for undrained loading conditions, taking into account wave-induced pressures, gravity loads, and the undrained strength of the soil. His contribution is historically important because he demonstrated conclusively that the pressure changes on the seafloor induced by storm waves could be a significant factor affecting seafloor stability.

The stability of seafloor cohesionless soils such as sands, is a more complex problem requiring effective stress stability analyses for a proper understanding of all the phenomena involved. A framework for effective stress stability analyses has been presented by Finn and Lee (1979). The method assumes that pore water pressures can be determined by an independent

procedure uncoupled from stress or stability analysis.

Both transient and residual pore water pressures are generated in seafloor sands by wave loading. The transient pore water pressures result from the coupled instantaneous response of the sand skeleton and the pore water to wave loads. At any time there is a unique one-to-one relationship between pore water pressure and applied loads. Residual pore water pressures are caused by the cyclic shear stresses generated by the dynamic wave pressures varying harmonically in space and time. These pore water pressures are not uniquely related to instantaneous values of the wave induced stresses but also depend on the intensity and duration of loading and the drainage characteristics of the seafloor.

The prediction of transient pore water pressures has attracted attention from a large number of investigators. The first, Putnam (1949), assumed the sand skeleton to be incompressible and hydraulically isotropic, the flow to be governed by Darcy's law, and the seawater to be incompressible. With some minor adjustments, it will be shown later that this simple solution has very wide applicability.

Madsen (1978) and Yamamoto (1977, 1978) have developed analyses for the effective stresses and transient pore water pressures in a sand due to wave loading, using Biot's equations (1941) for a poroelastic solid. They used the Mohr-Coulomb yield criterion to determine the region of the seafloor over which the wave induced effective stresses may result in failure or transient instability.

Siddharthan and Finn (1979a) programmed a solution to a

general form of Biot's equations in the computer program STAB-MAX. They also used the Mohr-Coulomb yield criterion to delimit regions of instability. Yamamoto (1983) included Coulomb damping in the equations for the poroelastic solid and Yamamoto, Takahashi and Schuckman (1983) extended this work to include non-linear elastic response in the soil structure.

The mechanism by which residual pore water pressures are generated by cyclic shear stresses has been described by Martin, Finn and Seed (1975). The levels of pore water pressure in the seafloor depend on the intensity and duration of storm loading and the relative rates of generation and dissipation. Since storms may last for several hours or more, dissipation effects are very important and must be taken into account in order to obtain reliable estimates of residual pore water pressures. The pore water pressures may lead to liquefaction of the seafloor sands. Liquefaction may result in the flotation of pipelines (Christian et al., 1974), loss of anchor resistance, loss of significant lateral resistance of piles (Finn and Martin 1979, 1980), and slope failures in soil structures such as the artificial islands used for oil and gas exploration in the Beaufort Sea (Finn, Iai, and Ishihara, 1982). Seed and Rahman (1977) have presented a procedure for estimating residual pore water pressures and liquefaction potential under wave loading. It is an adaptation to ocean wave loading conditions of the simplified procedure for estimating liquefaction potential under earthquake loading developed by Seed, Martin and Lysmer (1976).

Siddharthan and Finn (1979b) generalized the Seed-Rahman

method to include the effects of pore water pressures on soil properties during analysis. The method is incorporated in the computer program STAB-W. Yogendrakumar, Siddharthan and Finn (1983) improved the description of the pore water pressure distribution by using higher order finite elements in the program STAB-W3.

For specified soil conditions and wave climate, the stability of the seafloor is controlled by the transient and residual pore water pressures. The various methods of estimating these pressures and incorporating them in stability analyses are critically reviewed below.

3.2 TRANSIENT PORE WATER PRESSURES AND STRESS STATES

a) COUPLED EFFECTIVE STRESS ANALYSES

(i) Yamamoto-Madsen Analyses.

Biot (1941) presented a general theory for a poroelastic solid which takes into account the elastic deformation of the porous medium, compressibility of the pore fluid and Darcy flow. Yamamoto (1977, 1978) and Madsen (1978) have used Biot's theory to analyse the response of the seafloor to harmonic wave loading. Yamamoto assumed hydraulic isotropy and analysed deposits of both infinite and finite depth. Madsen extended the analysis to include hydraulic anisotropy in the case of infinite depth.

The governing equations for the poroelastic solid are presented to illustrate the coupling between soil and water and to provide a basis for discussing the role of permeability and compressibility. For plane strain conditions the equations are

$$k_x \frac{\partial^2 p}{\partial x^2} + k_z \frac{\partial^2 p}{\partial z^2} - \gamma_w n \frac{\beta \partial p}{\partial t} = \gamma_w \frac{\partial(\epsilon_x + \epsilon_z)}{\partial t} \quad (3.3)$$

in which k_x, k_z = the principal permeabilities in the x and z directions, respectively;

p = the excess pore pressure;

γ_w = the unit weight of pore water;

n = the porosity of the bed;

ϵ_x and ϵ_z = the normal strains ($\epsilon_y = 0$) defined to be positive as elongations, and

t = time.

The compressibility of pore water, β , is given by

$$\frac{\partial p}{\partial t} = \rho \beta \frac{\partial p}{\partial t} \quad (3.4)$$

in which ρ = the density of pore water.

Incremental equilibrium equations in x and z directions can be written as

$$\frac{\partial \sigma'_x}{\partial x} + \frac{\partial \tau_{xz}}{\partial z} = - \frac{\partial p}{\partial x} \quad \text{and} \quad \frac{\partial \sigma'_z}{\partial z} + \frac{\partial \tau_{zx}}{\partial x} = - \frac{\partial p}{\partial z} \quad (3.5)$$

in which σ'_x, σ'_z and τ_{xz} = the incremental effective stresses and shear stresses.

The boundary conditions for an infinitely thick seafloor are (Fig. 3.1)

$$\sigma'_z = \tau_{xz} = 0; \quad p = p_0; \quad \text{at } z = 0 \quad (3.6)$$

and the displacements and pore water pressure vanish at infinity.

Madsen (1978) has provided a solution to this problem in great detail.

The term on the right hand side of (3.3) represents the rate of change of volumetric strain under wave loading. Some of this strain will be accommodated by drainage and the remainder by

compression of the pore water. Compression of the pore water gives rise to a pore water pressure p , the value of which depends on the bulk modulus of the water, $K = 1/\beta$. The effective bulk modulus of the pore fluid in soils K' is very dependent on the gas content or the degree of saturation S . A lower bound for the effective bulk modulus of the pore fluid has been given by Verruijt (1969) as

$$\frac{1}{K'} = \frac{1}{K} + \frac{1-S}{P} \quad (3.7)$$

in which S = degree and saturation of P is the absolute pore fluid pressure. If P is taken as 1 atm or 100 kN/m^2 , then the effective bulk modulus drops by a factor 10^3 from the order of 10^9 kN/m^2 to 10^6 kN/m^2 as the degree of saturation drops from 100% to 95%. Therefore the presence of air in soil pores will significantly reduce the magnitude of pore water pressure that may develop and hence, through (3.5) and (3.3), the effective stresses that may be generated by wave loading.

It is clear from (3.3) that the pore water pressures will also be affected by the ratio of the permeabilities k_x/k_z , the anisotropic permeability ratio.

Madsen (1978) used his analytical solution for the infinitely thick seafloor to explore the effects of ranges in compressibility and anisotropic permeability ratio. He concluded, for this case, that

- (1) solutions are very sensitive to the relative compressibilities of the soil skeleton and the pore fluid.
- (2) hydraulic anisotropy had an appreciable effect on the response of more permeable soils but no effect on the response of soils such as silts and clays.
- (3) shear stresses were unaffected by either compressibility

or the anisotropic permeability ratio.

The findings are crucial to an understanding of the response data in wave tank studies and field tests described later.

A particularly simple analytical solution of Biot's equations is obtained for a seabed of infinite depth which is hydraulically isotropic for the very common case when the stiffness of the water is much greater than the stiffness of the sand skeleton (Yamamoto, 1978, Madsen, 1978). The attenuation of porewater pressure, p , with depth for this case is given by

$$p = p_0 e^{-\lambda z} \quad (3.8)$$

and the amplitudes of the wave-induced effective stresses are given by

$$|\sigma_x'| = |\sigma_z'| = |\tau_{xz}| = p_0 \lambda z e^{-\lambda z} \quad (3.9)$$

It is noteworthy that these equations do not contain the elastic properties of the sand skeleton, or the water, or the permeability of the sand.

(ii) Computer Program STAB-MAX.

Siddharthan and Finn (1979a) extended the Yamamoto - Madsen analyses to include the case of anisotropic permeability and finite depth of soil for layered systems. The resulting method of analysis was incorporated in the computer program STAB-MAX. The general case that can be analysed by STAB-MAX using Biot's (1941) equations is illustrated in Fig. 3.2. The program evaluates the stability of the seafloor under the wave induced effective stress system using the Mohr-Coulomb failure criterion. However, it includes the residual porewater pressure, if any, in the assessment of stability. These are ignored in the Yamamoto-Madsen stability analyses. The residual porewater pressures

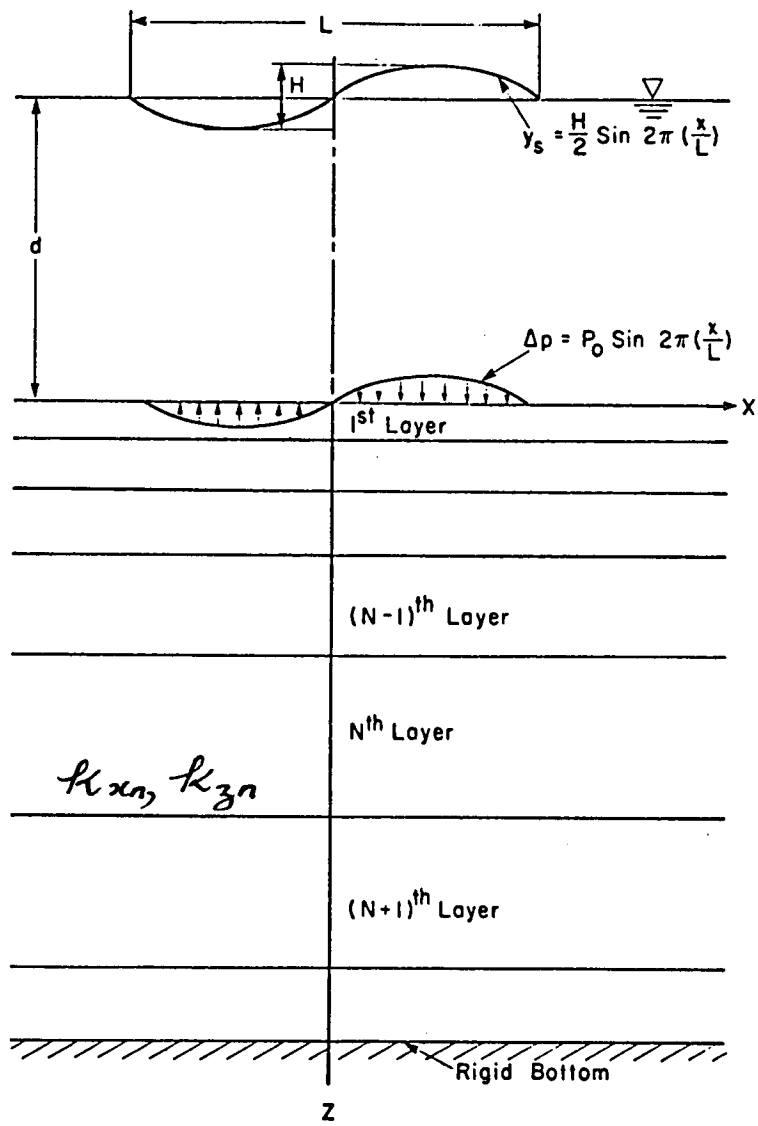

Fig. 3.2 Wave pressures on layered deposit.

affect stability only in the case of fine sands and silts as will be demonstrated in Section 3.5.

Results from a series of analyses by STAB-MAX are presented later to show the effects of anisotropic permeability in layers of finite depth, an area not covered in the Yamamoto - Madsen analyses. The results will also be used to define the range of validity of the simple approximate method of analysis presented in the next section.

Yamamoto (1983) has shown that the inclusion of Coulomb damping in the poroelastic model has no effect on the computed response of sand layers as measured by pore water pressures and increments of effective stress, although there are noticeable effects in soft clays. Yamamoto et al (1983) have also introduced an elastic non-linear stress-strain relationship. They checked the predictions using non-linear analysis against wave tank data but the results for sands did not seem to be any improvement over those obtained in other studies using linear elasticity. Non-linear analysis using an iteration procedure to ensure that moduli used in the analysis are compatible with final strains may be conducted using STAB-MAX if desired.

b) UNCOUPLED ANALYSIS OF SOIL-WATER SYSTEMS

(i) Finn-Siddharthan-Martin Method.

The analysis of soil-water systems by coupled analysis (Yamamoto, 1977, Madsen, 1978) is a complex procedure. Even the analytical solutions require a computer program for efficient evaluation except for the case of an isotropic homogeneous semi-

infinite medium with the stiffness of the soil much less than that of water and uniform permeability. It is of interest, therefore, to determine whether a simple uncoupled analysis, in which the soil and water are treated separately, may give useful results. A method for uncoupled analysis has been proposed by Finn, Siddharthan and Martin (1983) using Putnam's (1949) equation for porewater pressure and Fung's (1965) solution for the response of an elastic semi-infinite medium to harmonic waves.

(ii) Porewater Pressures Analysis.

Putnam (1949) analysed the flow in a porous bed by the pressure field specified by (3.1) and (3.2). He assumed incompressible flow, the validity of Darcy's law and hydraulic isotropy, and showed that under these conditions flow was governed by Laplace's equation. He was interested in wave damping effects and did not give an explicit expression for pore water pressures, although it was implicit in his work. Later, Liu et al., (1973) gave the following convenient expression for the amplitude of pore water pressure at depth, z , based on Putnam's solution:

$$p = p_0 \frac{\cosh \lambda(d_s - z)}{\cosh \lambda d_s} \quad (3.10)$$

in which d_s = thickness of seabed overlying a rigid impermeable layer.

For infinitely deep seafloor soils $d_s \rightarrow \infty$ and

$$p = p_0 e^{-\lambda z} \quad (3.11)$$

It is interesting to note that this equation for pore water pressure, derived on the assumption of incompressible soil and

water is identical to that in equation (8) derived from poroelastic analysis on the basis of a soil very much more compressible than water.

Sleath (1970) extended the Putnam analysis to include hydraulic anisotropy and showed that, with k_x , k_z = permeabilities in the x- and z-directions, that the amplitude of the transient porewater pressures with depth, z , could be expressed as

$$p = p_0 \frac{\cosh \left[\lambda \left(\frac{k_x}{k_z} \right)^{1/2} (d_s - z) \right]}{\cosh \left[\lambda \left(\frac{k_x}{k_z} \right)^{1/2} d_s \right]} \quad (3.12)$$

For $k_x = k_z$, this reduces to the Putnam-Liu equation (3.10). Sleath (1970) investigated the validity of (3.12) in wave tank studies discussed later in Section (3.2). Despite considerable scatter in experimental results, agreement between theory and experiment was reasonably good for the sands tested.

Moshagen and Tørum (1975) assumed the water to be compressible and the sand skeleton to be rigid. With these assumptions, the pore water pressures are governed by the heat conduction equation. Their assumptions are unrealistic and lead to excessive rates of pore water attenuation with depth, except in the case of very coarse sands as will be shown later. Therefore the Putnam-Liu equation (3.10) and the Sleath-Putnam equation (3.12) will be used to compute pore water pressures for use in uncoupled analyses.

(ii) Uncoupled Stress Analysis.

Fung (1965) has given the solutions for the amplitudes of harmonic stresses in a semi-infinite elastic medium, with harmonic wave loading on the surface, as follows:

$$\sigma_z = p_0 (e^{-\lambda z} + \lambda z e^{-\lambda z}) \quad (3.13)$$

$$\sigma_x = p_0 (e^{-\lambda z} - \lambda z e^{-\lambda z}) \quad (3.14)$$

$$\tau_{xz} = p_0 (\lambda z e^{-\lambda z}) \quad (3.15)$$

It should be noted these solutions do not contain properties of the elastic medium. When these equations are applied to a saturated sand, the resulting stresses are total stresses. If the pore water pressures, $p = p_0 e^{-\lambda z}$ (3.11), are now subtracted from the normal stress components, the resulting effective stresses are

$$\sigma_z' = -\sigma_x' = \tau_{xz} = \lambda z e^{-\lambda z} \quad (3.16)$$

exactly as given by (3.9). The important practical conclusions may, therefore, be drawn that for deep uniform deposits with fairly constant stiffness, the effective stresses may be obtained by an uncoupled analysis.

The uncoupled analysis described above has wider applicability than the simple solution of Biot's equations given by (3.8) and (3.9) because it can include anisotropic permeability. When the horizontal and vertical permeabilities are different, the pore water pressures to be subtracted from the total stresses are given by (3.12).

The stress solution given above was adapted to layered systems by Clukey, Kulhawy, and Liu (1983).

c) COMPARATIVE ANALYSES

Comparative analyses, using STAB-MAX and the uncoupled procedures described previously, were conducted on sands with a wide range in stiffness and permeability in order to check the range of validity of uncoupled analyses. The analyses also provide basic data on the effect of soil and water properties on pore water pressure and effective stress response to wave loading. This kind of background information is crucial to the exercise of engineering judgement. Four distinct types of seafloor sands were analyzed. For convenient representation on drawings they are labelled as follows, although the terminology is somewhat unconventional: HC = hard coarse; HF = hard fine, SC = soft coarse; and SF = soft fine. The physical meanings of these terms are given in Table 1. The following additional properties were assumed: Poisson Ratio = $1/3$, porosity = 0.3 ; anisotropic permeability ratios, $k_x/k_z = 1, 2$, and 5 ; density of seawater, $1,025.6 \text{ kg/m}^3$; and bulk modulus of water = $2.45 \times 10^3 \text{ n/m}^2$. It will be seen that the hard sand has a compressibility comparable to that of water. Analyses were carried out for infinite depth of seabed and a depth of 18.5 m . The depth of water was 3.67 m , and the wave characteristics were $H = 2.75 \text{ m}$, $T = 7.0 \text{ s}$, and $L = 40 \text{ m}$.

TABLE 1 - Types of Seafloor Sands

Property (1)	Sand Type			
	Hard (2)	Soft (3)	Coarse (4)	Fine (5)
G, in newtons m ⁻²	10 ⁹	5 x 10 ⁶		
k _z , in m ² s ⁻¹			10 ⁻³	10 ⁻⁶

(i) Infinite Depth, Hydraulic Isotropy.

Pore water pressures computed by the Putnam-Liu and STAB-MAX analyses are shown in Fig. 3.3. Both methods of analysis give similar results except in the case of hard fine sand. Results from the Moshagen-Tórum analysis are also shown. For hard or soft sands of low permeability, this method gives unrealistic rates of attenuation of pore water pressures with depth.

The effective normal stresses and other shear stresses, normalized with respect to the amplitude of the seafloor pressure, p_0 , are shown in Fig. 3.4 as a function of the depth ratio, z/L . For all, except hard fine sands, STAB-MAX and uncoupled analyses give similar results. For the hard fine sand, the effective horizontal and vertical stresses determined by STAB-MAX are quite different from those predicted by the uncoupled analysis. This occurs because, as may be seen from Fig. 3.3 the Putnam-Liu equation for a deep deposit is no longer applicable, i.e., $p \neq p_0 e^{-\lambda z}$ and, therefore, $|\sigma'_x| \neq |\sigma'_z|$ and they are no longer given by (3.16).

(ii) Infinite Depth, Hydraulic Anisotropy.

The effects of hydraulic anisotropy on pore water pressures and effective stresses were explored for anisotropic permeability ratios = 1, 2 and 5, and infinite depth of seafloor using STAB-MAX. The results are given in Fig. 3.5. The results are somewhat surprising. The anisotropic permeability ratio has little effect on the pore water pressure in the soft coarse or soft fine sands. A single different attenuation curve may also be used for the hard fine sand. Only for the hard coarse sand is

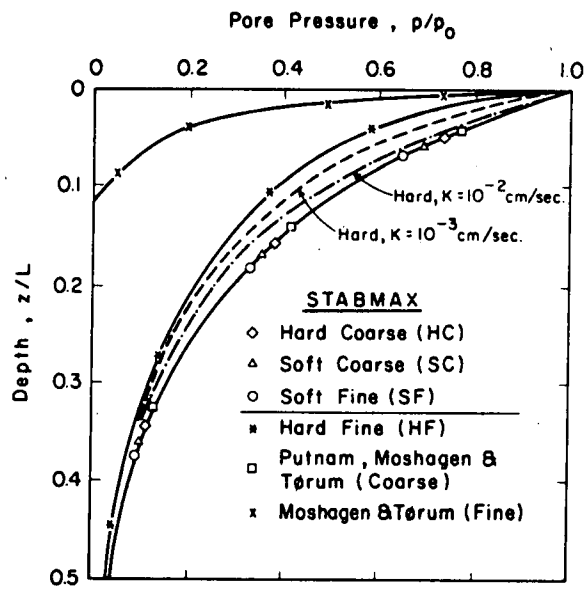

Fig. 3.3 Comparison of wave pressures by various methods.

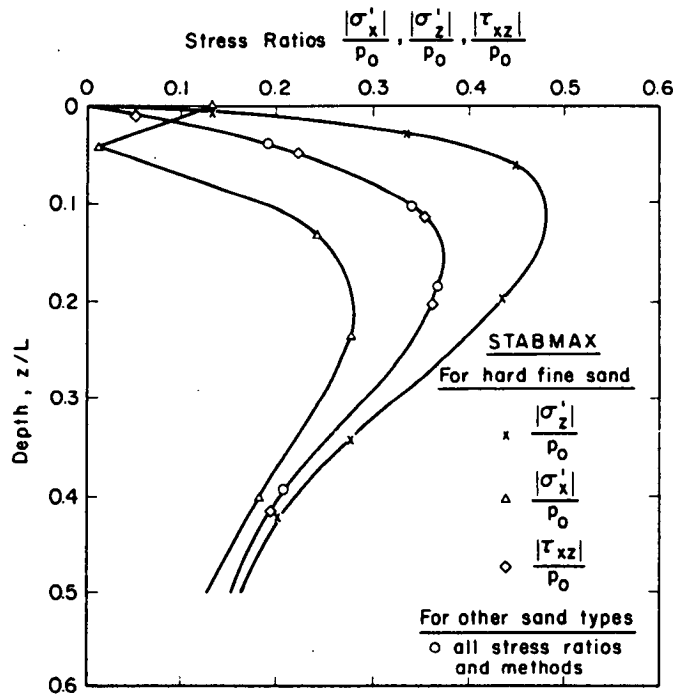

Fig. 3.4 Effective stresses by various methods.

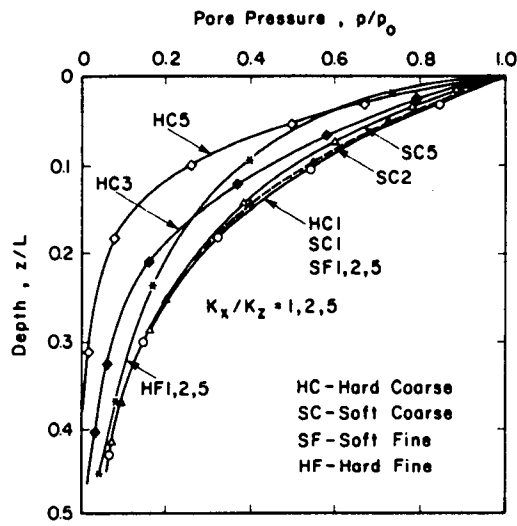

Fig. 3.5

Effect of hydraulic anisotropy on pore water pressures.

a different pore water pressure attenuation curve required for each anisotropic permeability ratio.

Uncoupled analysis may be used in cases of hydraulic anisotropy to predict pore water pressure response. The Sleath-Putnam equation (3.12) predicts accurately the pore water pressure in the hard coarse sand at all permeability ratios. The Putnam-Liu equation (3.10), although based on hydraulic isotropy, gives a good prediction of pore water pressures for the soft sands, both coarse and fine, at all permeability ratios. The shear stresses, τ_{xz} , developed in the hydraulically anisotropic deposits are shown in Fig. 3.6. For practical purposes, hydraulic anisotropy appears to have little effect on the shear stress distribution with depth.

The horizontal and vertical effective stresses appear to be quite sensitive to hydraulic anisotropy (Figs. 3.7 and 3.8). This is to be expected since the pore water pressures depend on the permeability ratio. However, if the pore water pressure is computed using the proper pore water pressure equation, and subtracted from the total normal stress elastic solution given by equations (3.13) and (3.14), effective stresses are obtained similar to those obtained by STAB-MAX for all cases except for hard fine sand.

(iii) Finite Depth, Hydraulic Isotropy.

Analytical results from analyses of seabeds of finite thickness depend very much on the ratio of thickness, d_s , to wave length, L , and it is difficult to make many useful generalizations about the response to wave loading. Results

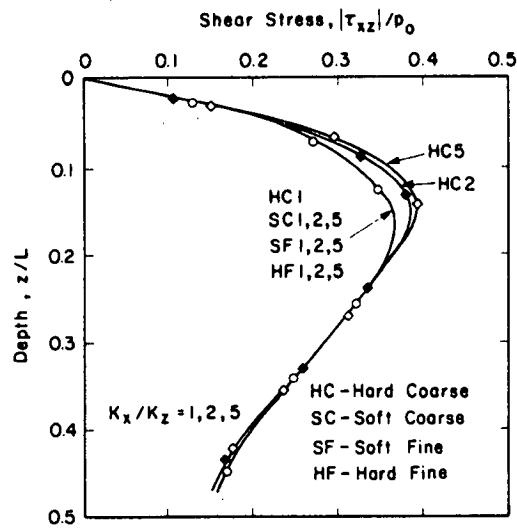

Fig. 3.6

Effect of hydraulic anisotropy on pore water pressures.

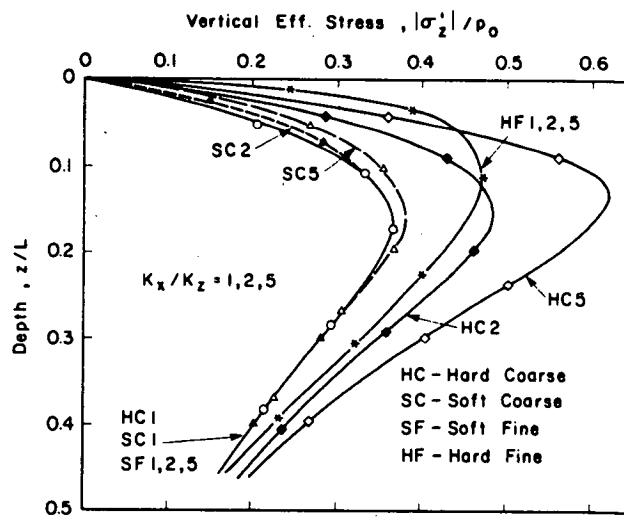

Fig. 3.7

Effect of hydraulic anisotropy on vertical effective stresses.

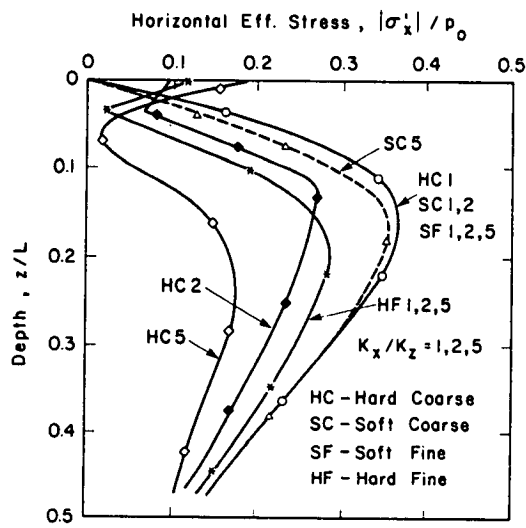

Fig. 3.8

Effect of hydraulic anisotropy on horizontal effective stresses.

shown in Figs. 3.9 and 3.10 were obtained by STAB-MAX. The depth of seabed sands was assumed to be 18.5 m. Some interesting observations can be made on the pore water pressure data in Fig. 3.9.

The attenuation curve for pore water pressure determined by the STAB-MAX program reverses curvature as the rigid impermeable base of the seabed is approached and the pore water pressures increase again. The Putnam-Liu pore water pressure curve computed using (3.10) does not have this pronounced change in curvature; it shows progressive attenuation of pore water pressure with depth. In the early part of the curve, the Putnam-Liu equation predicts pore water pressures similar to those predicted by the coupled STAB-MAX analysis for all sands except hard fine sand. The disparity between the results of the coupled and uncoupled analysis as the bottom of the seabed is approached is due to the fact that different boundary conditions are satisfied there. The pore water pressure equation must satisfy the condition of impermeability, while the coupled analysis must also satisfy displacement boundary conditions. It is apparent these conditions have quite an effect on the pore water pressures predicted by the coupled analysis.

The finite depth solution is much more dependent on the permeability than is the case for infinite depth. The shear stresses in the finite depth solution appear to be little affected by either permeability or soil properties (Fig. 3.10) as was the case for infinite depth analyses. This has important implications for analyses of residual pore water pressures which are developed almost entirely by the shear stresses. The results

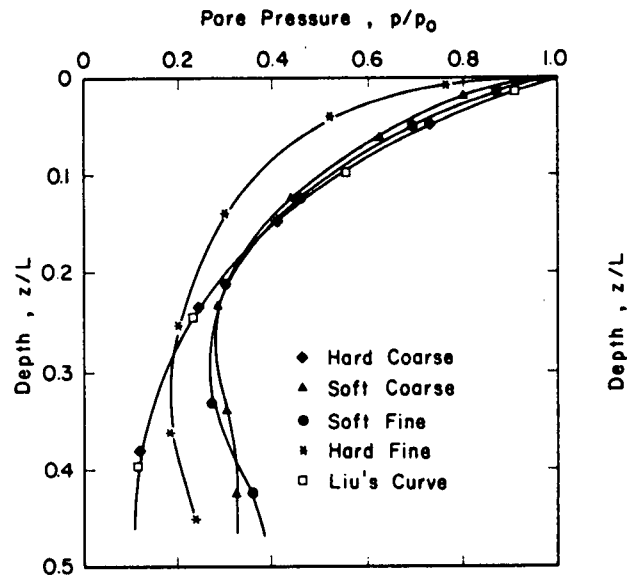

Fig. 3.9 Pore water pressures in deposit of finite depth.

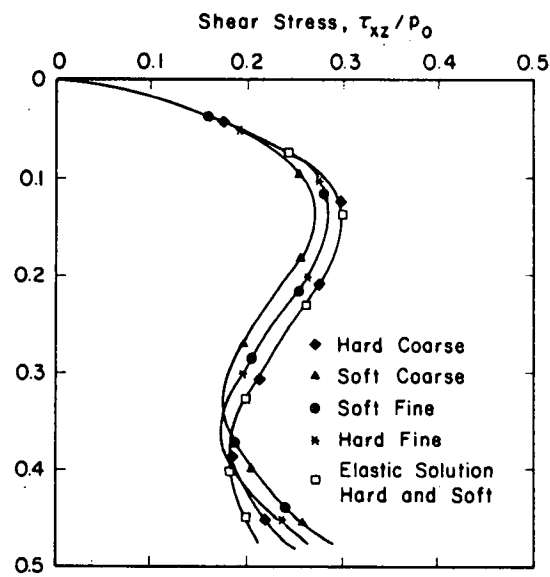

Fig. 3.10 Shear stresses in deposit of finite depth.

discussed above suggest that in many practical circumstances the wave-induced shear stresses can be determined by (3.16).

3.3 WAVE TANK DATA

a) SMALL SCALE TESTS

(i) Tests by Sleath.

Sleath (1970) measured the pore pressures in a horizontal bed of sand of constant depth under the action of monochromatic waves. The wave channel was 50 ft (15.3 m) long, 2 ft (0.6 m) wide and 3 ft (0.9 m) deep. Wave lengths ranged from 15.1 in. (0.4 m) to 452 in. (11.5 m) and wave heights from 0.7 in. (0.02 m) to 2.4 in. (0.06 m). The sand bed, 20 ft (6.2 m) long and 13 in. (0.3 m) deep was installed in the centre of the wave channel.

Tests were conducted with two grades of sand; a coarse sand with median diameter $D_{50} = 1.13$ and a sand with $D_{50} = 0.39$ mm described as fine.

Sleath's tests are very important because of the special care taken to exclude air from the sand and because they are the only tests reported where the vertical and horizontal permeability k_z and k_x were measured directly in the sand bed itself. The permeability of a sand layer is very dependent on the method of layer formation. Therefore it should be measured in situ rather than inferred from grain size distributions or measured using reconstituted samples in parameters.

The sand was deposited in thin layers from a travelling hopper under de-aired water. This method of deposition ensured very uniform properties in both the horizontal and vertical

directions. The stratification induced by the thin layers induced anisotropy in the permeability of the sand bed. The ratio k_x/k_y of the horizontal to vertical permeability was 1.4 for the coarse sand and 1.2 for the fine sand.

The experimental data on pore water pressure are presented in non-dimensional form in Figs. 3.11 and 3.12. The measured pressures p are divided by the wave pressures p_0 on the surface of the layer and plotted against the theoretical ratios computed using (3.12). If the Sleath-Putnam equation should correctly describe the pressure attenuation with depth then the experimental data would be expected to fall on a straight line between (0,0) and (1,1). The point (0,0) corresponds to a location which is a large number of wavelengths from the surface, and the point (1,1) is the surface of the bed. The theoretical pressure ratios were computed both assuming uniform permeability and using the measured permeability ratios.

There is considerable scatter in the experimental data. The unexpectedly high values near the surface of the coarse sand with $p/p_0 > 1$ were found to be due to an instrumentation problem and should be disregarded. The data cluster strongly around the theoretical lines based on the measured anisotropic permeability ratios. It is clear from a comparison with the plots based on the assumption of uniform permeability, that stratification can have a significant effect on the distribution of wave induced pore water pressures even for the very modest anisotropy ratios of the test beds.

Very low phase differences were recorded between the surface

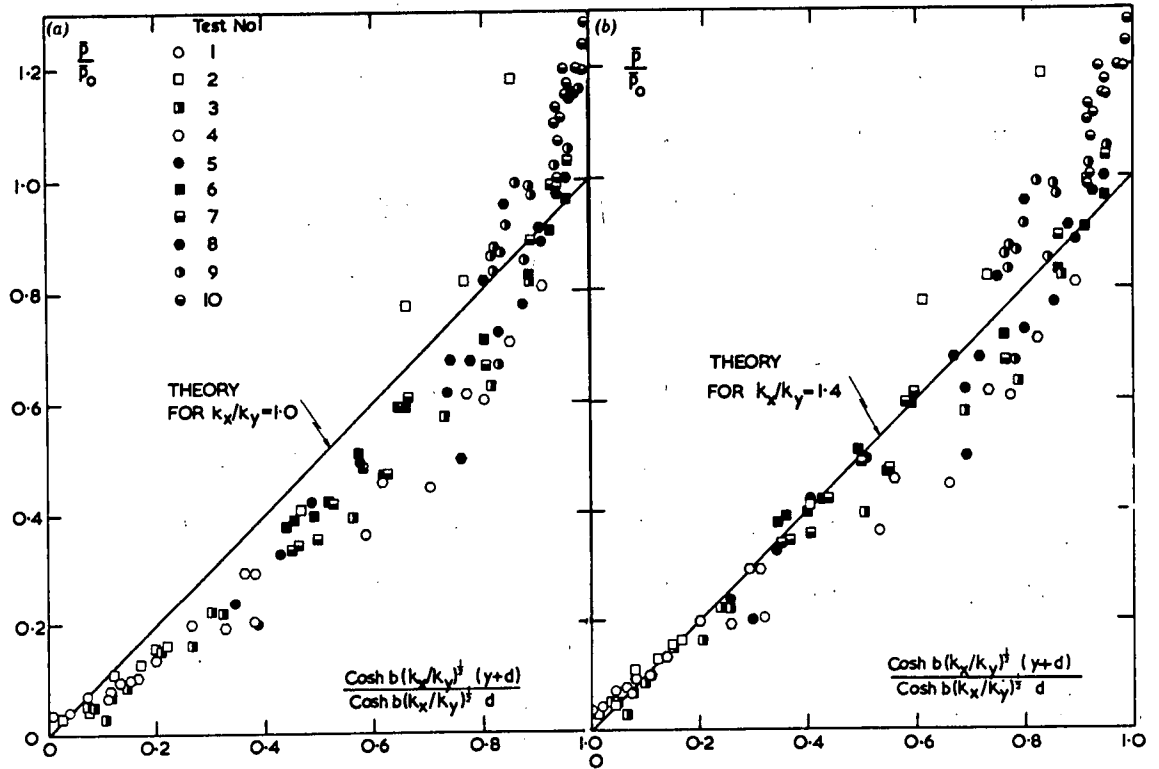

Fig. 3.11 Wave-induced pore water pressures in coarse sand.

(a) k_x/k_y ; 1.0 (b) k_x/k_y ; 1.4
 (after Sleath, 1970).

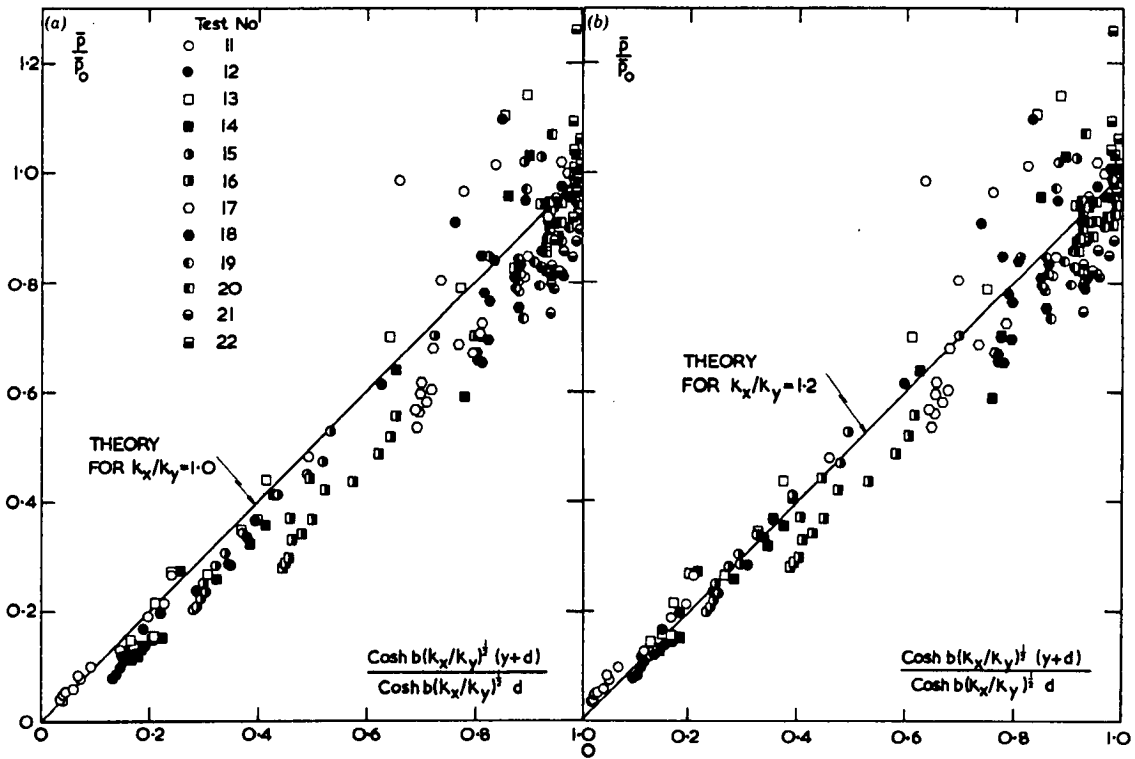

Fig. 3.12 Wave-induced pore water pressures in fine sand:
 (a) k_x/k_y ; 1.0; (b) k_x/k_y ; 1.4.
 (after Sleath, 1970).

pressure wave and the attenuated pressure waves in the sand bed. Maximum phase difference was less than 10° . If the Sleath-Putnam equation were correct, there should be no phase differences between the pressure waves.

From Sleath's tests it may be concluded that the Sleath-Putnam equation can predict wave-induced pore water pressures in sands with satisfactory accuracy if the sands are saturated and the anisotropic permeability ratios are measured in situ. The tests provide experimental confirmation of the predictions by Madsen (1978) and Siddharthan-Finn (1979) regarding the effects of anisotropic permeability.

(ii) Tests at Delft Laboratory.

Tests were conducted at the Delft Hydraulics Laboratory on coarse sand ($D_{50} = 1.2$ mm) and fine sand ($D_{50} = 0.2$ mm) beds 0.50 m thick (Yamamoto et al., 1978). The water depth was 0.9 m and wave periods ranged from $T = 1.0$ s to $T = 2.6$ s. The height and steepness of the waves were kept small to avoid sand drifting at the surface, but the wave heights were not reported. No details are given about the placement of the sand. None of the sand properties were measured.

Data from the coarse sand bed are shown by the points in Fig. 3.13; data from the fine sand in Fig. 3.14. The curves in both cases are predictions by Yamamoto's (1978) theory. However, the necessary soil properties were obtained by selecting values that gave the best fit in the least squares sense to three series of data from tests with different wavelengths. This procedure involved the assumption that the air content was about 2% and

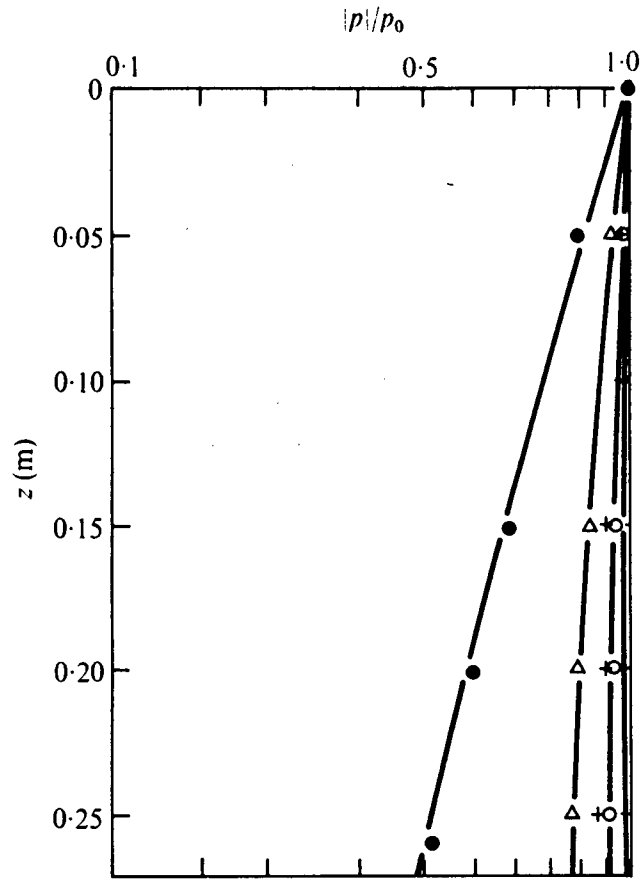

Fig. 3.13 Pore water pressure attenuation with depth in coarse sand (after Yamamoto et al., 1978).

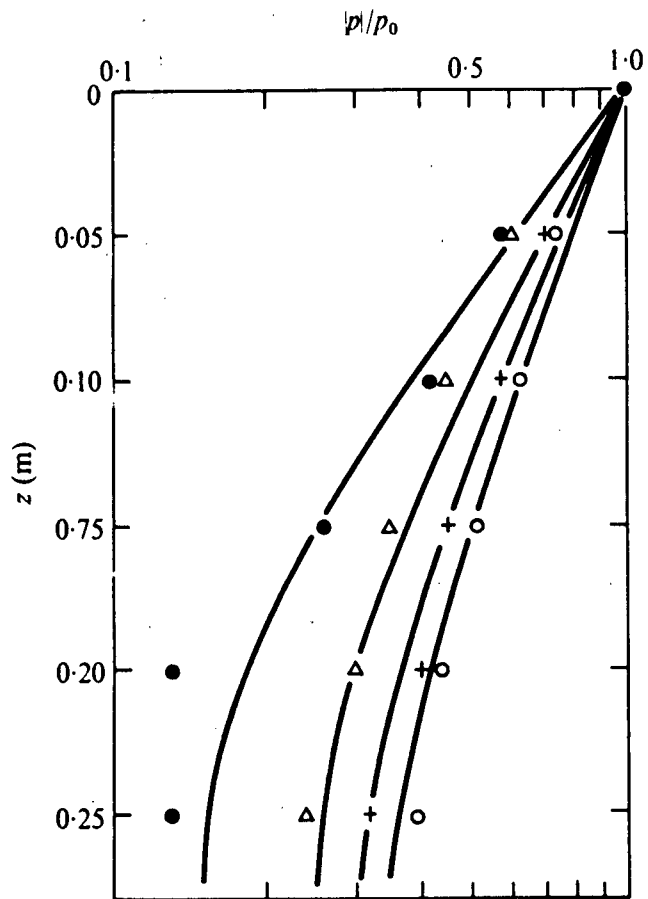

Fig. 3.14

Pore water attenuation with depth in fine sand
(after Yamamoto et al., 1978).

that the permeability was uniform. Yamamoto (1978) reports that the Putnam equation predicted pressures in the coarse sand identical with those shown by the curves in Fig. 3.13. This tends to suggest that the permeability in the coarse sand bed must have been fairly uniform.

Test data from a test series on the fine sand using waves with a period $T = 2.0s$ are shown in Fig. 3.15. Also shown are predictions by Putnam's equation for both finite and infinite depths of sand and the predictions by Yamamoto (1978) using best fit properties. It is clear that the Putnam equation greatly overestimates the pressure in this case. Since the anisotropic permeability ratio is unknown this effect cannot be taken into account. If the air content is indeed 2% however neither the Putnam nor Sleath-Putnam equations would be expected to apply.

Since no soil properties were measured in these tests the results are primarily of phenomenological interest.

(iii) Tests by Tsui and Helfrich.

Tests were conducted on a 0.33 m thick bed of sub-angular medium sand, in both a loose state at a relative density $D_r = 30\%$ and in a dense state with $D_r = 86\%$, (Tsui and Helfrich, 1983).

Data from tests with waves having a period $T = 1.5s$ and wave heights ranging from 0.02 m to 0.06 m in a water depth of 0.49 m are shown in Fig. 3.16. Theoretical pressure distributions computed using the equations of Putnam (1949) for a finite depth and that of Liu (1973) for an infinite depth are also shown. The measured pressures attenuate much more rapidly than predicted by either equation. Very large phase differences up to 120° , were

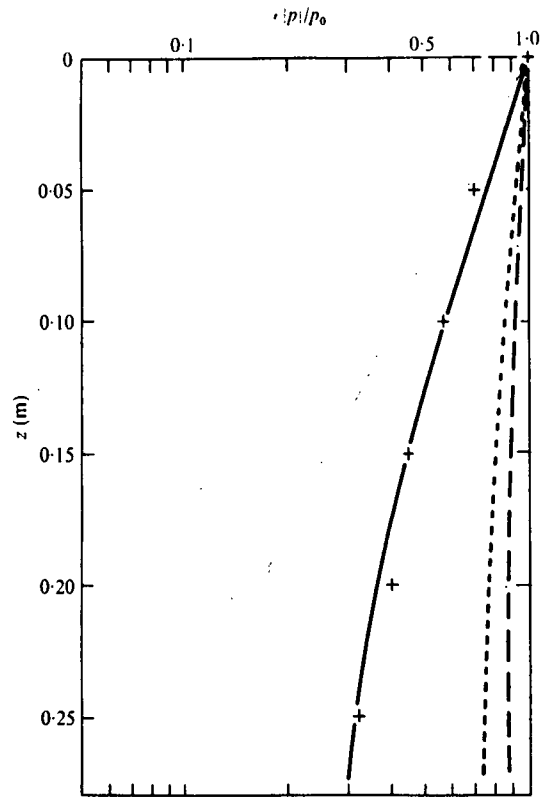

Fig. 3.15

Pore water pressure attenuation with depth in fine sand. Comparison of data with Yamamoto (1978) and Putnam (1949). (adapted from Yamamoto et al., 1978).

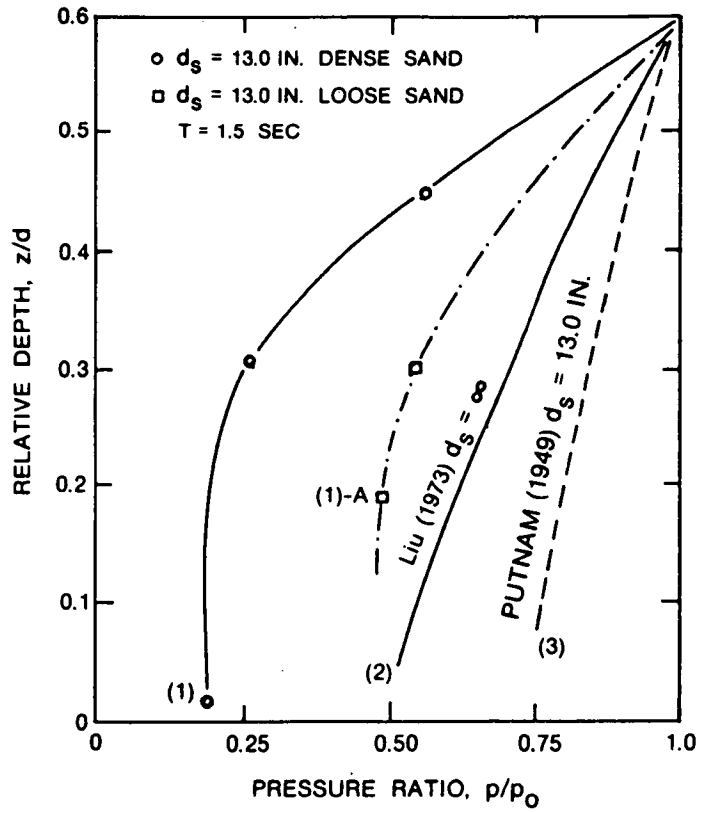

Fig. 3.16 Comparison of measured and theoretical attenuation of pore water pressure (after Tsui and Helfrick, 1983).

recorded which suggests the inapplicability of the equations, both of which show zero phase difference.

The dense sand was placed dry and compacted to the required density before the tank was filled with water. It is highly likely that air was trapped in the bed resulting in dramatic increases in the compressibility of the pore fluid. As shown by Madsen (1978) increased compressibility in the pore fluid results in a much sharper attenuation of the pressure wave. The method of placement probably resulted in anisotropic permeability in the sand which would further attenuate the pressure wave. However the anisotropic permeability ratio was not measured.

(iv) Tests at Cornell University

A very comprehensive series of tests were conducted on sand and silt beds at Cornell University (Clukey, Kulhaway and Liu, 1983) to evaluate the effective stress response of the sediments to wave loading and to compare the measured response with Yamamoto's (1978) analytical solution. The tests were conducted in a wave tank 17.1 m long, 0.76 m wide and 0.91 m deep in the main section: the sediment bay, located in the centre section, was 4.6 m long and 0.85 m deep. The top of the sediment was flush with the floors of the other sections of the tank. Glass walls along the sides of the tank permitted observation of the response of most of the upper 0.5 m of sediment during the tests.

Wave periods ranged from $T = 1.28\text{s}$ to $T = 2.58\text{s}$ and wave heights from $H = 0.7\text{ m}$ to $H = 0.25\text{ m}$. These heights approached the breaking heights in the various experiments.

Sand Tests: The sand was deposited by pluviation through water from a moving sediment carriage. For some tests the sand

was compacted by dropping a compactor on the surface of successive 0.12 m layers. Pore water pressures and total stresses were measured during the tests. However, because of electronic problems only one total stress measurement could be made per test. To get broader coverage of the total stress distribution, results from the single cell from different test runs in a given frequency range were normalized with respect to the pore water pressure at the mudline. This introduces an element of uncertainty into the total stress distribution.

The parameters needed to apply Yamamoto's (1978) theory include Poisson's ratio ν , the coefficient of permeability k , the coefficient of consolidation C_v , either the shear modulus G or Young's modulus E , unit weight of soil, and the bulk modulus of the pore fluid. For the sand, it was assumed that $\nu = 0.33$. The coefficient of permeability was estimated from the grain-size distribution and was not measured directly. The shear modulus was measured in two simple shear tests at appropriately low confining pressures. However it is notoriously difficult to measure moduli of sand reliably in conventional test equipment at low confining stresses and it is likely that the shear modulus was underestimated.

Considerable effort was devoted to determination of the degree of saturation of the sand bed. It was finally estimated to be $S = 95\%$, so the effective bulk modulus of the pore fluid was taken to be 2.0 MN/m^2 .

Results of Sand Tests: Typical data on the attenuation of pore water pressures are illustrated in Fig. 3.17 and Fig. 3.18.

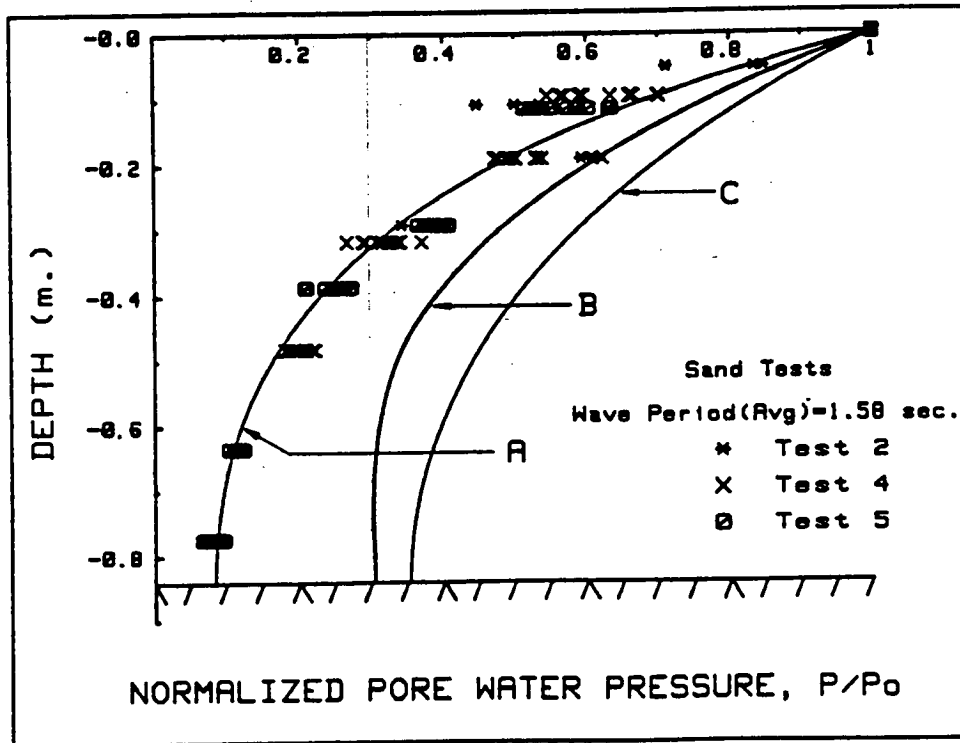

Fig. 3.17 Comparison of measured and theoretical attenuations of pore water pressure.

A= best fit to data, B= Yamamoto, 1978 and
C= Putnam-Liu-Sleath (after Clukey et al., 1983).

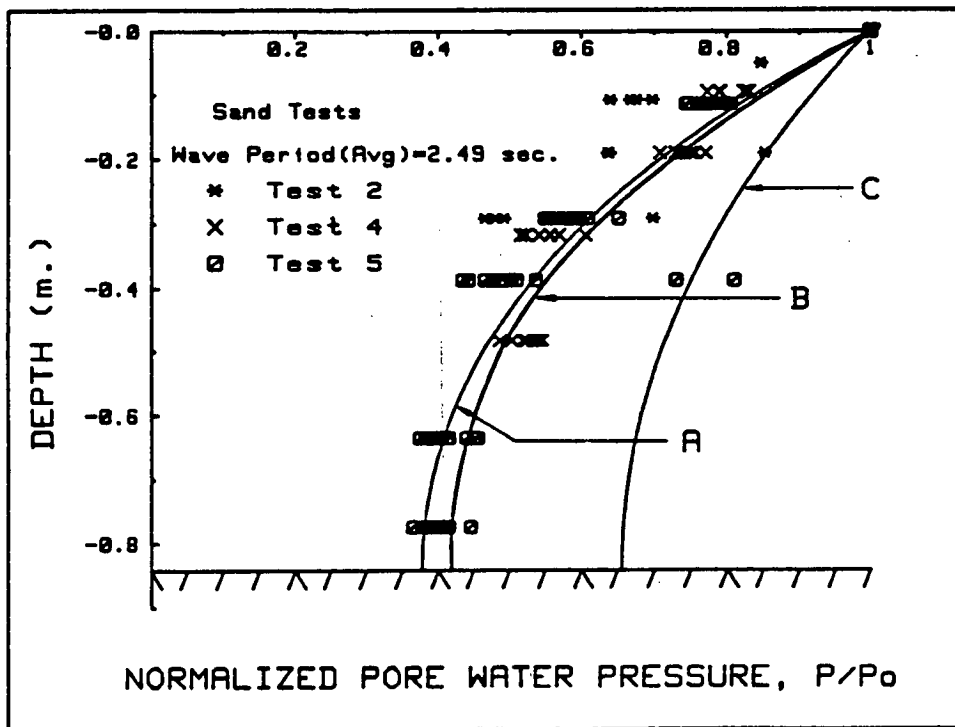

Fig. 3.18

Comparison of measured and theoretical attenuations of pore water pressure A= best fit to data, B= Yamamoto, 1978, C= Putnam-Liu-Sleath.

Curve A is the best fit to the data in the least squares sense in each figure. Yamamoto's (1978) solution is shown by curve B and predictions by Putnam's equation are shown by curve C. In all tests the measured pore water pressures were considerably less than those predicted by either the Putnam or Yamamoto solutions. Only in one instance when the wave period was $T = 2.49s$ were the predictions by Yamamoto (1978) close to the measured values.

With a saturation level of only 95% the Putnam equation is clearly not applicable. The anisotropic permeability ratio was not measured. The method of placement was somewhat similar to that used by Sleath (1970) so it is probable that some anisotropy developed which could attenuate the pressure wave more rapidly. The Yamamoto (1978) solution which takes the degree of saturation into account gives a much better prediction than the Putnam equation but except for the case when $T = 2.49s$ the rate of attenuation is still significantly underestimated. Solutions by STAB-MAX (Siddharthan and Finn 1979a) which takes finite depth and the anisotropic permeability ratio into account would lead to better predictions than curve B if significant anisotropy were present.

The Yamamoto (1978) predictions may also be affected by differences between the mechanical properties of the sand in the bed and the sand in the reconstituted samples used in the simple shear tests. And, as pointed out earlier, the measured shear moduli are probably too low.

One of the unique and more interesting facets of these tests is the experimental determination of the effective vertical and horizontal stresses. As mentioned earlier, because of electrical

problems, only one total stress cell could be used per test run. Therefore the distribution of total stresses had to be built up by combining data from different tests. This introduces variations in conditions that lead to further scatter in the data.

Test data on effective vertical stresses are shown in Fig. 3.19a and Fig. 3.19b. The distribution of the data points is rather random. The vertical stresses were much higher near the mud-line than the Yamamoto analysis (1978) predicted and attenuated much faster with depth. These properties of effective vertical stress distribution may be noted in the STAB-MAX analysis for anisotropic permeabilities in Fig. 3.7. These characteristics are associated with the hard coarse and hard fine sands. These sands had compressibilities comparable to that of the pore water as was the case in the Cornell tests. In the case of the STAB-MAX analyses, the comparability in compressibilities arose because a very stiff sand skeleton was selected for analysis, in the Cornell tests the comparability arose because of air in the pore fluid. However Madsen (1978) points out that it is the relative compressibility rather than the absolute values that affect the pore water pressures and effective stresses. An analysis of the Cornell data by STAB-MAX using an anisotropic permeability ratio of about 2 might lead to a better match of the general trends in the data.

The data on effective horizontal stresses (Fig. 3.20) show more consistent trends than the data on vertical stresses but are in general substantially lower than predicted by the Yamamoto

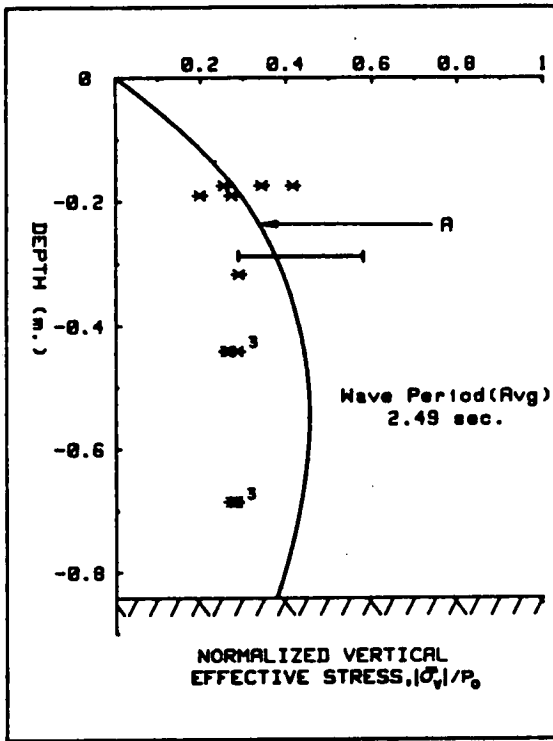

(a)

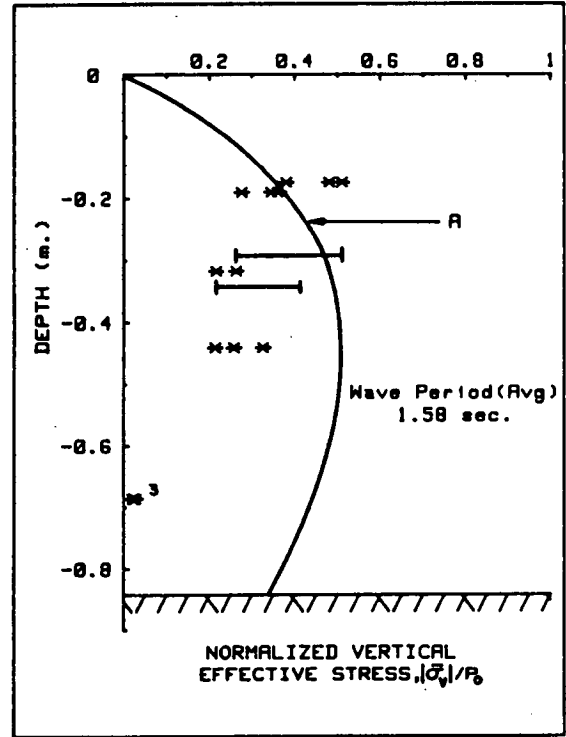

(b)

Fig. 3.19 Comparison of effective vertical stress data with Yamamoto (1978), curves A. (after Clukey et al., 1983).

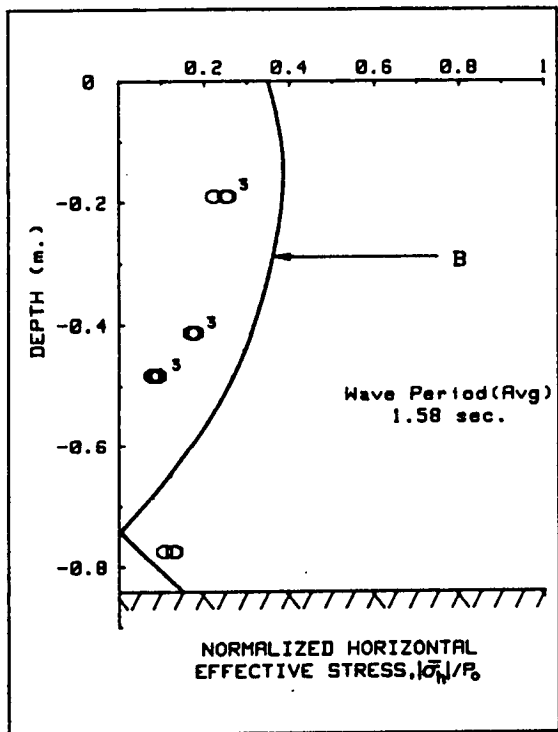

(a)

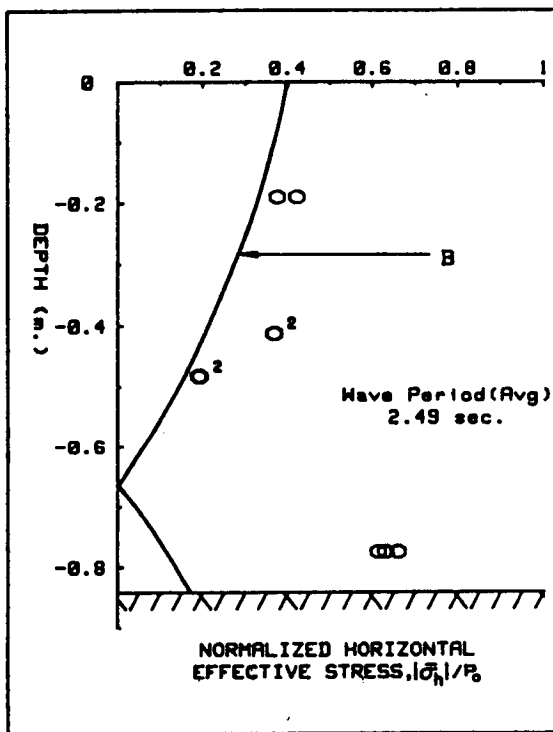

(b)

Fig. 3.20 Comparison of effective horizontal stress data with Yamamoto (1978), curves B (after Clukey et al., 1983).

(1978) analysis. The smaller than theoretical stresses may result from anisotropic permeability. Increased permeability in the horizontal direction would lead to a reduction in horizontal effective stresses.

The permeability of the Cornell test sand bed was about $k = 1.15 \times 10^{-3}$ m/s comparable to the coarse sand used in the STAB-MAX analyses. Again confining attention to the hard sand, with compressibility comparable to that of the pore water, the marked reduction in horizontal effective stress for a permeability ratio of 2 or more from the case of uniform permeability may be seen in Fig. 3.8.

The data from the STAB-MAX analyses presented in Figs. 3.7 and 3.8 show the important influence of anisotropic permeability on predictions of vertical and horizontal effective stresses due to wave loading, especially when the compressibilities of the soil skeleton and the pore fluid are comparable.

b) LARGE SCALE TESTS

(i) Tests at Oregon State University.

Tests conducted at Oregon State University have been reported by McDougall et al. (1983). The wave tank was 104.3 m long, 4.6 m deep and has an 11 m long sediment section located in the centre. The best section consisted of a 0.3 m gravel layer overlying a 9.91 m sand layer. The sand was placed by pluviation and was subsequently fluidised by a high pressure water jet to remove entrapped air. The test program was conducted to determine the effects of various geotextiles placed between the gravel and the sand layers. Some tests which were conducted

without geotextiles are described here.

The sand had an average porosity of 44% and a permeability of 7.9×10^{-3} cm/s. The water depth in these tests was 2.44 m. Data and theoretical curves for two series of tests are shown in Fig. 3.21. The dashed line is the prediction by Yamamoto's (1977, 1978) theory for 100% saturation. The measured attenuation of pore water pressure is much greater than the theoretical prediction.

The discrepancy between theory and data may be due to saturation less than 100% and the anisotropic permeability ratio. Both would increase the rate of pressure attenuation with depth. However neither of these were measured during the test program. McDougall et al. (1983) suggested that the no slip condition implied at the bottom boundary in Yamamoto's (1977) analysis may not be appropriate. Attenuation was increased when such slip was allowed, as shown by the full curves in Fig. 3.21. However there was no experimental evidence that slip occurred.

It may be noted that the curves shown in Fig. 3.21 all start from the top of the sand layer. It is not clear from available data whether the sand layer was treated as an independent layer during the analysis or whether the gravel layer was included. If the sand layer were treated independently the boundary conditions at the surface would be in error because the proper conditions of stress and deformation resulting from the gravel layer would be unknown.

(ii) Tests at Delft Laboratory.

Tests at Delft Laboratory were reported by Lindenburg et al.

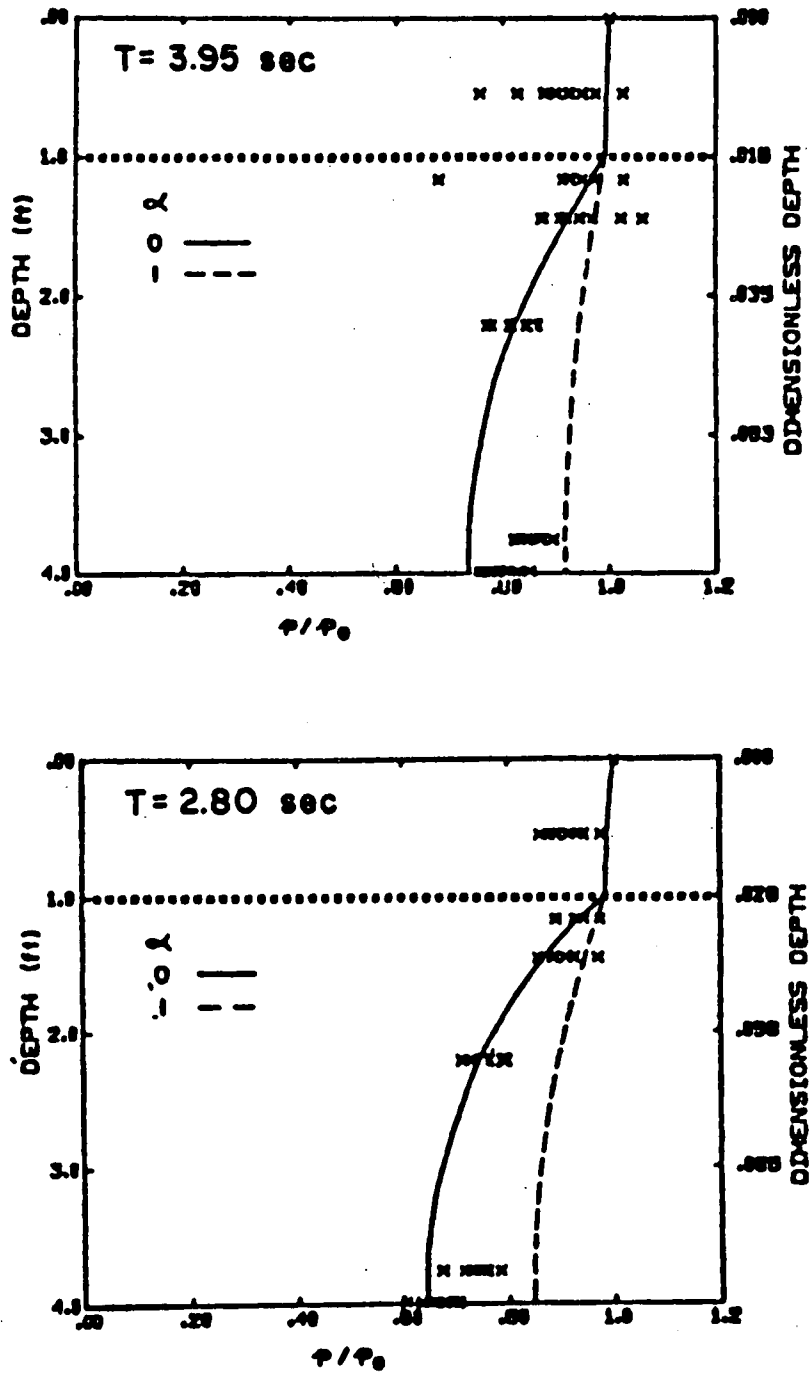

Fig. 3.21

Comparison of measured and experimental water pressures $\alpha=1$, Yamamoto, 1978; $\alpha=0$ modified Yamamoto (1978).

(1982) which were part of a study of wave-induced pore water pressures under a caisson. Pore water pressures were also measured in the free field away from the caisson. The Delft wave tank is 240 m long, and 7 m deep in the central sediment section.

Free field measurements were made in a fine sand layer ($D_{50} = 0.15$ mm) 2.5 m thick below the antinode of a 5s standing wave. The compressibility of the pore water and therefore the degree of saturation of the sand were checked by tests on samples of the bed and by measuring seismic velocity of pressure waves in situ. The tests indicated a degree of saturation of about $S = 99.4\%$.

The pressure attenuation was computed by Yamamoto's (1978) analysis. It is not clear whether the Yamamoto analysis was carried out using $S = 99.4\%$ or not. The conclusions from comparing the data with the predictions of the Yamamoto analysis are stated obliquely: the measured data are within 87% of the predictions by the Yamamoto analysis assuming $S = 100\%$.

c) CONCLUSIONS FROM WAVE TANK STUDIES.

Two of the more important parameters controlling the development of wave-induced transient pore water pressures and vertical and horizontal effective stresses in sands, are the air content of the pore water and the anisotropic permeability ratio of the sand formations. In Sleath's (1970) tests in which special care was taken to exclude air and the anisotropic permeability ratio was measured in situ and taken into account in the analysis, the theoretical predictions of pore water pressures using the Sleath-Putnam equation (3.12) are very good.

In all the other tests discussed earlier the anisotropic

permeability ratio was not measured in situ or estimated on any other basis. All the tests contained some air, in some cases as much as 5% by volume. It is very difficult to measure air content accurately. In most of the tests the comparison between Yamamoto's analysis and the test data was not good when measured soil properties were used. The theory does not make provision for anisotropic permeability and even if it had, it was not measured in the tests. Errors in estimating the air content also influences the quality of the predictions. In most cases the infinite depth solution was used although clearly finite depth analyses would have been more appropriate. Finally, the Yamamoto analysis requires the shear modulus and other theoretical properties of the soil. In some cases these values were assumed or selected to give a good least squares fit to data; in a few cases they were measured. In this connection it is worth repeating how difficult it is to measure the mechanical properties of sand adequately at the low confining pressures existing in the wave tank studies.

The tests by Clukey, Kulhaway and Liu (1983) were conducted with great care, had modern electronic instrumentation and sophisticated data processing. In spite of these advantages, a very important lesson to be learned from these tests is how difficult it is to get consistent, reliable data on wave-sediment interaction from wave-tank studies. The low stress levels induced by the test waves make reliable stress measurements near the surface of the test formations difficult to obtain.

Despite the disparity between theory and data from many of

the wave tank studies, it does seem that a poroelastic analysis based on Biot's (1941) equations could be very useful in predicting the response to wave loading. An improved correlation between data and theory requires a knowledge of the air content and anisotropic permeability in situ and a reliable estimate of the mechanical properties of the soils. To incorporate all this data requires the capability to conduct analyses of layered soils of finite depth with anisotropic permeability ratios. At present such analyses can be conducted using STAB-MAX (Siddharthan and Finn, 1979). It may also be useful as suggested by Yamamoto, Takahishi and Schuckman (1983) to include non-linear elasticity and Coulomb's damping.

The simple uncoupled analysis proposed by Finn, Siddharthan and Martin (1983) should apply in many practical situations. It includes the effects of anisotropic permeability. Although the pore water pressure equation does not apply when there is air in the voids this may not be much of a handicap in the offshore environment as distinct from wave tank studies. The effect of included air offshore will be much less than in tank studies because the absolute pore water pressure P_0 offshore will be much greater and hence the effects of the term $(1-S)/P_0$ on the effective bulk modulus will be much less. In wave tank studies P_0 is little more than atmospheric whereas in 30 m of water $P_0 \approx 3$ atmospheres. At this absolute pressure the effective bulk modulus is of the order of 10^7 kN/m² whereas in the tank studies it was of the order of 10^6 kN/m². The different relative effects of degrees of saturation in model tests and offshore should be kept in mind when using model data to explain field performance.

3.4 FIELD DATA ON TRANSIENT PRESSURES

The dangers posed by wave induced instability of the seafloor to offshore pipelines and structures is well recognized, and in recent years a number of field monitoring programs have been instituted to measure wave induced pore water pressures in the seafloor. Pressures have been recorded at substantial depths in the seafloor (>5 m) in the Gulf of Mexico and at Pacifica, California. The Gulf experiments were part of the Shallow Experiment to Assess Storm Wave Effects on the Bottom (SEASWAB); the Pacifica tests were part of the Southwest Ocean Outfall Project (SWOOP). Pore water pressures have been measured at shallow depths (<2 m) at Shimizu Harbour, Japan and also at Pacifica by the United States Geological Survey (USGS).

a) SWOOP TESTS AT PACIFICA.

A Wastewater Management Master Plan of the City and County of San Francisco, California, for collecting, treating and disposing of both sanitary and storm wastewater flows, directed that these flows were to be dispersed through an ocean outfall in the Pacific Ocean. The outfall, throughout most of its length of approximately 4,000 ft (1,220 m), was to be buried in a trench excavated as much as 7.5 m below the existing seafloor. The attenuation of wave induced pore water pressure below the seafloor, which is required in the planning of offshore tunneling operations and in the computation of forces on the buried pipeline, was measured in the field by Cross et al., (1979). The soil materials encountered were predominantly loose fine sands

near the seafloor, medium dense below 0.6 m, and dense to very dense below 2.5 m.

The wave induced pore water pressures were measured using a vertical piezometer array installed from a municipal pier in Pacifica, California, located approximately 600 ft (183 m) from shore in 16 ft (5 m) of water. The piezometers, which were of the IRAD vibrating wire type, were placed at 9, 18, 26 and 37 m below the seafloor. At these depths the residual pore water pressures in the dense sands are negligible, and recorded pore water pressures are primarily of the instantaneous transient type.

In the STAB-MAX analyses, typical average soil properties were assigned to the various soil types (Fig. 3.22) identified by Cross et al., (1979). In particular, an anisotropic permeability ratio, $k_x/k_z = 2$, was used and values of the vertical permeability, k_z , were selected on the basis of particle size distribution data.

The recorded pore water pressures, p , expressed as the ratios $p/2\gamma_w H$, are shown in Fig. 3.23 by the plotted points, in which γ_w = the unit weight of water, and H = the wave height. Data are given for two different wave patterns. The pore water pressures predicted by STAB-MAX are shown by the curves. The predictions for a wave height of $H = 9.5$ ft (3 m) are very good, and are also good for $H = 5$ ft (1.5 m), except at the upper piezometer at the depth of 30 ft (9 m). The agreement between pore water pressures recorded under field conditions and those predicted by STAB-MAX is very encouraging.

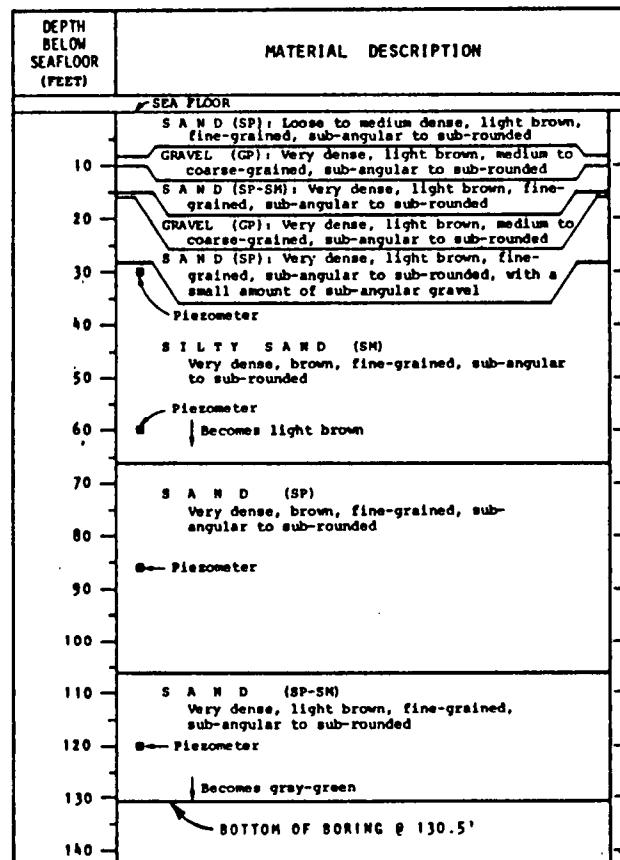

Fig. 3.22

Core log at site of SWOOP experiments (after Cross et al., 1979).

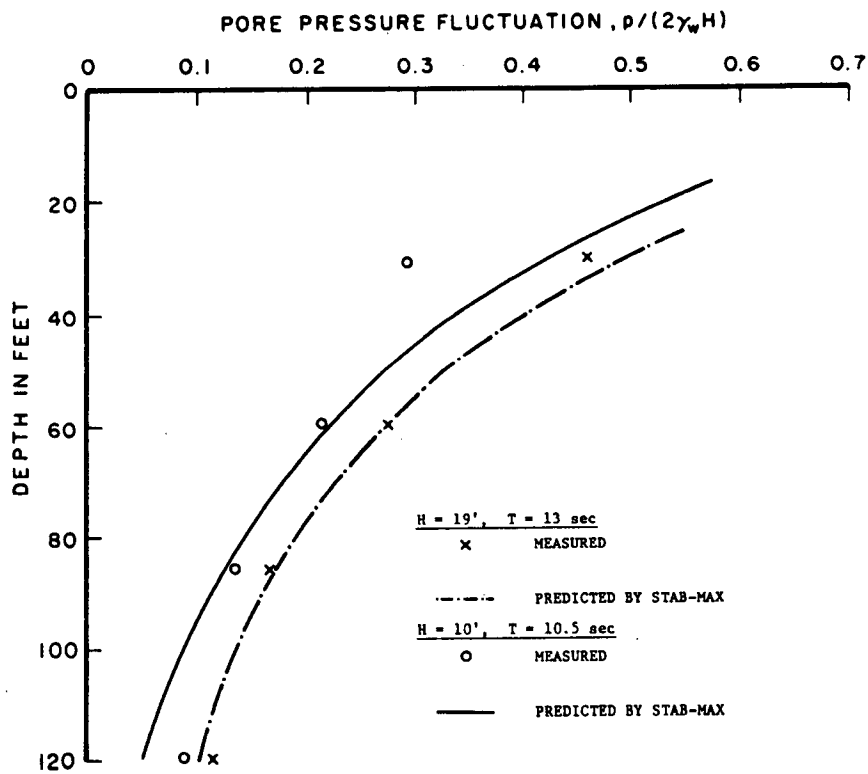

Fig. 3.23

Comparison of measured and predicted pore water pressures using STAB-MAX.

b) USGS TESTS AT PACIFICA.

Pore water pressures were measured at a depth of 0.5 m into the seafloor at Pacifica by Clukey, Kulhawy and Liu (1983). The site is the same as that used by Cross et al., (1979). In this case the water depth was 2.5 to 3.0 m. The sediment was a fine-grained sand. A schematic drawing of the test set-up is shown in Fig. 3.24, and some typical output showing the variations in differential pressures between the seafloor and a depth of 0.5 m are shown in Fig. 3.25. The recorded data suggested that the pore water pressure was increasing with depth rather than being attenuated as predicted by any of the theoretical methods discussed so far.

The pore water pressure probe at Pacifica was emplaced after large waves were first observed. It is likely that some residual pore water pressures were created before the probe was installed. However over the four subsequent hours during which records were taken, no cumulative increase in pore water pressure was noticed. It is possible that the residual pore water pressures had stabilized before the probe was inserted.

c) SHIMIZU HARBOUR TESTS.

Okusa and Uchida (1980) describe pore water pressure measurements in the shallow sediments of Shimizu Harbour. The bottom sediments at the site consist of 8 m of alluvial silty sand, and sandy silt over Pleistocene hard silty clay and sandy silt beds. The pore water pressure probe measured the pressure differences between the seafloor and at a depth of 1.5 m in the

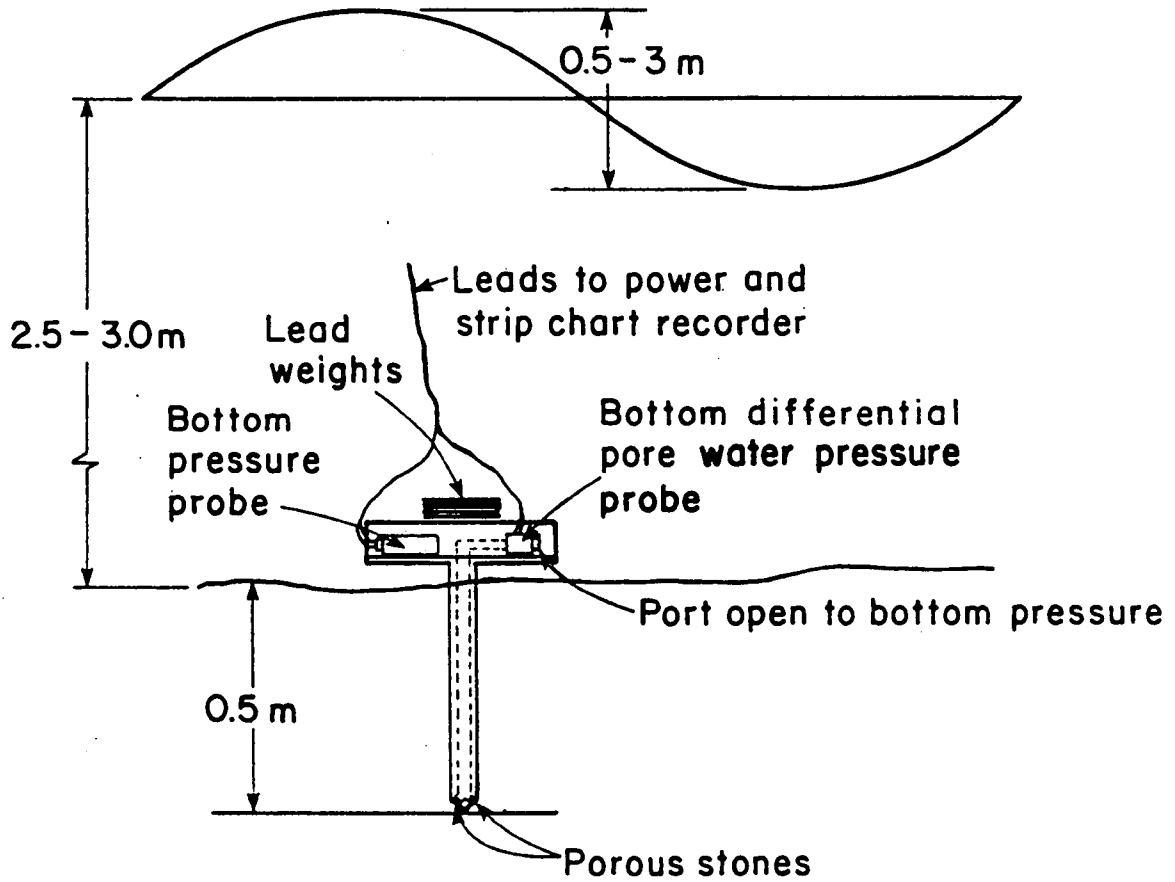

Fig. 3.24 Schematic drawing of shallow experiment at Pacifica, California (after Clukey et al., 1983).

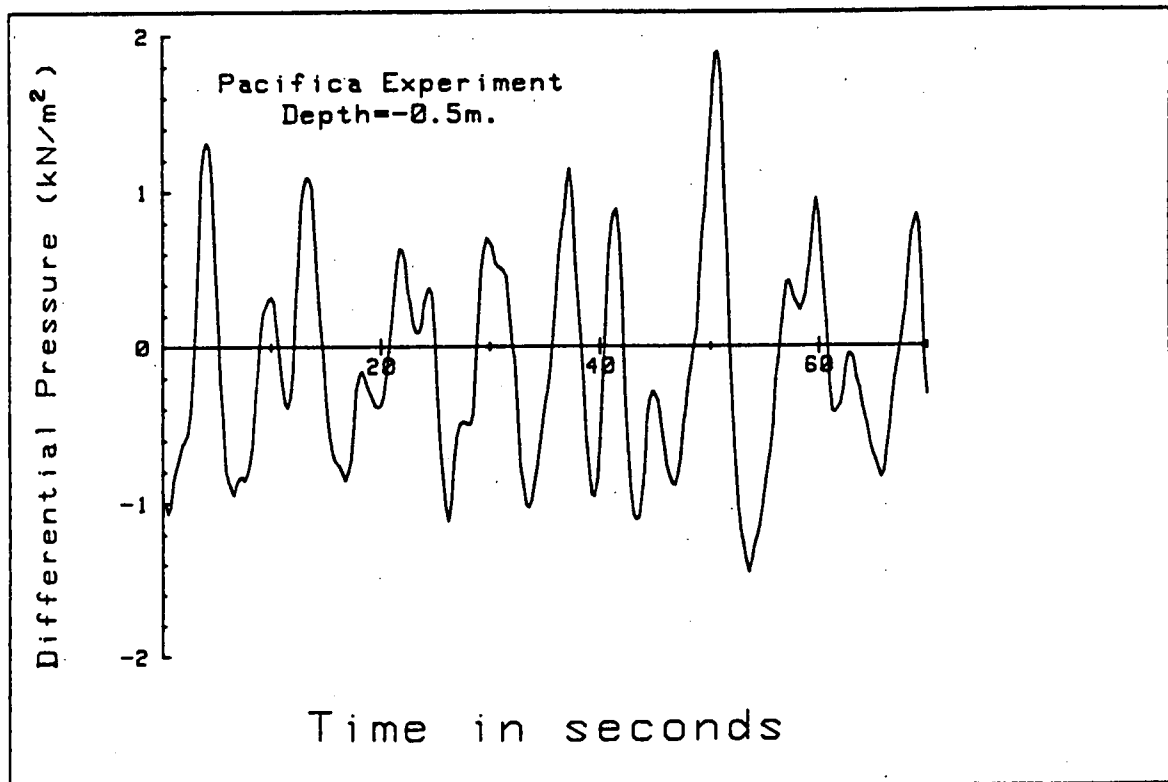

Fig. 3.25

Digitized record from shallow Pacifica Experiment (after Clukey et al., 1983).

sediments during the passage of waves. The water depth was 12 m. The surface wave pressure in the sea was measured at a location of 10 m above the seafloor, and the water pressure on the seafloor was computed from the measured value at the probe for each wave period using linear wave theory.

A typical pore water pressure record is shown in Fig. 3.26. There is a phase difference between the pressures at the seafloor and those at a depth of 1.5 m. It is evident that during the initial large waves, some residual pore water pressure began to accumulate (strong drift of the record in one direction) but as the wave amplitude dropped these clearly drained away, leaving only the transient pore water pressures on the record. Results from measurements taken during the readings show a damping or attenuation of the pressure wave in the sediment. (Table 2, col. 4). The attenuation increases with decreasing period as would be predicted by all theories discussed herein.

d) SEASWAB TESTS IN GULF OF MEXICO.

The SEASWAB experiments were a joint effort between the National Oceanographic and Atmospheric Administration (NOAA), Lehigh University, Texas A and M University and the U.S. Geological Survey. Instruments for measuring pore water pressure were placed by NOAA and Lehigh in 1977 (Hirst and Richards, 1977) for the first set of experiments.

The site of SEASWAB I was located in South Pass Block 28 off the delta. The sediment is a highly elastic clay with a water content near the liquid limit.

Shortly after the probes were installed Hurricane Eloise

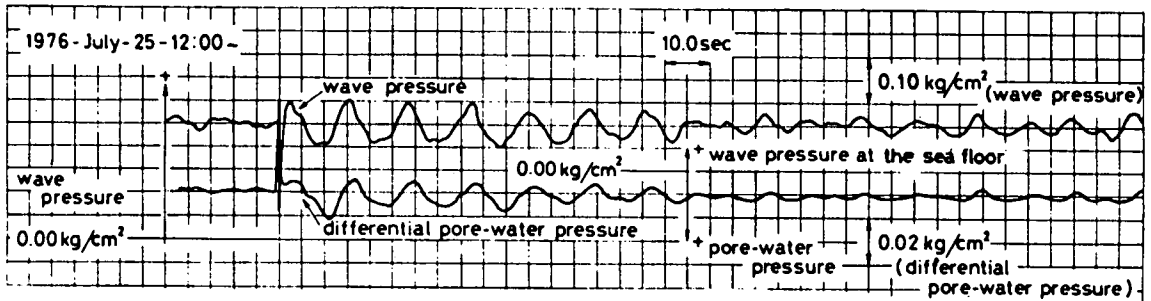

Fig. 3.26 Waveforms of differential pore water pressure and surface pressure (after Okusa and Uchida, 1980).

Table 2 - Fluctuations of maximum wave and differential pore-water pressures for different wave periods, and damping of pore-water pressure.

Date	Approximate wave period (s)	Wave pressure at about 10 m from sea floor $p(t)/\gamma_w$ (cm)	Calculated wave pressure at sea floor $p(t) \times k/\gamma_w$ $= u(t)/\gamma_w$ (cm)	Fluctuation of differential pore-water pressure $\Delta u/\gamma_w$ (cm)	Damping ratio $\xi = 1 + \Delta u/u(t)$
23.00-23.05 11-11-77	4	65	10.0	- 5.0	0.5
13.00-13.05 12-11-77	6	86	45.2	-11.0	0.76
13.00-13.05 12-11-77	7	87	56.4	-10.0	0.82
01.00-01.05 13-11-77	8	73	53.3	- 8.4	0.84
12.00-12.05 25-07-76	10	90	74.5	-11.6	0.85
12.00-12.05 25-07-76	12	100	88.0	-17.8	0.80
12.00-12.05 25-07-76	13	73	65.3	-10.4	0.84

occurred and generated waves 1.5 m high at the site. Wave length and wave period data were not reported for Hurricane Eloise. Using measured pressure data from the water column, the wave number λ and the base pressure p_0 were determined using (3.10) which describes attenuation in the water column for deep water as well as the pore water pressures in the seafloor. Knowing λ and p_0 the pore water pressure curve in the sediment was computed using (10). The results are plotted in Fig. 3.27. The recorded pressure data is also shown. Clearly the recorded pressures attenuate much more rapidly than theory predicts.

In this case the discrepancy between theory and measured data cannot be attributed to anisotropic permeability of the seabed. The anisotropic permeability ratio has no effect on the pore water pressure in soils of the category silt or finer. (Madsen, 1978; Finn, Siddharthan and Martin, 1982). The differences are probably due to gas in the pore fluid. All of the SEASWAB data are affected by gas-charging. Time lags in the records from the sediment in relation to the surface waves are attributed to different amounts of methane in the sediments.

A second set of experiments, SEASWAB II, were conducted about 1800 m from the site of SEASWAB I (Dunlap et al., 1978). The water was shallower and consequently the impact of surface waves on the bottom was greater. The maximum wave height encountered in the tests was 3.0 m (Williams, Dunlap and Hansen, 1981). The recorded pore water pressures oscillated around the mean value in the early part of the storm but about 40 hours after large waves began at the site, the mean pore water pressure increased substantially. This rather sudden increase was

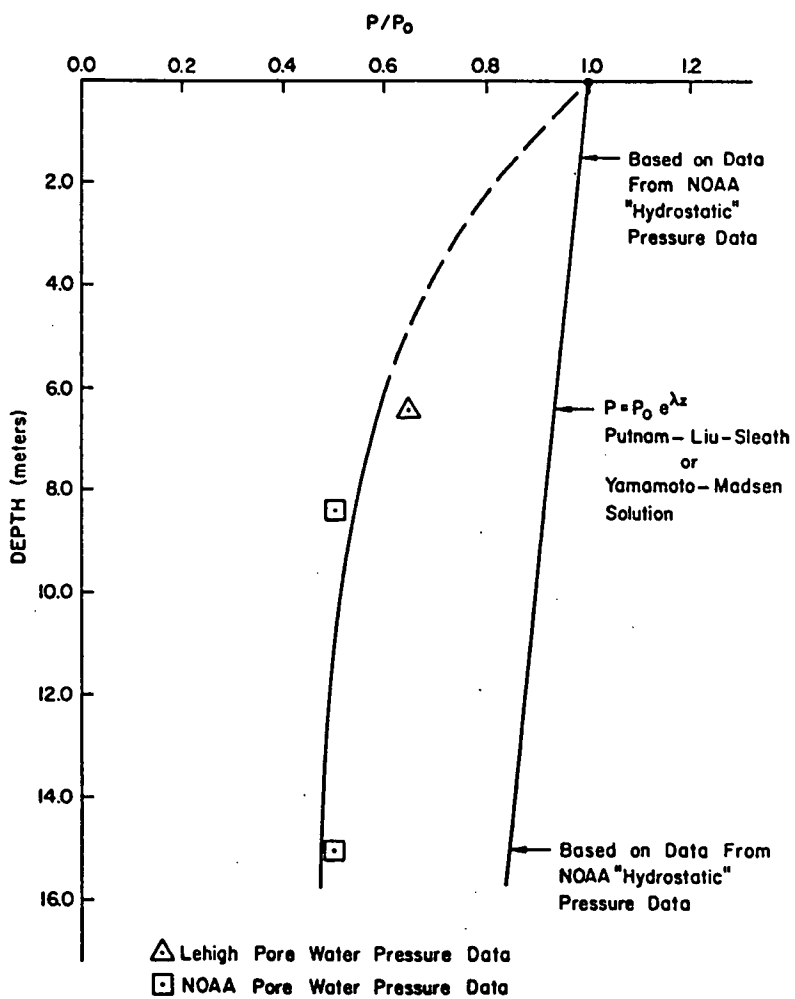

Fig. 3.27

"Hydrostatic" and pore water pressures from SEASWAB I. (after Clukey et al., 1983).

attributed to some type of failure or collapse mechanism (Clukey, Kulhawy and Liu, 1983). However, there are some problems relating to this data that are as yet unresolved. The pore water pressure level reached during the storm made the vertical effective stress negative by $10 - 20 \text{ kN/m}^2$ (Williams, Dunlap and Hanse, 1981). These data were recorded by a Texas A and M - USGS probe.

Data were also recorded on a NOAA probe, installed much later, for waves between 0.9 and 1.5 m in height. No attenuation was noted down to 6.4 m below the mudline. Significant attenuation was noted by a transducer at a depth of 15.5 m. (Bennett and Faris, 1979). Yamamoto (1981) reported that his analytical model was in good agreement with the data collected from this experiment, if the degree of saturation is taken between 90% - 100% as in Fig. 3.28.

e) CONCLUSIONS FROM FIELD TESTS.

The data from the field tests in cohesionless materials are roughly in agreement with solutions based on the equations of a poroelastic solid. The SWOOP Pacifica tests are probably the most useful in checking the analytical methods because the probes were deep enough to avoid the development of residual pore water pressures, and gas charging of the sediments was not a problem. Response computed by STAB-MAX agreed well with the measured pore water pressures, except at one location.

The shallow depth data at Pacifica from the fine sand layer probably included some residual pore water pressures, from the large waves which passed before the probe was installed. Any

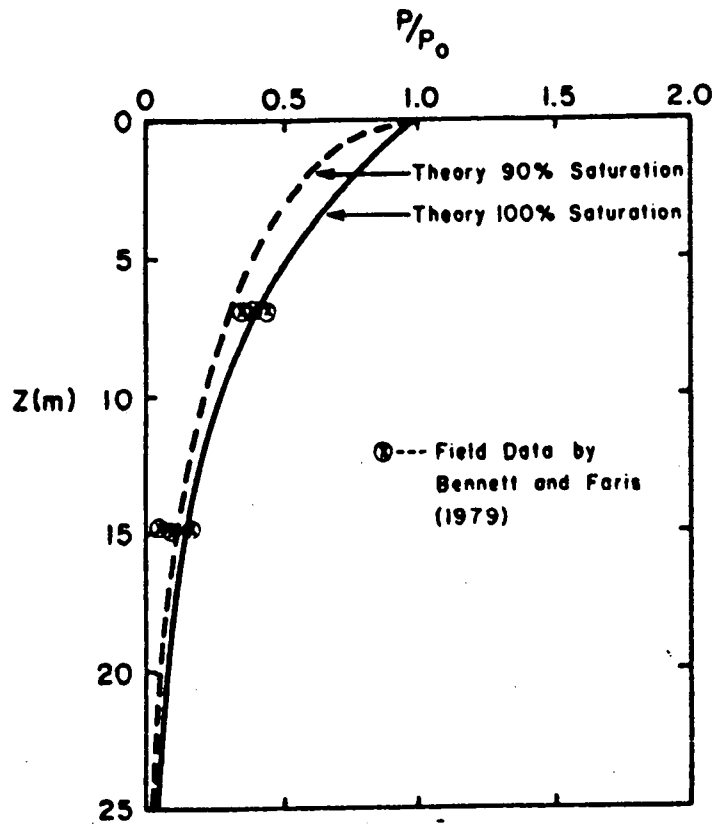

Fig. 3.28

Comparison between SEASWAB II field data and Yamamoto (1978) theory (Yamamoto 1981).

analysis of offshore pore water pressure data should take into account both transient and residual pore water pressures, unless residual pore water pressures are clearly not present.

The shallow test data from Shimizu harbour comes from only depth, and therefore, is not comprehensive enough to define attenuation with depth but it does show clearly, in accordance with all the theories, that the pressure wave attenuates more rapidly with decreasing period.

The SEASWAB tests in highly elastic gas-charged sediments do not provide enough data for a definitive check of any of the poroelastic theories because the degree of saturation is unknown. Yamamoto (1981) showed very good agreement with the field data when he assumed that the degree of saturation was between 90% - 100%.

3.5 RESIDUAL PORE WATER PRESSURES AND LIQUEFACTION POTENTIAL

a) SEED-RAHMAN METHOD

Seed and Rahman (1977) have proposed a method for estimating the liquefaction potential of seafloor sands under wave loading, and the magnitudes of the residual pore water pressures. They represent the complex pattern of storm waves by packets of uniform harmonic waves, with height, period, and length of the wave being specified for each packet. The shear stresses, τ_{xz} , generated by each wave type are computed assuming elastic behaviour. For deep sand deposits with fairly uniform stiffness, (3.15) may be used. For layered soils, a computer-based numerical solution of the equations of elasticity is used. The

initial vertical effective stress, σ'_{vo} , at any depth, is determined from a knowledge of the buoyant unit weights of the overlying materials. The cyclic stress ratios, τ_{xz}/σ'_{vo} , at the top of the seabed induced by the different wave components may now be computed. The number of cycles of each stress ratio may be converted to an equivalent number of cycles of a specified stress ratio, τ_e/σ'_{vo} , e.g., the stress ratio at the seafloor equivalent to the significant wave height, using procedures developed by Seed et al., (1975). In this way the complex storm is reduced to an equivalent storm with waves of uniform height. The stress ratios, τ_e/σ'_{vo} , generated by the uniform storm at any depth in the seabed are then computed.

The pore water pressures, u_g , may now be determined using the following equation (Seed, Martin and Lysmer, 1976)

$$\frac{u_g}{\sigma'_{vo}} = \frac{2}{\pi} \arcsin \left(\frac{N}{N_1} \right)^{1/2\theta} \quad (3.17)$$

in which N_1 = the number of cycles of τ_e/σ'_{vo} which cause liquefaction. The value of $\theta = 0.7$ is typical of many medium sands.

b) ANALYSIS BY COMPUTER PROGRAMS STAB-W AND STAB-W3

A computer program, STAB-W, has been developed by Siddharthan and Finn (1979b) for predicting residual pore water pressures and estimating liquefaction potential under wave loading. The program is a generalization of the Seed-Rahman (1977) method, and includes the effects of increasing pore water pressures during a storm on the shear and bulk moduli.

The program transforms the actual complex storm into an

equivalent storm with all waves of a selected uniform height, such as the height of the significant wave. Equivalency is defined in terms of potential to cause liquefaction, and the liquefaction resistance curve for the seafloor sands is used as a weighting curve in the transformation process. The program computes the pore water pressures from the equivalent storm, taking into account the simultaneous processes of generation and dissipation of pore water pressure. This is accomplished by solving the usual consolidation equation modified by a term for pore water pressure generation, $\partial u_g / \partial t$ (Finn, Lee and Martin, 1976). The rate of generation is controlled by (3.17).

Yogendrakumar, Siddharthan and Finn (1983) refined the analysis in STAB-W, by introducing a complete cubic polynomial interpolation function for the pore water pressure field in the finite element representation, instead of the linear interpolation previously used. This refined representation allows the use of two nodal variables, the pore water pressure and the flow, thus providing a complete picture of what is happening hydraulically in the bed, and making it much easier to understand the patterns of pore water pressure distribution, especially in layered systems.

During a storm, after a residual pore water pressure, u , has developed, the mean normal effective stress, σ'_m , has been reduced along with the shear and bulk moduli which are functions of σ'_m . Therefore, the shear and bulk moduli are recalculated and the stress analysis is repeated using the new moduli. The moduli and cyclic stress ratios are continually updated as the pore water pressures increase during the storm.

The effect of the reduction in shear and bulk moduli on the development of pore water pressures is shown in Fig. 3.29. Residual wave-induced pore water pressures in the 18.5 m thick seabed, described previously, were computed using STAB-W. Pore water pressure dissipation was taken into account for two different permeabilities. Two types of analysis were conducted: in one, the moduli were not modified for the changes in pore water pressure, while they were in the other. The results in Fig. 3.29 show that modifying the soil properties, for the effects of pore water pressure, has a noticeable impact on the predicted pore water pressures. When the degradation in moduli are taken into account, the predicted pore water pressures are about 20% higher in the more permeable sands, and the depth of liquefaction is increased substantially in the less permeable sands. The effect of degrading moduli on pore water pressure response needs more thorough investigation before any firm conclusions can be drawn about its importance. However, based upon present evidence, it would seem prudent to include this effect in analyses of liquefaction potential as is done in STAB-W or STAB-W3.

3.6 FIELD AND LABORATORY DATA ON RESIDUAL PORE WATER PRESSURE

Very few data are available on residual pore water pressures due to wave loading. What data there is, is mixed in with the pressures developed by poroelastic coupled response of soil and water. The only reasonably documented case of liquefaction and failure due to high residual pore water pressures induced by wave

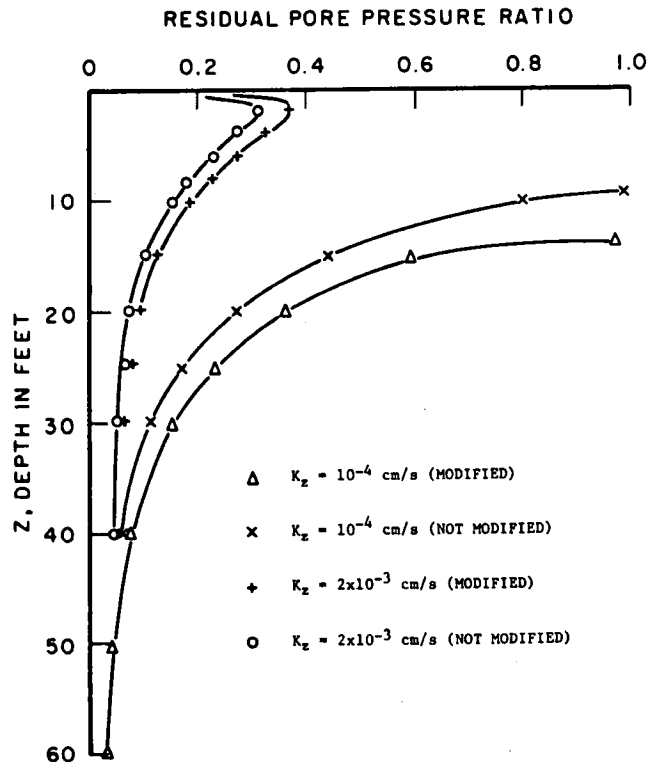

Fig. 3.29

Effect of soil softening and permeability on pore water pressure response.

loading is the test series on silt beds in the Cornell wave tank (Clukey, Kulhawy and Liu, 1983).

a) CORNELL LABORATORY TESTS ON SILT.

The silt tests are particularly interesting because they demonstrate convincingly the phenomenon of liquefaction under wave loading. All the transducers indicate a steady build up in pore water pressure. This accumulation of pressure is possible because the low permeability of the silt (4×10^{-8} cm/s) prevents any dissipation during the time of the test. The accumulation did not occur in the sand tests because of a much higher permeability, of the order of 10^{-3} cm/s.

A typical example of pore water pressure development is shown in Fig. 3.30. In this test run, data collection was terminated while the pressure was still rising. A more dramatic example is shown in Fig. 3.31 which shows a build-up in pore water pressure high enough to result in failure and liquefaction.

The cyclic stress ratios, τ_{xz}/σ'_{vo} , in the deposit were computed using the Finn, Siddharthan and Martin (1983) simplified analysis. In this ratio, τ_{xz} = horizontal wave induced shear stress and σ'_{vo} = initial vertical effective stress. The computed cyclic stress ratios were plotted against the number of observed cycles to failure or liquefaction as in Fig. 3.32. Also shown in Fig. 3.32 is the cyclic stress ratio for a very similar silt measured in a cyclic simple shear test on a reconstituted sample. Data from cyclic triaxial tests adjusted to simple shear conditions and obtained under much higher confining pressures result in denser and, hence, stronger samples. The cyclic shear

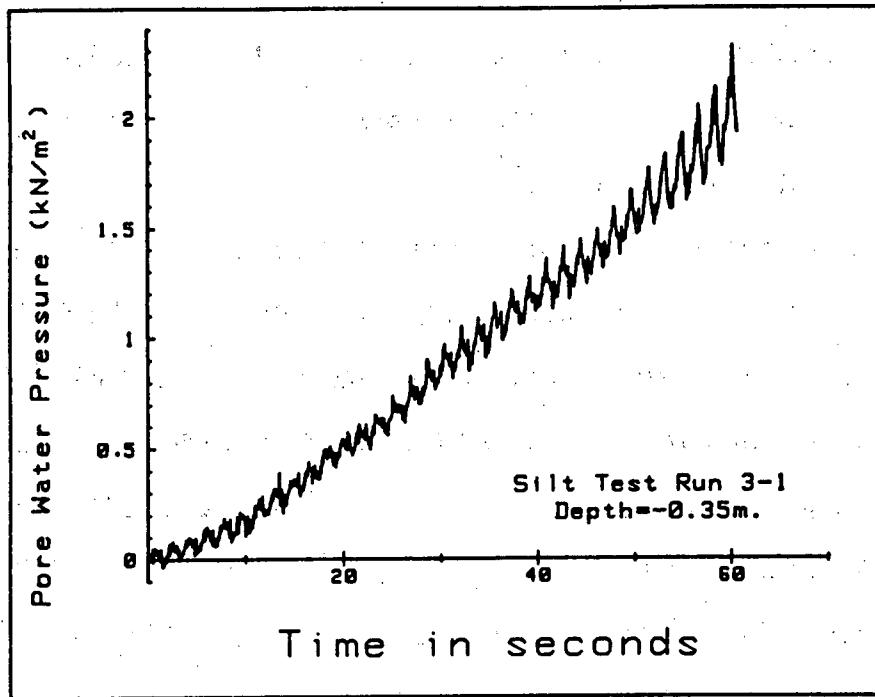

Fig. 3.30

Progressive increase in residual pore water pressure (after Clukey et al., 1983).

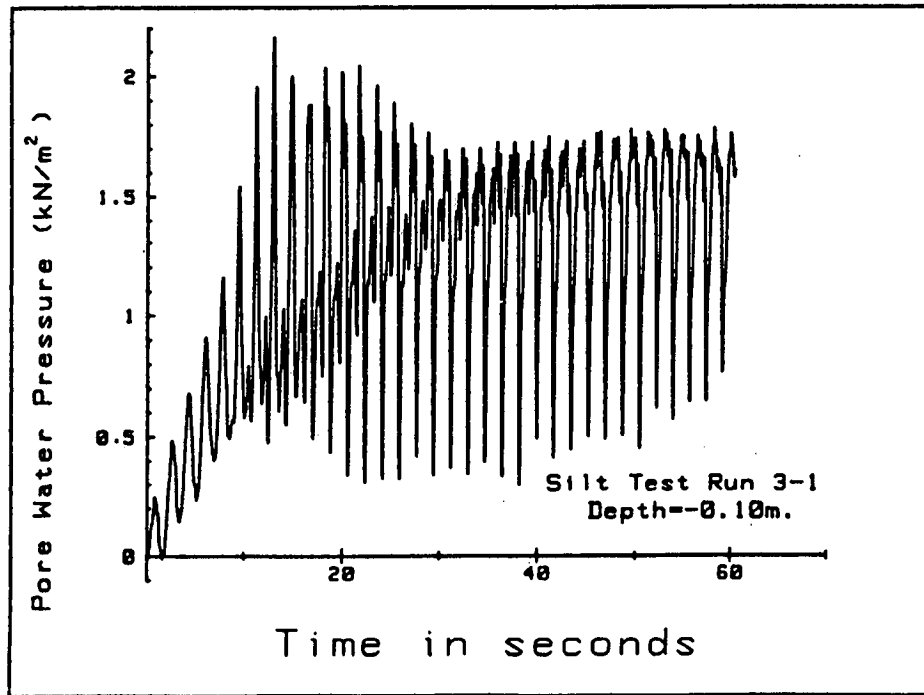

Fig. 3.31

Residual pore water pressures leading to liquefaction (after Clukey et al., 1983).

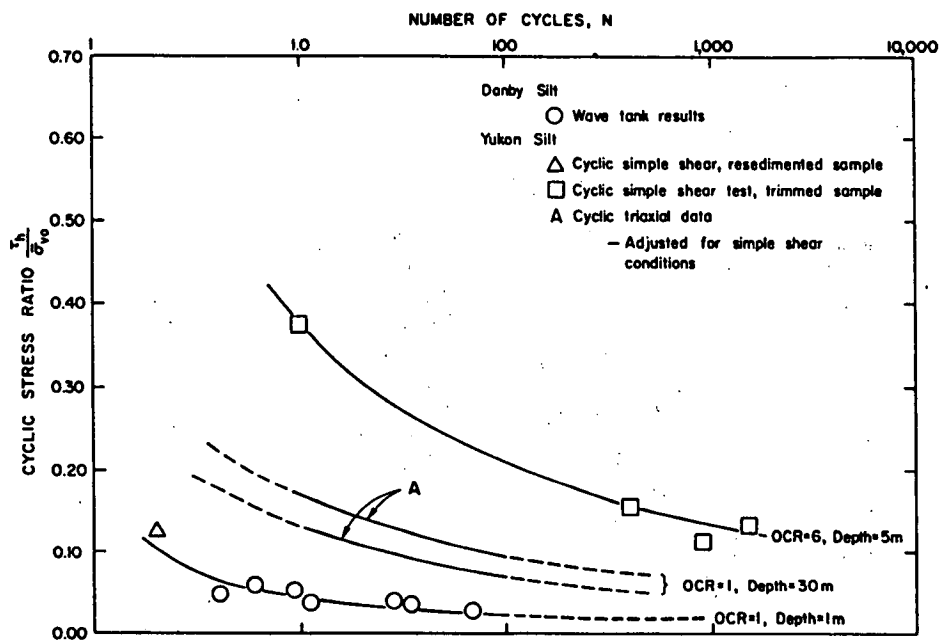

Fig. 3.32 Liquefaction potential curves for Yukon and Danby silts (after Clukey et al., 1983).

stress ratios required to cause failure or liquefaction were generally less than 0.10 for the very loosely sedimented condition in the wave tank.

The Cornell tests are the first to provide quantitative data on the incidence of wave induced liquefaction. More of this kind of data is essential in order to check the methods proposed for predicting the phenomenon, such as the Seed-Rahman (1977) method or the Siddharthan-Finn (1979b) method.

b) FIELD DATA ON RESIDUAL PORE WATER PRESSURES

(i) Ekofisk Tank.

The Ekofisk Tank was installed in the North Sea in June 1973. It is 93 m in diameter and 90 m high and rests on the natural foundation of very dense sands in 70 m of water. Shortly after installation the tank was subjected to major storms with wave heights over 20 m. In one instance a wave height of 24 m was reached. The maximum pore water pressure induced under the tank was about 16% of the effective overburden pressure.

Rahman, Seed and Booker (1977) analysed the response of the tank to the measured wave climate. The analysis were conducted using the procedures described earlier for estimating residual pore water pressures, except for the computation of the cyclic shear stresses. In this case, the cyclic shear stresses were determined by a finite element analysis of the structure-foundation system, under the action of wave loading.

The relative density D_r of the sand in situ was estimated to be about $D_r = 100\%$ (Lee and Focht, 1975). Rahman, Seed and Booker (1977) conducted residual pore water pressure analyses for

relative densities of $D_r = 77\%$ and $D_r = 85\%$. They found that the minimum pore water pressures occurred at the centre of the tank and the maximum at the edge. The range in pore water pressures was found to be 16% - 32% of the effective overburden pressure for $D_r = 77\%$, and 8%-22% for $D_r = 85\%$. Had the higher relative density $D_r = 100\%$ been used, the computed pressures would have been somewhat less.

Although the residual pore water pressures were computed under very complex conditions, the agreement between the predicted range in pore water pressures and those induced by the storm is adequate for design purposes.

(ii) Ekofisk - Emden Pipeline.

A section of the Ekofisk-Emden gas pipeline near the German Coast, which had been buried, was exposed in a trench over a length of 3 to 5 km. Exposure resulted from wave-induced liquefaction which occurred during a major storm in January 1976. The line was reburied and screw-anchors installed.

3.7 ASSESSMENT OF SEAFLOOR STABILITY

The stability of a level seafloor may be assessed using the program STAB-MAX. In addition to computing the pore water pressures and the wave-induced effective stress increments, the program checks whether the resulting system of effective stresses violates the Mohr-Coulomb failure criterion. To check the stability, the program computes the mobilized effective angle of friction ϕ' and compares it with the angle of internal friction ϕ'_f corresponding to whatever condition is defined as failure,

whether peak angle, residual angle or failure defined by a strain criterion.

The mobilized angle of friction ϕ' in terms of the stresses computed by STAB-MAX is given by

$$\sin \phi = \frac{[(\bar{\sigma}_z - \bar{\sigma}_x)^2 + 4\bar{\tau}_{xz}^2]^{1/2}}{\bar{\sigma}_z + \bar{\sigma}_x} \quad (3.18)$$

This expression is easily derived from the Mohr's Circle for instantaneous stresses shown in Fig. 3.33 (Yamamoto, 1981). The stresses in the expression are the sum of the initial effective stress and the stress increments induced by the waves. A typical output from a plotting routine is shown in Fig. 3.34. This shows contours of the mobilized angle of friction. Any areas containing angles of friction ϕ' greater than ϕ'_f are considered unstable.

The initial properties of the soil such as shear modulus and bulk modulus are dependent on the initial effective stresses. At many offshore sites not only transient but residual pore water pressures are generated. The effects of residual pore water pressures on the effective stresses in situ must be taken into account in determining the soil moduli for use in a poroelastic analysis such as STAB-MAX. This is usually not done. The residual pore water pressures may be computed using STAB-W or STAB-W3. By softening the seafloor soils, the residual pore water pressures ensure that larger strains will be predicted by poroelastic analysis. The transient pore pressure regime will therefore be changed and so will the computed wave-induced effective stresses. Since both wave-climate and residual pore

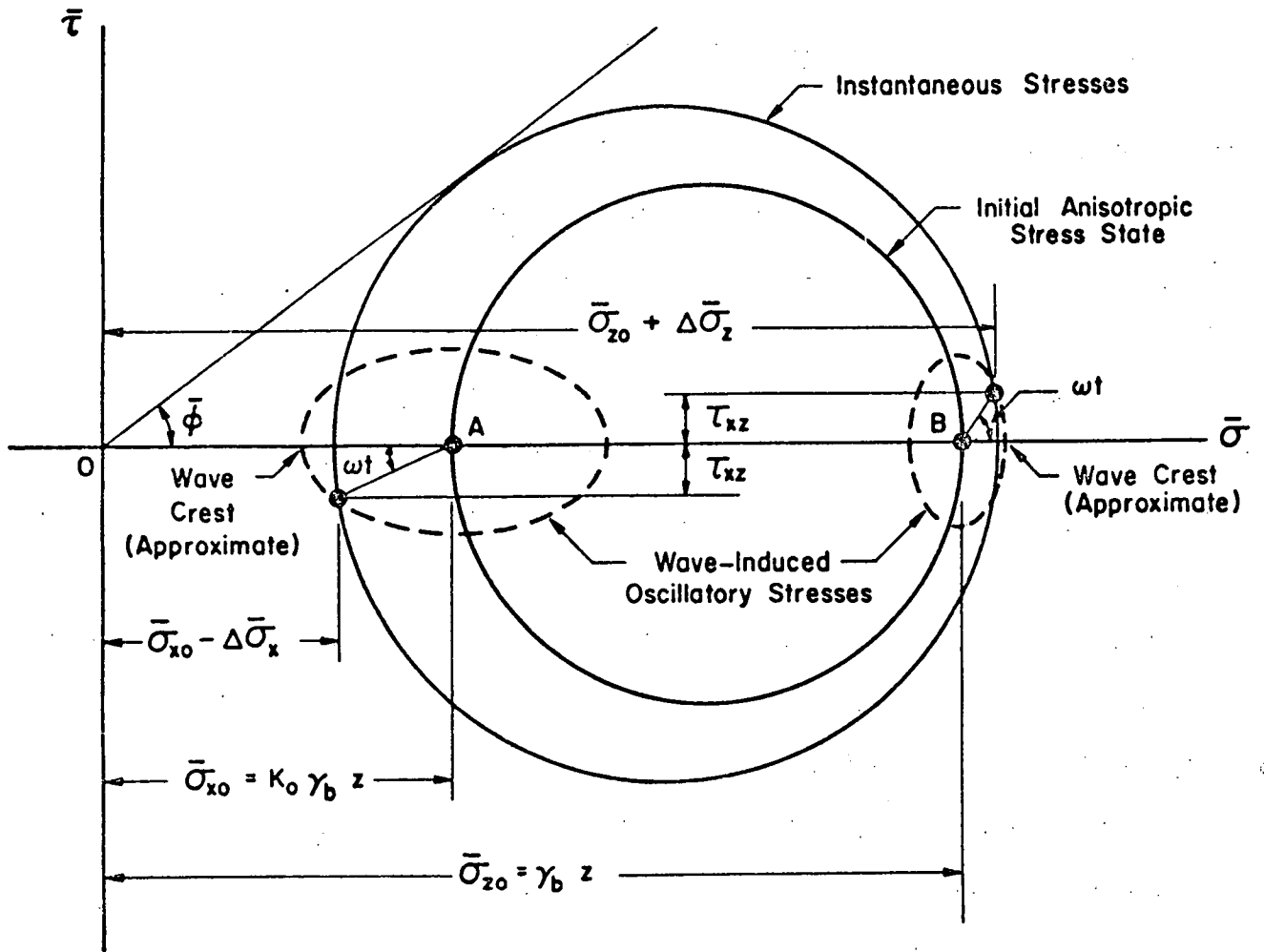

Fig. 3.33

Mohr circle of wave induced stresses (after Yamamoto, 1978).

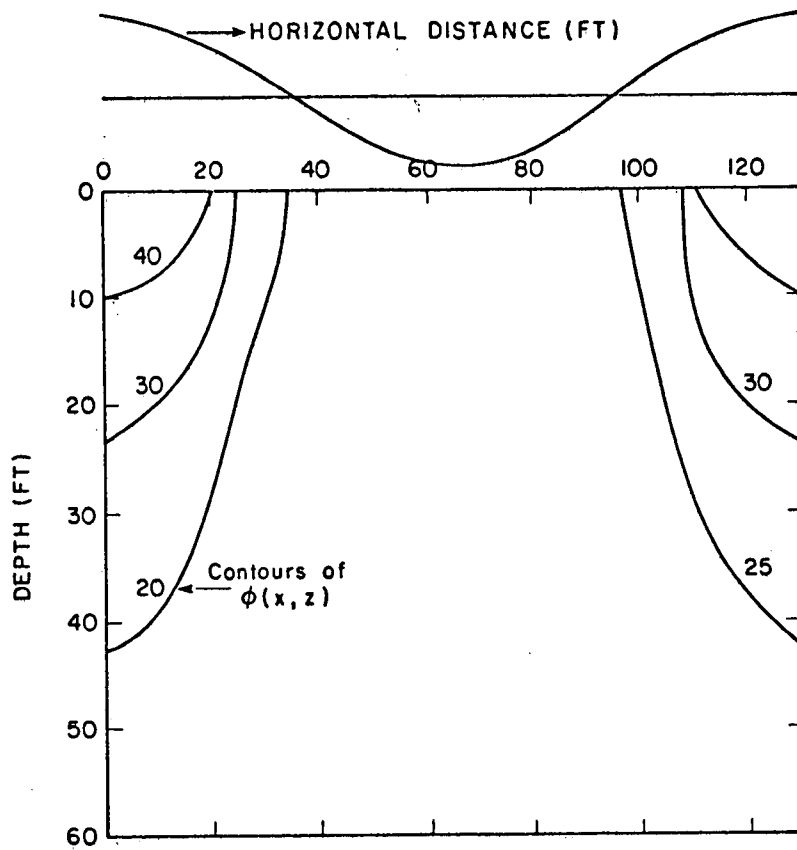

Fig. 3.34

Contours of developed angle of friction ϕ' .

water pressure will be changing during a storm, stability analyses should be conducted at various intervals to ensure that the worst combination of wave heights and residual pore water pressures is covered.

Simple stability analyses may also be conducted using effective stresses and pore water pressures deduced from the simple uncoupled analysis. The selection of the equation for estimating pore water pressure should be based on the information given in Section (3.2).

All the poroelastic analyses described above, as well as the equations for the uncoupled determination of pore water pressures, are free field solutions and should not be applied without modification in the vicinity of structures, even relatively small structures, such as pipelines. On the basis of Putnam's assumptions, MacPherson (1978) computed the pore-water pressure field around a pipeline buried in an infinitely deep seafloor deposit. The net seepage force was found to be constant but its direction depended on the location of the pipe in relation to the wave crest. The maximum upward seepage force occurred when the trough was over the pipe. Under extreme conditions, he found that the upward seepage force on the pipe was 20%-30% of the weight of water displaced by the pipe. Similar analysis by the writer, in which he integrated Putnam's solution around the pipe, resulted in seepage forces between 20%-30% of the weight of displaced water. These differences are significant, and it is clear that calculations of the stability of a buried pipeline under seepage and buoyant forces should take into account the perturbation of the pore water pressure field by

the pipe. Liu et al. (1979) extended MacPherson's analysis to shallow deposits and to the case of two adjacent pipes. They found that if the pipes are close together, the seepage forces on the pipe are 25%-40% of the weight of water displaced by the pipe.

The analyses incorporated in the STAB-MAX and STAB-W programs are based on the assumption of a level seafloor. In practice, the programs may be used also for gentle slopes. As the slope increases, the predictions of pore water pressures by these programs becomes increasingly conservative. The conservatism arises from two sources: draining from a sloping seafloor is faster than from a level one, and the static shear stresses induced in a sloping seafloor tend to retard the rate of development of pore water pressure (Vaid and Finn, 1979).

Finn and Lee (1979) proposed an effective stress method of stability analysis for use with steeper slopes for which STAB-MAX and STAB-W would be inappropriate. The basic form of the problem is shown in Fig. 3.35. A potential failure surface is assumed, and the equilibrium of the sliding mass of unit thickness bounded by the failure surface and the surface of the slope, is investigated. The failure surface may have any shape, and plane strain deformation is assumed.

The active force system consists of gravity loading, wave pressures on the seafloor, and transient and residual pore water pressures acting on the failure surface. The transient pore water pressures in many cases of interest can be estimated by appropriate pore water pressure attenuation relationships as

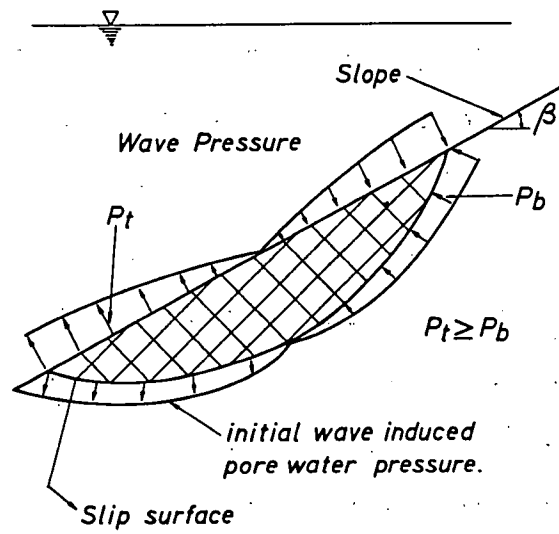

Fig. 3.35 Wave induced forces on a slope.

described previously. A factor of safety of unity is now assumed and the number of cycles of loading, N , required to raise the residual pore water pressure to a level that causes instability, is computed. N may be compared with the number of effective loading cycles considered equivalent to the wave loading in order to estimate a margin of safety against failure. Pore water pressure dissipation is taken into account.

Alternatively, the seafloor pressures may be assumed to be not attenuated and applied at the base of the slip surface. The analysis may then be carried out using one of the conventional methods of slices. Such a procedure may be adequate for relatively shallow slip surfaces.

Most analyses of the stability of the seafloor and underwater slopes reported in the literature have been in the Gulf of Mexico, and in Norton Sound and the Copper River Delta of Alaska. The seafloor materials have been primarily clays and silts with very low permeabilities. As a consequence most of the analyses have been total stress analyses. There is little quantitative information available on the performance of seafloor sands under wave loading, and few descriptions of any effective stress analyses.

The liquefaction potential of the seafloor is a major consideration in assessing the stability of buried pipelines and gravity structures. Liquefaction is most likely in fine sands and silts, because the low permeability of these soils prevents significant dissipation of residual pore water pressure during a storm. The residual pore water pressures may be computed using STAB-W or STAB-W3. The soils are said to have liquefied when the

residual pore water pressures become equal to the effective overburden pressure.

When liquefaction is deemed to occur as defined above, it is common practice in offshore design to consider that the soil is now transformed into a dense fluid with the unit weight of the soil-water mixture. It is then assumed that any pipe with positive buoyancy will pop to the surface and a pipe with negative buoyancy will sink.

Decisions regarding stability are generally simple when complete liquefaction is possible. For situations involving lesser residual pore water pressures, stability must be assessed by continuum stress analysis or by limiting equilibrium methods.

In the application of effective stress methods of analysis to offshore problems, concentration on the wave-induced residual and transient pore water pressures should not divert attention from other components of the total pore water pressure that may be present as well. For example, excess pore water pressures may exist in situ due to underconsolidation of fine silts or artesian conditions.

3.8 EVALUATION OF CURRENT METHODS OF ANALYSIS

All methods for determining the wave-induced pore water pressures and increments of effective stresses, except the uncoupled analysis, are based on the same constitutive model, Biot's (1941) equations for a poroelastic solid. Some of the methods include more features than others but they all rest on the same basis. The fundamental question, then, is how well does

the poroelastic model correspond to field conditions.

On the basis of the wave tank studies and the very limited offshore testing program, the poroelastic model appears to adequately predict wave-induced pore water pressures in sands. In many of the wave tank studies, crucial data was not available, so that a rigorous examination of the poroelastic model was not possible. However, the model does have the capability to include many of the factors that exert a major influence on response, such as the degree of saturation, the anisotropic permeability ratio and the layering in the seafloor.

Poroelastic analysis is the best and only method currently available for estimating the transient effects of waves.

The computation of residual pore water pressure is based on techniques that have been used very successfully for many years to determine the effects of seismic waves on saturated sands. For this reason, there is a measure of confidence in the application of these techniques in the offshore environment to analyze the effects of waves on seafloor soils. However there is very little quantitative data on how effective the techniques are offshore. As in the case of transient effects, there is only one method available for analysis.

The most general forms of transient and residual analysis for layered systems are currently incorporated in the computer programs STAB-MAX and STAB-W.

3.9 FUTURE RESEARCH NEEDS

The extensive review of wave-tank studies and field experiments gives a good indication of the areas in which further

investigation of the problem of wave-sediment interaction may be fruitful. These are presented separately for analyses of transient and residual conditions.

a) TRANSIENT ANALYSES.

The capability of the methods of poroelastic analysis to predict the increments in vertical and horizontal effective stresses, due to wave loading, has not been adequately established. The agreement between theory and data is fairly poor. It is an open question whether the difficulties in predicting the effective stresses with sufficient accuracy is due to deficiencies in the theory or experimental problems. This very important question may be resolved by further wave-tank studies.

Further field studies are desirable to check the capability to predict the wave-induced pore water pressures in situ, especially in naturally layered systems. The tests should be conducted at a well documented site, with no gas charging and preferably permeable enough, or dense enough, to prevent the development of residual pore water pressures. This will remove the need to include these effects in the poroelastic analysis. At least four pore water pressure transducers should be deployed in any vertical line, to define adequately the vertical distribution of pore water pressures and any phase differences that develop with depth.

b) RESIDUAL PORE WATER PRESSURES.

The analysis for residual pore water pressures is used

widely in practice, and the results of such analyses have substantial economic implications for pipeline burial, skirt penetration and platform design. Yet there is no documented study of how well the method predicts the pore water pressures in practice. It would seem an imperative to undertake sufficient studies to validate the method.

Further wave tank studies on silts, similar to those conducted by Clukey, Kulahwy and Liu (1983), would provide useful data on pore water pressures and failure mechanisms in fairly uniform deposits.

Field studies should also be conducted to check how the method copes with natural soil conditions and the irregular wave climate offshore. Sufficient pore water pressure transducers should be deployed vertically to define the distribution of pore water pressures unambiguously. The field studies should be conducted in very fine sands or silts to ensure that significant residual pore water pressures will develop during a storm.

3.10 REFERENCES

- Bennett, R.H. and R.J. Faris, 1979, "Ambient and dynamic pore pressures in fine-grained submarine sediments: Mississippi Delta," Applied Ocean Research, Vol. 1, No. 3, pp. 115-123.
- Biot, M.A., 1941, "General theory of three-dimensional consolidation," Journal of Applied Physics, Vol. 12, pp. 155-164.
- Christian, J.T., P.K. Taylor, J.K.C. Yen, and R.E. David, 1974, "Large diameter underwater pipeline for nuclear power plant designed against soil liquefaction," Proceedings, Sixth Annual OffShore Technology Conference, Houston, Texas, Paper No. OTC 2094, pp. 597-606.
- Clukey, C.E., F.H. Kulhawy, and P.L.-F. Liu, 1983, "Laboratory and field investigation of wave-sediment interaction", Geotechnical Engineering Report 83.9, School of Civil and Environmental Engineering, Cornell University, Ithaca, New York,
- Cross, R., S.R. Huntsman, D.D. Treadwell, and V.A. Baker, 1979, "Attenuation of wave-induced pore pressures in sand," Proceeding, 4th International Conference on Civil Engineering in the Oceans, San Francisco, Calif., pp. 745-757.
- Dunlap, W.A., W.R. Bryant, R. Bennett, and A.F. Richards, 1978, "Pore pressure measurements in unconsolidated sediments," Proceedings, Tenth Offshore Technology Conference, Vol. 2, Houston, TX, pp. 1049-1056.
- Finn, W.D.L., S. Iai, and K. Ishihara, 1982, "Performance of artificial offshore islands under wave and earthquake Loading: field data analyses," Proceedings, Offshore Technology Conference, Houston, TX, Vol. 1, Paper No. OTC 4220, pp. 661-672.
- Finn, W.D.L., K.W. and Lee, 1969, "Seafloor stability under seismic and wave loading", presented at the Soil Dynamics in the Marine Environment, ASCE National Convention and Exposition, held at Boston, Mass. (Preprint 3604).
- Finn, W.D.L., K.W. Lee, and G.R. Martin, 1976, "An effective stress model for liquefaction," Journal of the Geotechnical Engineering Division, ASCE, Vol. 103, No. GT6, Proc. 13008, pp. 517-533.
- Finn, W.D.L., and G.R. Martin, 1979, "Analysis of piled foundations for offshore structures under wave and earthquake loading", Proceedings, Paper No. 38, Second

International Conference on Behaviour of OffShore Structures, London, England.

- Finn, W.D.L., and G.R. Martin, 1980, "OffShore pile foundations in sand under earthquake loading," Applied Ocean Research, Vol. 2, No. 2, pp. 81-84.
- Finn, W.D.L., R. Siddharthan, and G.R. Martin, 1983, "Response of sea floor to ocean waves," Journal of the Geotechnical Engineering Division, ASCE, Vol. 109, No. 4, pp. 556-572.
- Fung, Y.C., 1965, Foundations of soil mechanics, Prentice-Hall, Englewood Cliffs, N.J., pp. 195-197.
- Henkel, D.J., 1970, "The role of waves in causing submarine landslides", Geotechnique 20, No. 1, pp. 75-80.
- Hirst, T.J. and A.F. Richards, 1977, "In-situ pore pressure measurements in Mississippi Delta front sediments," Marine Geotechnology, Vol. 2, 191-204.
- Lee, K.L., and J.A. Focht, Jr., 1975, "Liquefaction potential at ekofisk tank in North Sea," Journal of the Geotechnical Engineering Division, ASCE, Vol. 101, No. GT1, Proc. Paper 11054, pp. 1-18.
- Lindenberg, J., J.H. Swart, C.J. Kenter, and K. den Boer, 1982, "Wave induced pressures underneath a caisson: a comparison between theory and large scale experiments," Proceedings, Third International Conference on Behavior of Offshore Structures, Vol. 1, Cambridge, MA, pp. 337-357.
- Liu, P.L.-F., 1973, "Damping of water waves over a porous bed," Journal of the Hydraulics Division, ASCE, Vol. 99, No. HY12, pp. 2263-2271.
- Liu, P.L.-F., P. Timothy, and O'Donnell, 1979, "Wave induced forces on buried pipelines in permeable seabeds," Proceedings, 4th Conference on Civil Engineering in the Oceans, San Francisco, Calif., pp. 111-121.
- McDougall, W.G., C.K. Sollitt, T.S. Vinson, and J.R. Bell, 1981, "Ocean wave geotextile interaction," SEA Grant Report on Grant NO. NA79AA-D_00106, Oregon State University, Corvallis, OR, 143 p.
- MacPherson, H., 1978, "Wave forces on pipeline buried in permeable seabed," Journal of the Waterway, Port, Coastal and Ocean Division, ASCE, Vol. 104, No. VW4, pp. 407-419.
- Madsen, O.S., 1978, "Wave induced pore pressures and effective stresses in a porous bed," Geotechnique 28, No. 4, pp. 377-393.

- Mallard, W., and R.A. Dalrymple, 1977, "Water waves propagating over a deformable bottom," Proceedings, Ninth Annual Off-Shore Technology Conference, Houston, Tex. pp. 141-146.
- Martin, G.R., W.D.L. Finn, and H.B. Seed, 1975, "Fundamentals of liquefaction under cyclic loading," Journal of the Geotechnical Division, ASCE, Vol. 101, No. GT5, Proc. Paper 11284, pp. 423-438.
- Moshagen, H., and A. Tørum, 1975, "Wave induced pressures in permeable seabeds," Journal of Waterways, Harbor and Coastal Engineering, ASCE, Vol. 101, No. WW1, pp. 49-58.
- Okusa, S. and A. Uchida, 1980, "Pore water pressure changes in submarine sediments due to waves," Marine Geotechnology, Vol. 4, No. 2, pp. 145-161.
- Putnam, J.A., 1949, "Loss of wave energy due to percolation in a permeable sea bottom," Transactions, American Geophysical Union, Vol. 30, pp. 349-356.
- Rahman, M.S., H.B. Seed, and J.R. Booker, 1977, "Pore pressure development under offshore gravity structures," Journal of the Geotechnical Engineering Division, ASCE, Vol. 103, No. GT12, pp. 1419-1436.
- Seed, H.B., I.M. Idriss, F. Makdisi, and J. Banerjee, 1975, "Representation of irregular stress time histories by equivalent uniform stress series in liquefaction analyses," Report No. EERC 75-29, Earthquake Engineering Research Center, University of California, Berkeley, Calif.
- Seed, H.B., P.P. Martin, and J. Lysmer, 1976, "Porewater pressure changes during soil liquefaction," Journal of the Geotechnical Engineering Division, ASCE, Vol. 102, No. GT4, Proc. Paper 12074, pp. 323-346.
- Seed, H.B., and M.S. Rahman, 1977, "Analysis for wave-induced liquefaction in relation to ocean floor stability," Report No. UCB/TE-77/02, University of California, Berkeley, Calif.
- Siddharthan, R., W.F. Liam Finn, 1979a, "STAB-MAX: Analysis of instantaneous instability induced in seafloor sands by large waves," Soil Dynamics Group, Faculty of Graduate Studies, University of British Columbia, Vancouver, British Columbia, Canada.
- Siddharthan, R., and W.D. Liam Finn, 1979b, "STAB-W: Analysis of instability in seafloor sands by cumulative effects of waves," Soil Dynamics Group, Faculty of Graduate Studies, University of British Columbia, Vancouver, British Columbia, Canada.

- Sleath, J.F.A., 1970, "Wave-induced pressures in beds of sand," Journal of the Hydraulics Division, ASCE, Vol. 96, No. HY2, pp. 367-378.
- Tsui, Y. and S.C. Helfrich, 1983, "Wave induced pressures in submerged sand layer," Journal of the Geotechnical Engineering Division, ASCE, Vol. 109, No. 4, pp. 603-618.
- Vaid, Y.P., and W.D. Liam Finn, 1979, "Effect of static shear on liquefaction potential," Journal of the Geotechnical Engineering Division, ASCE, Vol. 105, No. GT10, Proc. Paper 14909, pp. 1233-1246.
- Verruijt, A., 1969, "Elastic storage of aquifers," Chapter 8, Flow Through Porous Media, R.J.M. De Wiest, Editor, Academic Press Publishers, New York, N.Y.
- Williams, G.N., W.A. Dunlap, and B. Hansen, 1981, "Storm induced bottom sediment data," Proceedings, Thirteenth Offshore Technology Conference, Vol. 1, Houston, TX, pp. 853-862.
- Yamamoto, T., 1977, "Wave induced instability in seabeds", Coastal Sediments 77, ASCE, Charleston, SC. pp. 898-913.
- Yamamoto, T., 1978, "Sea-bed instability from waves," Proceedings, Tenth Offshore Technology Conference, Vol. 1, Houston, TX, pp. 1819-1828.
- Yamamoto, T., 1981, "Wave induced pore pressures and effective stresses in inhomogeneous seabed foundations," Ocean Engineering, Vol. 8, No. 1, pp. 1-16.
- Yamamoto, T., 1983, "On the response of a Coulomb-damped poroelastic bed to water waves" Marine Geotechnology, Vol. 5, No. 2, pp. 93.127.
- Yamamoto, T., H.L. Koning, H. Sellmejer, and E. van Hijum, 1978, "On the response of a poroelastic bed to waterwaves," Journal of Fluid Mechanics, Vol. 87, No. 1, pp. 193.206.
- Yamamoto, T., S. Takahashi, and B. Schuckman, 1983, "Physical modeling of sea-seabed interactions," Journal of Engineering Mechanics, ASCE, Vol. 109, No. 1, pp. 54-72.
- Yogendrakumar, M., R. Siddharthan, and W.D. Liam Finn, 1983, "STAB-W3. Program for computing residual pore water pressures in sands and silts due to wave loading" Soil Dynamics Group, Faculty of Graduate Studies, University of British Columbia, Vancouver, B.C. Canada.

CHAPITRE 4

TECHNIQUES DE TRACAGE

by

BERNARD LONG

INRS - Océanologie
Université du Québec

4.1 INTRODUCTION

Le problème de l'entraînement des particules par les agents hydrodynamiques (courants et houles) n'est pas résolu par les différentes équations de transport existantes dans la littérature. Or de nombreuses expériences réalisées dans des conditions très variées montrent que les traceurs sédimentaires représentent souvent un moyen irremplaçable pour qualifier ou quantifier les transports sédimentaires. Les traceurs naturels ont permis de mettre en évidence les grands axes de transport le long des littoraux comme la détermination du sens de la dérive littorale (McLaren, 1981) ou les mises en place des sédiments par des paléocours d'eau sur le plateau continental (Hudson et Ehrlich, 1980; Ehrlich et al., 1980). L'utilisation des traceurs artificiels a permis de développer des études plus ponctuelles répondant à des problèmes de génie civil. Par exemple, durant un transport par charriage, les données recueillies in situ par des expériences de tracage permettent d'estimer le transport résultant de aux actions combinées des divers paramètres hydrodynamiques. Ainsi, les résultats obtenus tiennent compte de toutes les forces agissantes dans le milieu, même celles qui sont

généralement négligées dans les développements théoriques ou numériques (Caillot 1979).

Cette méthode intégratrice et globale, ne permet que très rarement de mesurer certains paramètres spécifiques tels la vitesse d'entraînement (τ_*) ou le coefficient de rugosité des fonds (k_s). Par contre certaines expériences très ponctuelles permettent de montrer le rôle des figures sédimentaires dans le transport. Ces expériences précises (Vernon, 1966; Long 1977) ont pu mettre en évidence la non uniformité du transport au niveau du fond et elles ouvrent la voie à l'utilisation de modèles de diffusion appliqués à partir de l'étalement des traceurs afin d'apprécier l'uniformité et l'homogénéité du fond marin.

Ce rapport ne constitue pas une revue exhaustive de toute la bibliographie existante sur ce type d'étude. Il prétend pouvoir analyser les différentes techniques développées dans des milieux fluviaux estuariens ou littoraux, et d'extrapoler ces techniques au plateau continental. En effet, ces techniques ont été souvent liées de très près au développement des projets d'ingénieurs civils côtiers et donc éprouvées pour travailler en eau peu profonde. Depuis quelques années des expériences isolées, Vernon (1966), Got (1970), Longuemard (1972), Bratteland et Brunn (1974), Caillot et al. (1975), ont eu lieu par des profondeurs inférieures à - 20 m et souvent leurs résultats n'ont été que très descriptifs.

4.2 REVUE DES DIFFÉRENTES MÉTHODES DE TRACAGE

Les traceurs se divisent en traceurs naturels, qui

permettent d'avoir une idée globale du transport sur une longue période de temps (échelle géologique) et en traceurs artificiels développés pour obtenir une image instantanée du déplacement sédimentaire. La durée de ces expériences varie de quelques minutes (dans la zone de déferlement le long du littoral) à une année (expérience offshore en mer du Nord (Bratteland et Brunn, 1974)). Les principaux types de traceurs utilisés sont de deux catégories: les traceurs luminescents et les traceurs radioactifs. Ces autres méthodes, telle l'utilisation de la neutroactivation, de la thermoluminescence ou de sédiments magnétiques ne représentent que des essais techniques isolés qui n'ont jamais abouti au développement d'une technique scientifiquement et économiquement fiable.

a) LES TRACEURS NATURELS

Cette approche consiste à utiliser les variations de la distribution de certains marqueurs naturels le long du littoral et sur le plateau continental. Sans faire une étude détaillée de la littérature nous citerons quelques travaux ayant utilisés des minéraux lourds, des sédiments de granulométrie et de morphoscopie différentes, et la radioactivité soit naturelle, provenant des différents stocks sédimentaires, soit artificielle provenant des rejets de centrales nucléaires.

1) Minéraux Lourds

Les minéraux lourds ont souvent été utilisés comme indicateurs de provenance de stocks sédimentaires comme ce fut le cas dans l'étude de l'origine des sables des plages de Santa

Barbara (Trask, 1952), de la c[^]te de Rhode Island (McMaster, 1966) ou de Monterey (Sayles, 1966). Ils ont été utilisés pour déterminer à plus grande échelle la dynamique sédimentaire globale d'une région comme dans les cas de travaux de Judge (1970) entre Monterey et Los Angeles ou de ceux de Ross (1978) entre la Nouvelle Ecosse et le New Jersey sur le plateau et la pente continentaux américains.

Du fait de l'originalité de certains types de sédiments (minéralogie) certains auteurs ont utilisé ces stocks naturels comme des traceurs artificiels (Kidson et Carr, 1962).

ii) Taille et forme des grains

La spécification des différentes populations sédimentaires conduit à utiliser les facteurs tels la taille des grains ou la forme des particules comme traceurs naturels. En effet la distribution de ces différents stocks sédimentaires s'est effectuée en fonction de la source de ceux-ci (Friedman, 1961; Barusseau et Long, 1978; McLaren, 1981) et des agents hydrodynamiques (Friedman, 1967; Klovan, 1966; Visher, 1969; Chambero et Upchurch 1979). Récemment, Bridge (1981) a établi un modèle de la distribution granulométrique des sédiments transportés par charriage et a montré l'influence des différents paramètres sur la courbe granulométrique (cisaillement, viscosité). A partir de l'étude de la forme du grain, Ehrlich et al. (1974), Rice et al. (1976), Markovich et al. (1976), Porter et al. (1979), Ehrlich et al. (1980), Brown et al. (1980), Hudson et Ehrlich (1980) et Clark et Osborne (1982) démontrent que les quartz détritiques peuvent être utilisés comme des traceurs

naturels. En effet, une analyse des distances entre le bord et le centre de gravité du grain (48 mesures) montre que la forme initiale du grain correspond aux vingt premières harmoniques d'une série de Fourier. Or chaque population sédimentaire est représentée par une image particulière d'une harmonique, ainsi pour une population sédimentaire de même taille granulométrique, il est possible de différencier des stocks sédimentaires qui ont des histoires géologiques différentes comme celle des paléochenaux au niveau du plateau continental des rivières de Caroline du Sud (Brown et al., 1980, Hudson et Ehrlich, 1980) ou du Golfe du Mexique (Markovich et al., 1976). Rice et al. (1976) met en évidence une relation existant entre l'apport sableux des rivières et la composition des plages du Sud de la Californie; Par cette même approche, Porter et al. (1979) et Clark et Osborne (1982) démontrent que l'alimentation sableuse de la plage de Monterey n'est pas uniquement due aux apports actuels de la rivière Salinas mais aussi localement à la reprise des dunes flandriennes.

iii) Radioactivité naturelle

Parallèlement aux nombreux essais nucléaires et à la mise en marche de réacteurs nucléaires dans le monde, des mesures de radioactivités artificielles dans l'environnement ont mis en évidence la possibilité d'utiliser la radioactivité naturelle comme traceur sédimentaire. Dès 1963, Huston et Byerly préconisaient l'utilisation de minéraux radioactifs pour l'étude de transport sédimentaire en Californie, et Bastin (1963) mettait en évidence la relation existant entre la lithologie du fond

marin et la radioactivité naturelle. Par la suite, Rivière (1965), Rivière et Vernhet (1966) et Minami (1965) démontraient la signification des variations de la radioactivité naturelle sur les plages de Méditerranée et au Japon. Grant Gross (1966) mis en évidence le panache sédimentaire de la rivière Columbia et Grant Gross et Nelson (1966) déterminèrent les grands axes de transport du plateau continental des états de Washington et de l'Oregon à partir des rejets provenant de la rivière Columbia. De même, Olsen et al. (1980) montrèrent la dynamique sédimentaire (transport et accumulation) de Barnegat Bay (New Jersey).

Conjointement au développement de cette technique, Kamel et Johnson (1963) et Tashjian et al. (1964) préconisèrent l'utilisation du thorium comme traceur radioactif. Néanmoins cette méthode fut très vite abandonnée car le minerai radioactif comme les différents minéraux lourds a une densité beaucoup trop élevée et ne peut en aucun cas simuler le transport sédimentaire des sables quartzeux.

iv) Conclusion

L'utilisation des matériaux naturels permet de déterminer les grands axes de transport sous les conditions hydrodynamiques actuelles mais ne permet pas de tracer le transport dans une zone délimitée. Si le traceur est très peu onéreux, l'analyse des échantillons est souvent longue et fastidieuse et ne permet que dans très peu de cas des analyses in situ, sauf dans le cas des mesures de radioactivités naturelles.

Ces traceurs seront donc utilisés pour déterminer à l'échelle géologique les axes de mise en place des placers

métalifères. À cet égard des mesures très précises de la distribution de la radioactivité naturelle ont permis de cartographier le Bristol Channel (Miller et Symons, 1973), la baie de Banyuls (Gaucher et al., 1974), le plateau continental pyrénéo-catalan (Got, 1971; 1974) et les placers d'Ilménite au large des côtes du Sénégal (Thorn et al., 1973). Mais en aucun cas ces types de traceurs ne peuvent être utilisés pour déterminer les déplacements sédimentaires actuels.

b) TRACEURS ARTIFICIELS

À l'inverse des traceurs naturels qui font partie du milieu et qui réagissent en fonction des conditions hydrodynamiques qui les ont mis en place, le traceur artificiel est rapporté à l'environnement. Ceci implique que l'emploi de ce type de traceur pour simuler le transport sédimentaire doit s'effectuer en respectant les conditions hydrodynamiques du milieu. En particulier le traceur doit réagir de manière identique aux sédiments qui constituent le substrat, et pour cela une expérience de mesures de transport par charriage ne pourra donner des résultats valables que si les conditions de bon mélange tel que défini par Courtois (1964) et par Courtois et Sauzay (1970) sont respectées.

Les critères régissant le choix d'un traceur ont été définis par Nelson et Coakley (1974). Ces auteurs estiment que:

- 1) Le traceur doit être différent des matériaux constituant le milieu ambiant, être résistant et stable.
- 2) Il doit avoir les mêmes propriétés hydrodynamiques et mécaniques que les sédiments environnants.

- 3) Il doit être détectable en faible concentration afin de diminuer au maximum la quantité de matériel à utiliser.
- 4) Il doit pouvoir être temporaire afin de pouvoir répéter d'autres expériences dans le même milieu sans se soucier d'une contamination des sédiments. Mais corrélativement son mode de décroissance ou d'usure doit être parfaitement connu.
- 5) Il doit être d'un coût modéré.
- 6) Il doit être non toxique tant pour l'homme que pour l'environnement aquatique.

Au niveau de l'interprétation des données, deux approches différentes et complémentaires, sont utilisées dans l'emploi des traceurs artificiels, elles correspondent à l'obtention de deux niveaux de résultats différents:

- Les études qualitatives qui se contentent d'interpréter les mouvements du traceur par l'étude des variations de la forme des courbes d'iso-concentration des grains retrouvés par unité de surface.

- Les études quantitatives qui ont pour but de déterminer globalement la quantité de matériel mis en mouvement lors du déplacement sédimentaire sous l'effet des différents agents hydrodynamiques. Cette deuxième approche est celle qu'il faut de plus en plus privilégier car elle permettra d'obtenir des mesures réelles de déplacement sédimentaire et donc de pouvoir contrôler des modèles physiques ou mathématiques (numériques) qui ont été élaborés à partir de données physiques.

Avant d'aborder de manière spécifique l'étude des principaux traceurs artificiels utilisés en dynamique sédimentaire, c'est-à-

dire les luminescents ou fluorescents, radioactifs, magnétiques ou obtenus par neutro-activation, il est essentiel de définir de manière générale les différents aspects méthodologiques communs qui sont: le marquage du sédiment, l'injection et la détection du traceur et l'interprétation des données. Pour chacune de ces étapes une évaluation des différentes méthodes sera faite afin de déterminer celles qui peuvent être retenues pour l'utilisation de traceurs sur le plateau continental.

1) Le marquage des sédiments

Le marquage des particules à injecter dans le milieu doit toujours être envisagé en fonction des détections futures. Le traceur doit se distinguer aisément du sédiment naturel. Mais les procédés de marquage ne doivent pas altérer les propriétés mécaniques et hydrodynamiques du sédiment.

Trois approches sont utilisées pour fabriquer un traceur sédimentaire: le recouvrement de surface des particules provenant du site d'expérience, la création d'une particule artificielle dont le traceur est inclus dans la particule et l'injection de produit marqué dans les inclusions des minéraux formant le sédiment de base (xénonation ou kryptonation). D'autres approches existent dans le cas des marquages des sédiments fins inférieurs à 4 phi et des sédiments de la taille des galets, mais seuls les sédiments sableux sont considérés ici (Tableau I).

La troisième approche est utilisée dans les cas des traceurs radioactifs. Elle a été développée par l'Oak Ridge National Laboratory (Fig. 4.1) suivant la méthode préconisée par Carder (1966). Cette méthode consiste à faire diffuser à haute

TABLEAU I

Les différentes méthodes de marquage radioactif et leurs applications. Adapté d'après Tola (1982).

METHOD	DEFINITION	LABELLED MATERIALS	DIAMETER	RADIOACTIVE γ ISOTOPES	APPLICATIONS
INCORPORATION	INSERTION of RADIOACTIVE METAL WIRE into a drill whole which is sealed afterwards with heat-hardening resine.	- PEBBLES - GLASS + ARTIFICIAL materials	> 2 cm	¹⁸² Ta	- Transport of Pebbly by Mountain Streams - Velocity measures in two and three phase hydraulic models
BULK labelling by IRRADIATION	INCORPORATION of an (n,γ) ACTIVABLE element to molten GLASS which is then crushed to the size of the natural sediment concerned and IRRADIATED in a nuclear reactor	GLASS, for SAND SIMULATION	40 μm - 200 μm	¹⁹⁸ Au ¹⁴⁷ Nd ⁵¹ Cr ¹⁹² Ir ¹⁸² Ta ⁴⁶ Sc	Studies on BED-LOAD Transport of SAND
SURFACE labelling by DEPOSITION	DEPOSITION of Radio-active Isotope on the SURFACE of the grains by CHEMICAL treatment	- SAND - PELITIC sedi-ments (SILT, CLAY, MUD) - ARTIFICIAL materials (Polystyrène, Bakélite, Nylon Fibres)	60 μm - 200 μm < 40 μm	¹⁹⁸ Au ¹⁹² Ir ⁵¹ Cr ⁴⁶ Sc ¹¹³ In	- Studies on BED-LOAD Transport of SAND - Studies on Trans- port of SUSPENDEd Sediments - Hydraulic Scale Models and Channels

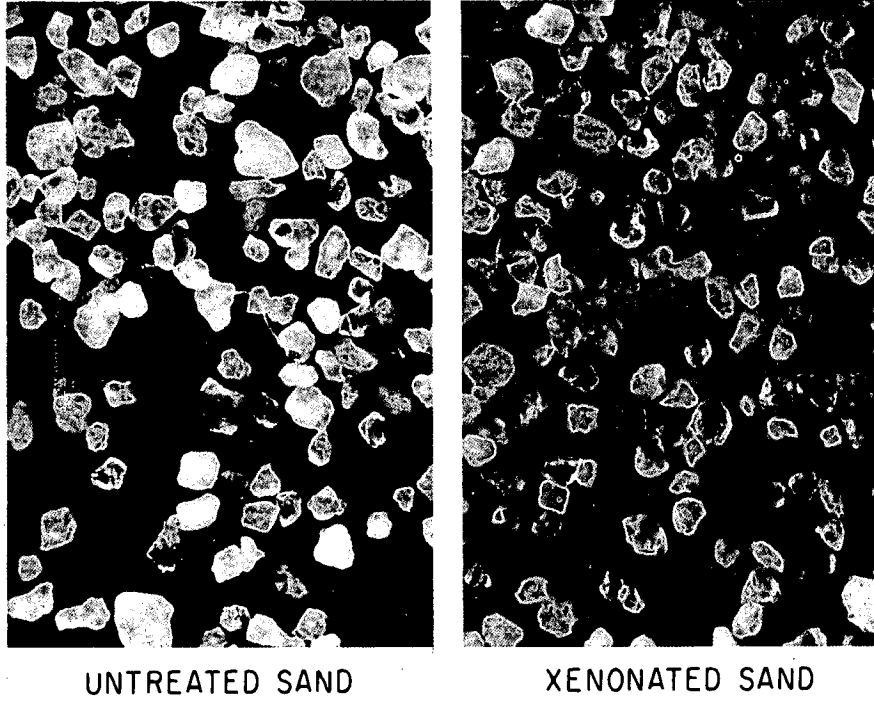

Fig. 4.1 Comparison of xenonated sand with untreated sand from the same area, mean size 2.0 phi (0.25 mm) (d'apres Duane et Judge, 1969).

température et haute pression le krypton radioactif (Kr-85) dans la particule (généralement du Quartz). La pénétration maximum du krypton dans le solide est de 0.1 à 10 μm . Cette opération forme un nouveau matériel qui est stable à température ambiante. Une approche analogue peut être utilisée pour le Xe-133 (Duane et Judge, 1969 et Airee et al., 1969 in Duane, 1970). La résistance à l'abrasion et au lavage superficiel est bonne, les pertes s'élevant respectivement à 3.5, 4.8 et 5.52% après 28, 75 et 219.5 h de lavage et à 4.4, 5.65 et 6.3% après des tests combinés de 28, 75 et 219.5 h de lavage et d'érosion. Les auteurs précisent que ces pertes sont identiques à celles obtenues à partir de revêtements de surface de solutions de Ba-La140 et de Cr51 (perte de 1% par lavage et 4% par abrasion). Le problème de cette méthode ne réside donc pas dans la qualité du marquage mais plutôt dans la difficulté à incorporer au support sédimentaire une quantité suffisante de traceur, aussi dès les deuxièmes séries de tests le programme RIST (Radio-isotopic Sand Tracer Study) a opté pour un traceur réparti en surface (Duane, 1970).

Le marquage en surface est la technique la plus utilisée pour les traceurs fluorescents et est souvent utilisé pour les traceurs radioactifs. Lean et Crickmore (1963) établissent une étude comparative entre les deux systèmes de marquage au point de vue hydrodynamique. Ils mentionnent qu'après un certain temps (32 h) une ségrégation du traceur s'effectue dans les secteurs rapprochés de la zone d'immersion (20 premiers mètres) alors que dans les secteurs plus éloignés les deux traceurs possèdent le même comportement.

Cette technique de marquage consiste à recouvrir les particules sédimentaires prélevées sur le site d'injection, d'une fine pellicule de colorant ou de substance radioactive. Ce procédé est très élégant car il conserve la morphologie des grains, néanmoins il change très légèrement le diamètre moyen (de l'épaisseur du revêtement) et il change le coefficient de rugosité du grain en obstruant les petites aspérités qui forment la surface du grain. Ces deux inconvénients n'altèrent en fait que très peu les qualités hydrodynamiques des grains. L'inconvénient majeur de cette technique provient de deux facteurs:

- l'abrasion des grains durant le transport affecte directement le recouvrement superficiel et donc la quantité de traceur qui sera détectée plus tard. Une perte importante d'information pourrait en résulter car les fines particules arrachées à la surface du grain migrent plus vite que les grains eux-mêmes. Elles peuvent ainsi créer artificiellement une extension du nuage marqué et donc une sur-évaluation du transport sédimentaire.

- le recouvrement et par conséquent la quantité de traceur détecté est proportionnelle non pas à la masse des particules mais à la surface des particules. Nelson et Coakley (1974) montrent que pour des particules sphériques la quantité de traceur (A) utilisée par unité de masse par rapport à la masse de la particule (m) est

$$\frac{A}{m} = \frac{K}{\rho_s} \frac{4\pi r^2}{\frac{4}{3}\pi r^3} = \frac{3K}{\rho_s r}$$

où r est le rayon de la particule, K la quantité de traceur par unité de surface, et ρ_s la densité de la particule.

Pour ces raisons, ce procédé donne beaucoup plus de poids aux petites particules qu'aux grosses. Ainsi, en première approximation, en estimant que les petites particules migrent plus vite que les grosses, cette méthode surevalue le transport comme dans le cas, à un moindre degré, d'une érosion du revêtement de surface. Pour ces raisons il est impossible d'utiliser des sédiments naturels pour réaliser un marquage proportionnel à la masse des sédiments.

Le marquage à partir d'éléments artificiels respecte le rapport quantité de marqueur par masse de sédiment marqué. Ces sédiments artificiels sont utilisés pour tous les types de marqueurs. Ils sont généralement disponibles sur le marché ainsi pour les marqueurs luminescents, ils existent sous forme de verre (Nelson et Coakley, 1974; Caillot et al., 1977), en couleur jaune seulement, et sous forme de résines commerciales. Dans les deux cas le coût est élevé étant donné la quantité de traceur à utiliser (Voir la section échantillonnage). Dans le cas des traceurs radioactifs de nombreux verres existent sur le marché, Caillot (1970); la composition de quelques verres est donnée dans le Tableau II. Ces verres sont broyés à la grosseur du sédiment du site expérimental et généralement l'intervalle de taille choisi représente la partie centrale de la courbe de distribution granulométrique afin de ne pas augmenter la complexité de l'interprétation de la dispersion des grains. En effet, durant le transport, un tirage granulométrique se produira et les plus petites particules migreront plus loin que les grosses. Ceci pourrait entraîner une dispersion plus grande du traceur et

TABLEAU II

Composition de divers verres en vue de marquage radioactif adapté d'après Caillot (1970).

	VERRES A			
	Iridium*	Or*	Chrome*	Tantale*
SiO ₂	48%	50.5%	48%	40%
Al ₂ O ₃	19	20	22	12
CaO	17	18	14	13
TiO ₂	5	5.25	5	3
MgO	-	6.25	6	5.5
K ₂ O	5	-	-	5
BaO	-	-	5	6.5
Ir	0.25-0.30	-	-	-
Au	-	0.04-0.5	-	-
Cr	-	-	3	-
Ta ₂ O ₅	-	-	-	15

conduir à surestimer le transport sédimentaire. Le coût du verre radioactif est élevé mais, utilisé en petite quantité, il se compare au coût de fabrication de grande quantité de traceurs luminescents obtenus par marquage en surface. Dans des expériences demandant une tonne de traceur luminescent, l'utilisation de 1 kg de verre est suffisant et le coût sera du quart.

ii) Injection

Après avoir été préparé, le traceur doit être injecté dans le milieu, pour cela différentes techniques sont employées; elles sont adaptées, au type de traceur utilisé et à la quantité de matériel à injecter.

Dans tous les cas le traceur doit le moins possible perturber le milieu. L'utilisation de grandes quantités de traceurs modifiera la morphologie du fond marin en créant une déformation du fond qui ne sera pas en équilibre avec le milieu. Par conséquent, durant les premiers instants de l'expérience, le mouvement observé des traceurs sera dû uniquement à l'érosion de cet obstacle artificiel. Ce problème est très important car sur le plateau continental seules les vagues de tempêtes remanient les sédiments et il est probable alors qu'il faudra plusieurs tempêtes pour réaliser un bon mélange du traceur dans les sédiments. Courtois et Sauzay (1966) puis Alquier et al. (1970) ont défini la notion de bon mélange en analysant les vitesses débitantes par rapport à la vitesse du centre de gravité. Les conditions de bon mélange sont atteintes lorsque:

$$\int_0^T C dt = C^{ste}$$

quel que soit le lieu d'expérience. Dans cette équation, C est la concentration en masse du traceur par unité de volume au temps t, et l'intervalle [0,T] est choisi de telle sorte que le nuage de traceur passe entièrement dans la section de mesure pendant cet intervalle de temps. Ainsi, après un régime transitoire, durant lequel les caractéristiques du phénomène dépendent des conditions initiales de l'injection, se crée un régime permanent, stable ou instable, qui ne dépend plus des conditions initiales mais uniquement des conditions du milieu (facteurs hydrodynamiques) qui définissent le débit solide.

Ayant analysé la quantité de traceur à immerger, analysons la manière d'immerger. Seules seront présentées les principales techniques utilisées tant dans la manière que dans le moyen d'immerger les traceurs.

Le traceur peut être immergé soit à partir de sacs en plastique solubles (Schulz et Pillot, 1965; Duane, 1970; Ingle et Gorsline, 1973), soit à partir de contenant versé par un plongeur (Vernon, 1966), soit à partir d'un système d'injection (Crickmore et Lean, 1962; Crickmore, 1964; Duane et Judge, 1969; Durham et Goble, 1977), soit à partir d'un système d'immersion (Sauzay, 1968; Caillot, 1979; Tola, 1982; Long et Drapeau, 1983) (Fig. 4.2) qui sera ouvert au fond ou au-dessus du fond.

Le mode d'injection peut se faire soit sous forme d'une ligne, à condition que le transport sédimentaire soit uniforme (Duane, 1970), soit ponctuellement lorsque le sédiment se déplace

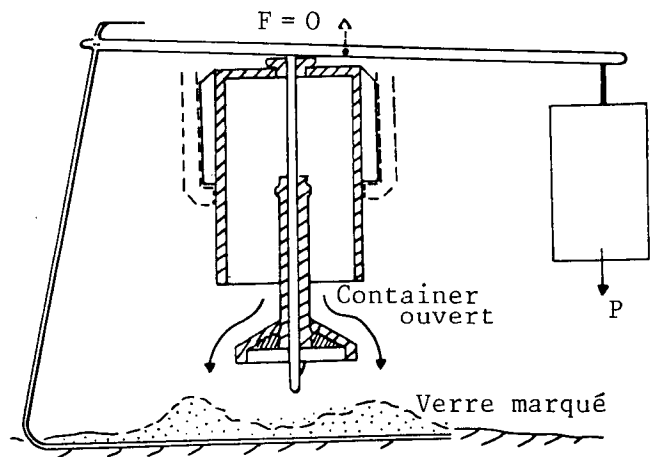
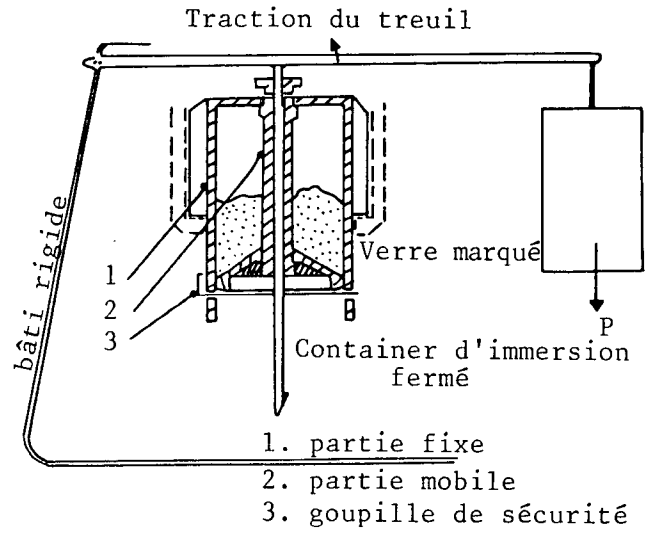
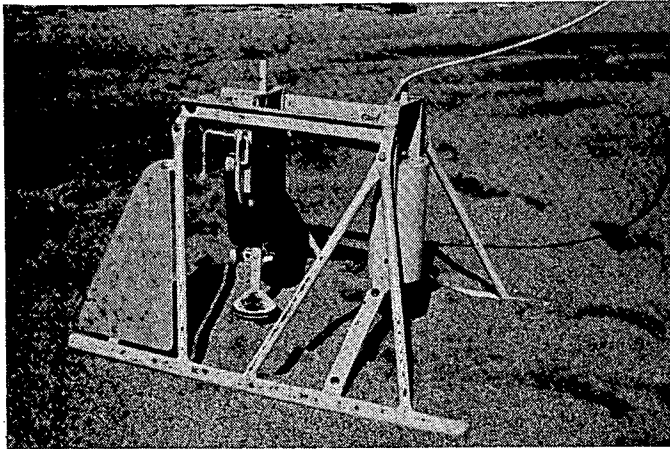

Fig. 4.2 Système d'immersion du traceur radioactif d'après la méthode proposée par Sausay (1968).

très vite (Courtois, 1964), soit encore sous forme d'un nuage de quelques dizaines de m^2 dans le cas d'un transport faible ou épisodique. Cette dernière solution, préconisée par Caillot (1979) et Tola (1982) semble être la plus adaptée aux études profondes car les chances de détecter le nuage sont beaucoup plus grandes. Des immersions ponctuelles réalisées par Vernon (1966) et Cook (1966) en Californie ou par Bratteland et Brunn (1974) en Mer du Nord et Longuemard (1974) dans l'océan Atlantique, nécessitent des expériences très ponctuelles, dont le site est repéré de manière très précise. L'échantillonnage s'effectue soit en plongée en ce qui concerne les trois premiers auteurs, soit à partir d'une station fixe dans le cas du dernier. De telles études risquent de devenir très aléatoires s'il advient un important remaniement du fond après une tempête majeure car la dispersion du traceur sera alors beaucoup trop importante pour être échantillonnée dans une grille prédéterminée si restreinte.

iii) Les Detections

L'échantillonnage du nuage de traceurs constitue la partie la plus délicate d'une expérience car elle conditionne la qualité de l'information recueillie. Si en rivière le plan d'échantillonnage est relativement facile à établir car le seul agent hydrodynamique qui agit sur lui est constitué par un courant unidirectionnel, en mer la grille devient plus complexe et le nombre de prélèvements à effectuer est plus grand. En effet, l'opérateur ne peut prévoir la direction du transport.

La quantité de traceur à injecter et le pas d'échantillonnage sont donc liés ils dépendent de la dispersion

spatiale du traceur, de sa profondeur d'enfouissement et du mode d'échantillonnage (Tola, 1982). De Vries (1966) montre dans un calcul théorique du nombre d'échantillons à prélever, que l'erreur relative dans les mesures de concentration est inversement proportionnelle à la racine carrée du nombre de grains marqués dans l'échantillon. Il conclut qu'il faut un minimum de 100 particules marquées par échantillon prélevé pour avoir une erreur de seulement 10%. De même Courtois et Sauzay (1970) démontre en fonction du type de détection que la quantité de traceurs utilisée doit varier par un facteur 100.

Quels sont ces différents types d'échantillonnage?

L'échantillonnage point par point: Ce mode d'échantillonnage est utilisé surtout dans le cas de l'emploi de traceurs luminescents, thermoluminescents ou par neutro-activation. Il consiste à prélever des échantillons soit sur des plaques enduites de graisse en plongée (Ingle, 1962; Vernon, 1966; Ingle et Grosline, 1973), soit à l'aide de petites bennes de 187.5 cm^3 (Inman et al., 1980; Gable, 1981), soit encore par carottages (Inman et al., 1980) (Fig. 4.3). Le plan de prélèvement est adapté à la présomption des directions de transport sédimentaire, il est soit en étoile (Greenwood, 1979; Gillie, 1983) soit sous forme d'une grille constituée de plusieurs radiales (Ingle, 1962, 1966; Inman et al., 1980). Ces différentes techniques sous-entendent un nombre élevé d'échantillons à analyser. Nelson et Coakley (1974) estiment qu'il faut 100 à 200 échantillons au minimum par détection. De plus, cette technique sous-entend que la grille d'échantillonnage soit parfaitement repérée pour

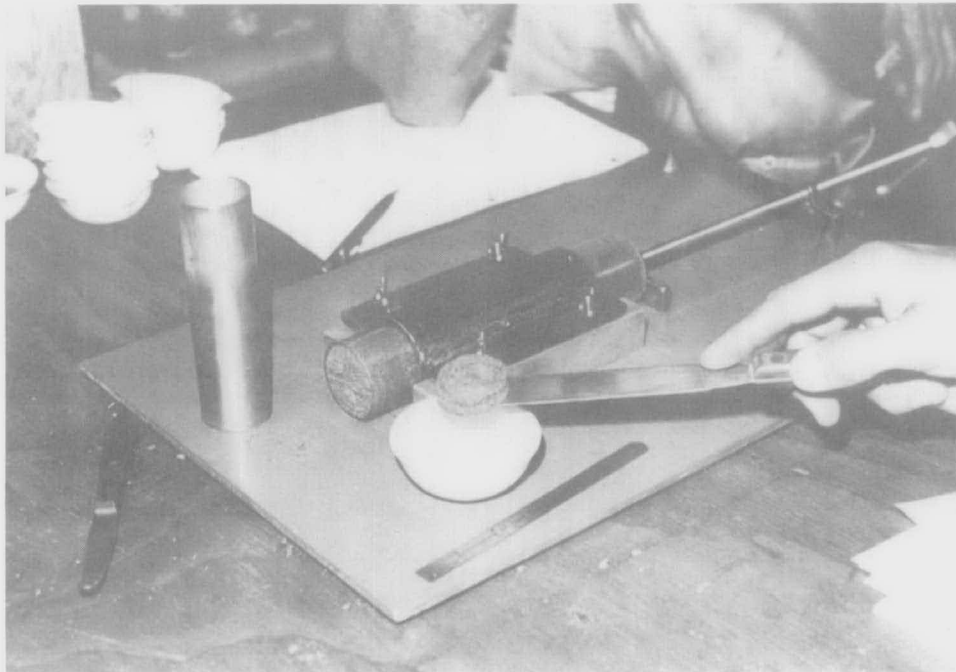

Fig. 4.3 Méthodologie de prélèvements de carottages dans le cadre d'expérience de tracage. (d'après Inman et al., 1980).

effectuer des analyses soit temporelles soit spatiales telles que définies par Inman et al., 1980. De telles expériences ne peuvent être conduites que sur des sites intertidaux ou le long de plages d'accès aisés. Généralement, les échantillons ne seront analysés qu'après un traitement parfois long et fastidieux en laboratoire ce qui implique qu'il n'y a aucun contrôle sur le bateau pour guider la détection s'il advenait un changement de direction de transport des sédiments. Une méthode sans contrôle de terrain doit être proscrite pour travailler sur le plateau continental.

Détection statique: La détection statique telle que définie par Courtois et Sauzay (1970) et Nelson et Coakley (1974) est surtout utilisée dans le cas de l'emploi de traceurs radioactifs. Elle a été utilisée en Australie par Campbell (1963, 1964), Campbell et Seatonberry (1967), en Yougoslavie par Vukmirovic et al., (1964), au Canada par Durhan et Gable (1977). Du fait de la faible couverture analysée par chaque senseur cette méthode demande l'utilisation d'une quantité de traceurs très supérieure à une détection dynamique (facteur 10). D'autre part elle ne permet pas de changer la grille d'échantillonnage et donc elle assume a priori une direction de transport. Cette méthode qui a été développée pour des régions peu profondes est intéressante pour mettre en évidence l'évolution temporelle du traceur en un point, elle devrait permettre de calculer le rôle des figures sédimentaires dans le transport par charriage. Néanmoins elle semble très peu pratique au niveau du plateau continental dans sa conception primitive. Longuemard (1974) a développé une grille

(Fig. 4.4) autonome de détection munie de 36 détecteurs (Geiger Muller) de 17 m d'envergure. Ce système expérimental n'a que très peu fonctionné par une profondeur de 28 m mais il semble que pour le plateau continental, si le transport sédimentaire est faible cette station autonome puisse avoir un avenir (Fig. 4.4).

Détection dynamique: Durant une détection dynamique, le détecteur est monté sur un traineau ou un chariot et est traité sur toute la zone d'étude. Durant ce périple le détecteur couvre une très grande surface et par la même occasion a la possibilité de détecter une infinité de grains marqués. Du fait de la présence de systèmes d'acquisition de données très compactes ce mode de détection est le plus couramment employé dans le cas de l'utilisation de traceurs radioactifs (Duane, 1969; Duane et Judge, 1970; Sauzay, 1968; Courtois et Monaco, 1966; Lavelle et al., 1978; Heathershaw, 1980, 1981; Long et Drapeau, 1983; Drapeau et Long, 1984). Case et al. (1971) estiment que 2% de tout le traceur déposé sur le fond peut être détecté en une heure sur une surface de 300 x 600 m ce qui correspondrait à un équivalent de 50,000 échantillons prélevés avec une benne Shipek (Nelson et Coakley, 1974). La précision de cette méthode est directement proportionnelle aux nombres de sections à travers le nuage et permet de faire évoluer la marche du navire en fonction des résultats. Les résultats sont collectés en continu, à raison généralement d'une valeur à la seconde. Ils sont traités partiellement sur le navire et les données sortent sous formes graphique et analogique. Des cartes d'isoconcentrations peuvent être obtenues sur le bateau après traitement des informations par un micro-ordinateur. Cette approche est donc la plus séduisante

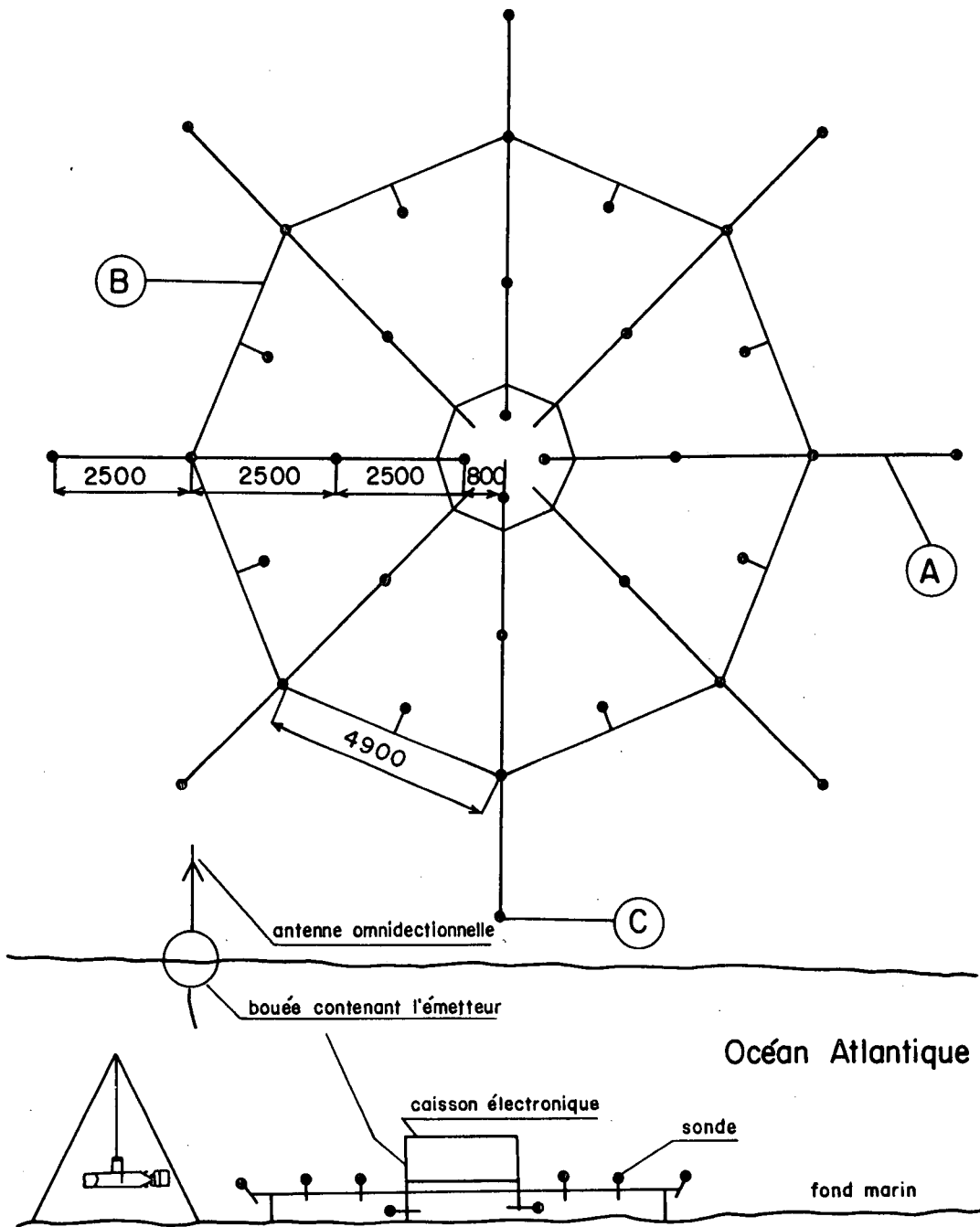

Fig. 4.4 Système automatique d'acquisition de données. Système utilisé sur le plateau continental par Longuevard (1974).

pour travailler à l'échelle du plateau continental, seul le problème de la position du traineau sur le fond par rapport au navire reste posé par grande profondeur. Lavelle et al. (1978) estiment qu'il faut une longueur de câble de 107 m pour travailler à -21 m, Duane et Judge (1969) calculent qu'un câble de 60 m (200') permet de détecter par une vitesse de 4 noeuds à une profondeur de 25 m (80'). Si la vitesse croît à 6 noeuds la profondeur maximum sondée sera de 16 m (55'). Ces différents résultats reflètent le rôle de la forme de l'appareil de détection.

Pour leurs parts, Courtois et Sausay (1970) estiment qu'entre les trois différentes méthodes d'échantillonnage (ponctuelle, statique et dynamique) la quantité de traceur à utiliser est de l'ordre de 100/10/1. Pour cette raison, Tola (1982) et Caillot (1979) considèrent que l'utilisation de 500 à 1000 g de sédiments radioactifs est suffisante pour mener à bien des expériences de tracage en mode dynamique alors que Bratteland et Bruun (1974) emploient 90 kg de traceurs dans le cas d'un échantillonnage ponctuel.

iv) Interprétation des données

Le dépouillement et l'interprétation des données dépendent du mode opératoire suivi précédemment. Elles font généralement toutes appel à des détecteurs électroniques du matériel marqué. Le signal est généralement traduit en photons (Tableau III).

Les études qualitatives: Ces études consistent à tracer les lignes d'isoconcentrations du marqueur et à déterminer visuellement les axes de transport. Or ces contours sont souvent très approximatifs étant donné l'espace existant entre les différents prélèvements. Vernon (1966) montre que le transit sédimentaire est directement affecté par les figures sédimentaires, or les grilles d'échantillonnage déterminées a priori ne permettent pas d'apprécier les positions de ces figures. La plupart des auteurs ayant entrepris des expériences de marquages de sédiments se sont contentés de ce type de résultats car le pourcentage de grains marqués comptés par rapport aux grains injectés est si faible qu'aucun calcul ne peut statistiquement être entrepris. Ceci est particulièrement le cas dans la grande majorité des expériences utilisant des traceurs luminescents. Par exemple McLaren et Buckingham (1983) estiment que 90% de la peinture utilisée pour marquer les grains injectés est perdue après 48 h et que 50% de celle restante l'est au bout de 15 jours lors d'une expérience effectuée dans le delta du Fraser.

Les études quantitatives: Ces études ont été entreprises à partir des expériences utilisant des traceurs radioactifs. Crickmore et Lean (1962a et b, 1963) ont été les premiers à

TABLEAU III

Méthodes de marquage des sédiments d'après Nelson et Coakley (1973).

MARQUEUR	NATURE DU SIGNAL DÉTECTÉ	NATURE DU MARQUAGE	« IN SITU » DÉTECTION POSSIBLE?
1. Radionucléides	photons, (MeV)	actif	Oui
2. Peintures luminescentes	photons, (eV)	activable	Oui
3. Chimique: détecté par			
a) Absorption atomique	photons, (eV)	activable	Non
b) Neutro-activation	photons, (MeV)	activable	Non
c) Fluorescence R.X	photons, (eV)	activable	Non
4. Thermoluminescence	photons, (eV)	activable	Non
5. Radiophotoluminescence	photons, (eV)	activable	Possible

développer des méthodes intégratrices puis, Courtois (1966, 1970), Sauzay (1968) et Courtois et Sauzay (1965, 1966) ont défini la méthode du bilan des taux de comptage. Cette méthode a été raffinée par Courtois et Monaco (1968, 1969), Courtois et Sauzay (1970) en définissant la quantité optimale de traceur à utiliser. Depuis de nombreux auteurs l'utilisent pour définir le transport par charriage (Caillot et al., 1975; Long 1977; Caillot, 1979; Heathershaw, 1981; Duane et James, 1980; Lees, 1983).

Cette méthode reprise par Caillot (1979) a pour but de déterminer le débit de charriage à travers une section orthogonale à la direction résultante.

$$q = \rho \cdot L_t \cdot V_m \cdot E_m \quad (4.1)$$

ou q est le débit de charriage (tonne/jour),

ρ la masse volumique du sédiment,

L_t la largeur du transport (mètre),

V_m la vitesse moyenne du transport (mètre/jour),

E_m l'épaisseur du transport, c'est-à-dire, la valeur moyenne de la distance entre la surface du lit et les grains radioactifs les plus enfouis.

Pour résoudre cette équation, il faut déterminer V_m et E_m pour une largeur unité $L_t = 1$ m.

Détermination de la vitesse V_m : Le nuage de particules radioactives est représenté par un réseau de courbes isochocs dont l'axe d'allongement (abscisse) est confondu avec la direction moyenne du transport. Ce nuage est caractérisé par la position du centre de gravité sur l'axe d'allongement. L'évolution du centre de gravité dans le temps obtenu par détectations successives, est calculée à partir de référence (points

d'immersion) et détermine la vitesse moyenne de transport V_m .

L'examen de la courbe de V_m en fonction du temps permet de connaître les conditions d'intégration du traceur au milieu; le traceur se mélange lentement aux sédiments naturels en "glissant" à la surface des fonds puis lorsque les conditions de "bon mélange" du traceur sont obtenues le transport est uniforme et généralement sa vitesse apparente devient plus faible.

Détermination de l'épaisseur de transport E_m : La formation de rides ou dunes hydrauliques ou la prise de carottages sont des indices de l'épaisseur de transport E_m , mais la deuxième approche n'est pas toujours techniquement ou économiquement possible (Waters et Thorn, 1975). Cette épaisseur de transport peut être estimée par la méthode du bilan des taux de comptage proposée par Sauzay (1967) et Courtois et Sauzay (1970). En effet, plus l'épaisseur du mélange est grande plus les traceurs sont enfouis et plus les rayonnements qu'ils émettent sont absorbés et diffusés. Il existe une relation entre le nombre de photons N recus par le détecteur, l'activité A introduite et l'épaisseur d'enfouissement E_m :

$$\frac{1}{\beta} \frac{\alpha}{f_0} \frac{N}{A} E = 1 - e^{-\alpha E} \quad (4.2)$$

où: α et f_0 sont les coefficients d'étalonnage pour le détecteur utilisé. f_0 correspond au rapport reliant l'activité lue (en désintégrations par seconde: cps) à l'activité de 1 μCi répartie uniformément sur une surface plane circulaire de 1 m^2 centrée sous le détecteur et enfouie sous une profondeur z de matériau naturel:

$$f = f_0 e^{-\alpha z} \quad (4.3)$$

N représente l'intégration de toutes les mesures de comptage corrigée du bruit de fond sur l'ensemble de toute la tache radioactive, il est égal à:

$$N = \iint n ds \quad (4.4)$$

où n est le nombre de mesures comptées par unité de surface et ds est l'élément de surface. A est l'activité totale immergée. β est une fonction de l'enfouissement E, connue selon la forme de la répartition de la concentration en profondeur β varie de 1.05 à 1.15 (Sauzay, 1968).

D'autres auteurs ont développé des méthodes différentes de détermination du transport sédimentaire. Ces modèles ont été réalisés tant pour les études en laboratoire (canal) que sur le terrain; ainsi De Vries (1966, 1971) propose deux modèles de diffusion pour étudier la dispersion de traceurs luminescents, et Crickmore (1967) pour celle de traceurs radioactifs en rivière. Nelson et Coakley (1974) définissent une approche globale d'après le travail de Crickmore et Lean (1962b et 1963). D'autres auteurs, Russel et al. (1963), Crickmore et Lean (1962a), Crickmore (1967) et Pilon (1965) utilisent les lois de dilution pour déterminer le transport sédimentaire. Lavelle et al. (1978) ont utilisé un modèle de diffusion dans lequel la description du nuage sédimentaire suivant deux dimensions s'énonce:

$$\frac{\partial C}{\partial t} + V_x \frac{\partial C}{\partial x} - D_x \frac{\partial^2 C}{\partial x^2} - D_y \frac{\partial^2 C}{\partial y^2} = 0 \quad (4.5)$$

où $C(x,y,t)$ représente une concentration de matériel marqué aux points x,y au temps t qui ont subi un mouvement d'advection

depuis la source.

V_x représentent l'intensité de l'advection sédimentaire.

D_x et D_y les coefficients de diffusion sédimentaire.

Pour leur part, Inman et al. (1980) ont déterminé deux approches différentes de mesures pour la zone littorale, une approche temporelle pour mesurer la vitesse du transport littoral et une approche spatiale pour déterminer le flux de matériaux transportés (Tableau IV). Ces modèles permettent d'utiliser de manière quantitative et avec une grande précision les résultats de campagnes de transports sédimentaires utilisant des marqueurs luminescents.

En conclusion, les différentes méthodes d'interprétations dépendent dans une large mesure du traceur utilisé et du type de détection réalisée. Elles conviennent généralement à des situations prédéterminées et permettent d'estimer avec une bonne précision le transport sédimentaire. La précision des résultats obtenus dépendra de la précision des mesures effectuées autour du point central de mesure. Au niveau du plateau continental, si le transport sédimentaire est faible, le nuage de sédiment marqué sera peu important et la position des échantillons ou du traineau de détection sera le problème le plus important à résoudre. Il faudrait que le positionnement du bateau soit effectué avec une précision de l'ordre du mètre et non pas de 10 m comme la donne la plupart des systèmes de positionnement. D'autre part la position de la sonde ou de la benne doit être parfaitement connue durant toutes les détections.

TABLEAU IV

Méthodes d'analyses des résultats obtenus par expériences de tracage (d'après Inman et al. 1980).

APPROCHE TEMPORELLE		APPROCHE SPATIALE	
L'échantillonnage s'effectue à stations fixes suivant un pas régulier.		L'échantillonnage s'effectue suivant une grille pré-établie à temps fixe.	
Intervalle simple	$\begin{matrix} \cdot & & \times \\ \cdot & & \times \\ \cdot & -v_\ell \rightarrow & \times \\ \cdot & & \times \\ \cdot & & \times \end{matrix}$	$\begin{matrix} \times & \cdot & \times & \times & \times & \times \\ \times & \cdot & \times & \times & \times & \times \\ \times & \cdot & \times & \times & \times & \times \\ \times & \cdot & \times & \times & \times & \times \\ \times & \cdot & \times & \times & \times & \times \end{matrix}$	
Ligne d'injection (Li) t ₀ , y ₀	Ligne d'échantillonnage (Le) 0 ≤ t _i ≤ ∞	$\begin{matrix} \uparrow \\ \text{ligne d'injection} \cdot t_0, y_0 \\ \text{ligne d'échantillonnage} \times \quad -\infty \leq y_1 \leq \infty \end{matrix}$	
y _i est la distance entre Li et Le			

Conservation du traceur?

$$M = \int_0^{x_b} \int_{t_0}^{\infty} \frac{y}{x} Z_0 \bar{N} dx dt$$

$$M = \int_0^{x_b} \int_{-\infty}^{\infty} Z_0 \bar{N} dx dy$$

où: M représente la masse du traceur injecté et Z₀(x) l'épaisseur de la couche mobile

$\bar{N}(x, y, t) i$ = masse/volume

i représente un échantillonnage particulier.

Les caractéristiques de la vitesse du transport littoral sableux sont:

Le volume du flux sableux est:

$$v_\ell = \frac{1}{\sum N_i} \sum N_i \frac{y_i}{x_i}$$

$$Q_\ell = \int_0^{x_b} v_\ell Z_0(x) dx$$

La quantité de transport immergée est

$$I_\ell = Q_\ell (\rho_s - \rho) g N_0$$

4.3 LES TRACEURS LUMINESCENTS

Les traceurs luminescents ou fluorescents sont utilisés depuis longue date mais la méthode d'échantillonnage utilisée pour les détecter n'a que très rarement passé le stade de l'échantillonnage point par point. Seuls deux systèmes automatiques de mesure in situ semblent avoir été développés, le premier (Nelson et Coakley, 1974) l'a été par Kullenberg de l'Institut d'Océanographie Physique de l'Université de Copenhague. Ce procédé a été testé sur le Lac Ontario en collaboration avec le C.C.I.W. Le système se compose de deux tubes photomultiplicateurs étanches et d'une lampe ultra-violet. L'un des tubes sert de référence et l'autre compte le rayonnement émis par les grains luminescents. Actuellement aucun résultat tangible n'a été obtenu avec ce système.

Un deuxième système, développé par l'Institut de Géologie du Bassin d'Aquitaine de l'Université de Bordeaux (Caillot et al., 1977) est basé sur le même principe que précédemment mais dans son état actuel cet appareil n'est depuis 1978 qu'au stade de prototype de laboratoire, et n'a pas été utilisé sur le terrain.

Pour des expériences très ponctuelles, Vernon (1966) utilisait une caméra en plongée et obtenait ainsi la distribution du nuage sur un mètre carré par une profondeur de 30 m (Fig. 4.5).

Toutes les autres expériences utilisant des traceurs luminescents ont été conduites en utilisant l'échantillonnage suivant une grille. Si le long du littoral des expériences menées avec de relativement faibles quantités de traceurs (5 kg

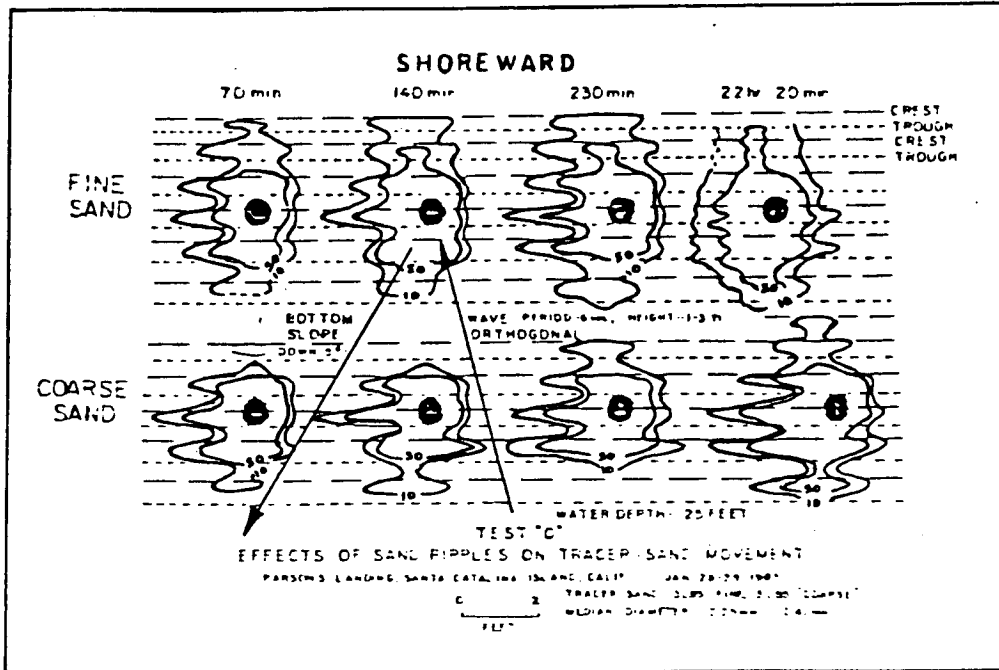

Fig. 4.5 Dispersion du traceur, par des profondeurs de 30 m. Influence des rides sedimentaires (d'après Vernon, 1966).

par point d'injection le long d'une ligne comprenant plusieurs points (5-6) dans les expériences du programme NSTS à Santa Barbara (Inman et al., 1980)), n'ont pas donné de résultats, probant, dans le delta du Fraser, 200 kg de sable marqué furent utilisés par point (McLaren et Buckingham, 1983) de même, que 90 kg de sable à Ekofisk (Bratteland et Bruun, 1974). Ce traceur est préparé selon différentes méthodes suivant la couleur recherchée. Le coût de préparation était environ de \$10./kg pour une préparation de 100 kg de traceur. Les différentes couleurs existantes sur le marché sont données au Tableau V.

TABLEAU V

Différentes peintures, lumineuses utilisées en sédimentologie (adapté d'après Nelson et Coakley, 1974).

PEINTURE	COULEUR
Anthracène	Jaune-vert
Lumogène	Rouge orangé
Rhodamine B	Rouge
Rhodamine WT	Rouge
Primuline	Bleu
Erosine	Orange
Auramine	Jaune
Victoria bleu B	Bleu
Soudan I, II et III	Rouge
Laques acryliques Day-Glo	Couleurs variées

D'autre part, certaines compagnies (Saint-Gohain en France) fabriquent des verres luminescents ($\rho = 2.65$) contenant 5% d'oxyde d'uranium (U_3O_8) qui émet sous l'action d'un éclairage ultra-violet, une coloration jaune intense. Etant donné le prix élevé de ce verre, l'utilisation d'un sédiment peint reste la solution la plus avantageuse.

L'immersion du traceur sur le plateau continental est effectuée suivant différents procédés. Jolliff (1963) ouvre un contenu au fond, Vernon (1966) utilise des sacs de plastique qui sont ouverts à l'aide d'une lame coupante opérant automatiquement au contact du fond, Stuiver et Purpura (1968) emploient des sacs solubles alors que De Vries (1973) décrit une méthode utilisant un traceur congelé, immergé sous forme de tuile qui se décongèle sur le fond. Lees (1979) a utilisé un système d'injection par tuyau pouvant injecter 0.75 tonne de sédiments marqués par 17 m de fond. (Fig. 4.6) Le traceur est répandu à 40 cm au-dessus du fond.

Le dépouillement des données est effectué en laboratoire à partir de trois techniques différentes:

- le comptage manuel dans une chambre noire, sous une lampe UV des grains luminescents. Cette approche est toujours utilisée car plus fiable que les autres (Inman et al., 1980). D'autre part, si l'échantillon est séché puis tamisé on peut discriminer les grains marqués en fonction de la taille des particules et ainsi analyser les différentes fractions séparément (Lees, 1979).

- le comptage du rayonnement luminescent à partir d'appareils automatiques développés par Teleki (1967). Cette analyseur automatique a été abandonné dans les expériences

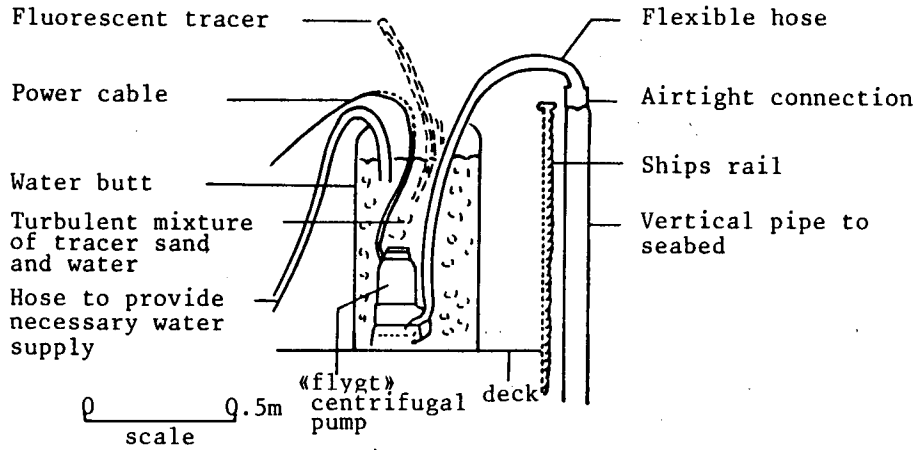

Diagram to show apparatus for injection of fluorescent tracer slurry onto seabed.

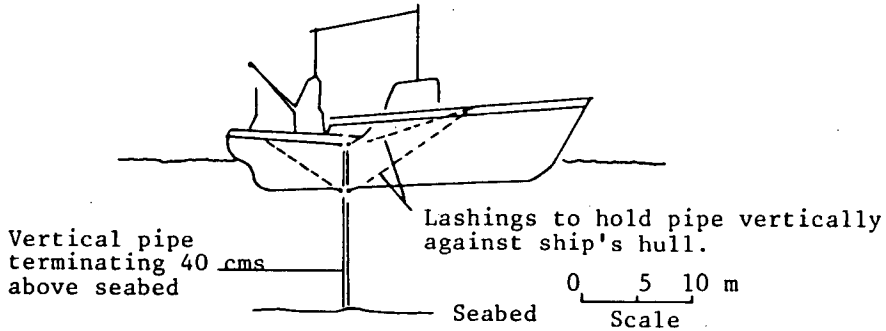

Diagram of RV «Edward Forbes» to show method of lashing pipe vertically against ship's hull.

Fig. 4.6 Systeme d'immersion de traceurs luminescents dans le cas d'une injection de grande quantite de traceur (750 kg) (d'apres Lees, 1979).

récentes malgré un comptage assez rapide d'un échantillon. S'il était très utile pour des échantillons collectés proche du point d'immersion, où la concentration de sédiment marqué est très grande, ce procédé deviendrait très lourd pour compter quelques grains et un comptage visuel serait alors plus rapide.

- l'utilisation de peintures solubles dans des solvants permet de déterminer la concentration du traceur en analysant la concentration du colorant à partir d'un colorimètre. Cette technique semble séduisante car elle permet de remettre en solution toute la peinture contenue dans un échantillon et donc de ne plus faire un comptage en surface. Actuellement il semble toutefois que cette méthode utilisée apparemment avec succès par Lees (1979) semble pouvoir n'être pas toujours un succès. McLaren et Buckingham (1983) mentionnent que le recouvrement de peinture a tendance à partir. Ils déterminent que 9% de la peinture est perdue durant les premiers 48 heures et 5% de celle restante durant les 15 jours suivants.

Ces trois différentes méthodes de dépouillement demandent un travail de laboratoire fastidieux car la quantité d'échantillons à prélever est importante (200 environ). Or les méthodes utilisant des fluorimètres portables (Yasso, 1962) ne sont pas adaptées au plateau continental car ces systèmes ne sont pas étanches. D'autre part les cellules photo-électriques et les photomultiplicateurs ne permettent pas de détecter de faible rayonnement in situ. La concentration minimum est de l'ordre de 50 grains/m². De plus l'enfouissement en profondeur ne peut être déterminé que par la prise de carottes et par un comptage

4.4 LES TRACEURS RADIOACTIFS

Les premiers travaux utilisant les traceurs radioactifs pour étudier les déplacements sédimentaires furent entrepris en 1954 (Putman et al., 1954 et Hours et al., 1955). Pendant 10 ans cette approche est restée aux mains des spécialistes en radioactivité qui ont développé des techniques de marquage (Smith et Eukins, 1957; Zakeotki, 1958; Rispal, 1962; Cambell, 1963; Gilbert et Cordiero, 1962; Petersen, 1960, 1963; Becker et Golte, 1965; Meyn, 1965; Jeanneau, 1965; Bougault, 1966; Bougault et al., 1967; Patrikeyer et Orlova, 1968; Stephens et al., 1968) d'immersion et de détection (Dolezal et al., 1965; Callesen et Otterstrom, 1961). Durant cette période l'interprétation des résultats fut limitée aux études qualitatives. Depuis 1962 les premières approches quantitatives furent développées (Crickmore et Lean, 1962a et b; Crickmore, 1964; Courtois, 1964, 1966, 1968, 1970; Courtois et Sauzay, 1965, 1966, 1970 et Sauzay, 1968). Parallèlement au développement de ces méthodes quantitatives les applications de cette technique furent de plus en plus nombreuses tant sur le plateau continental que dans les estuaires et fleuves. En 1979 l'équipe de C.E.N. Saclay avait réalisé plus de 200 immersions de traceurs (Caillot, 1979).

Les traceurs radioactifs, utilisés depuis 1955 en sédimentologie n'ont cessé de voir leur utilisation se perfectionner. Au départ, la détection du matériel radioactif se faisait point par point, puis Crickmore et Lean (1962, 1963), Hubbel et Sayre (1964), Courtois (1964) développèrent les principes des détections dynamiques tandis que Campbell (1963,

1964), Campbell et Seatonberry (1967) et Vukmirovic et al. (1964) mirent au point les principes de la détection statique (Fig. 4.7). Les systèmes d'acquisition automatique des données furent développés par Duane et Judge (1968) dans le cadre du programme RIST en collaboration avec l'Oak Ridge National Laboratory (ORNL). Ce programme a perfectionné son système de détection. Après avoir utilisé le Xe 133 avec des résultats aléatoires (Duane et Judge, 1968) l'Au 198 (Duane, 1970) puis le Ru 103 (Lavelle et al., 1978) furent utilisés pour tracer des déplacements sédimentaires dans la zone de déferlement, en estuaire ou sur le plateau continental. Nelson et Coakley (1974) mentionnent que le système qui fut conçu à l'origine selon un concept très lourd (le détecteur pesait 500 lbs) a été miniaturisé et que les dépouillements de données sont maintenant très rapides grâce à un système entièrement automatisé. Parallèlement au système développé par l'ORNL, Courtois (1964) et Sauzay (1968) développèrent un système plus compact qui s'est progressivement automatisé (Courtois, 1968; Caillot et al., 1974; Caillot, 1979 et Tola, 1982). Depuis 1975 cette technique est développée au Canada et a été utilisée dans les zones intertidales (Long, 1977; 1978), en région estuarienne (Long, 1983) et en zone infralittorale (Long et Drapeau, 1983) (Fig. 4.8).

Les isotopes utilisés sont tous des émetteurs gamma (Tableau VI). Dans le passé le phosphore 32 (émetteur beta dur) a été utilisé au Portugal mais depuis les émetteurs gamma sont préférés car leur détection est beaucoup plus précise. Les traceurs sont

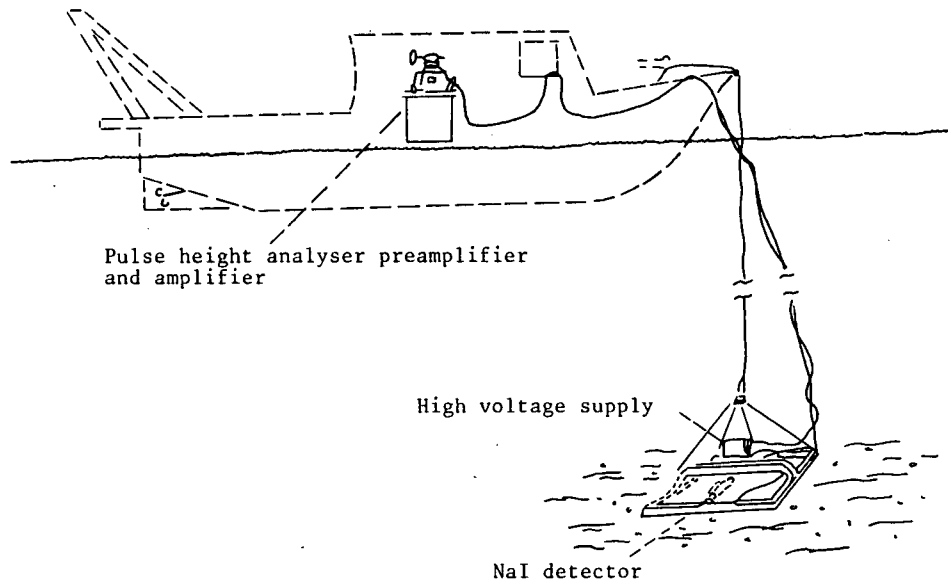

a) Détection statique (d'après Durham et Gable, 1977).

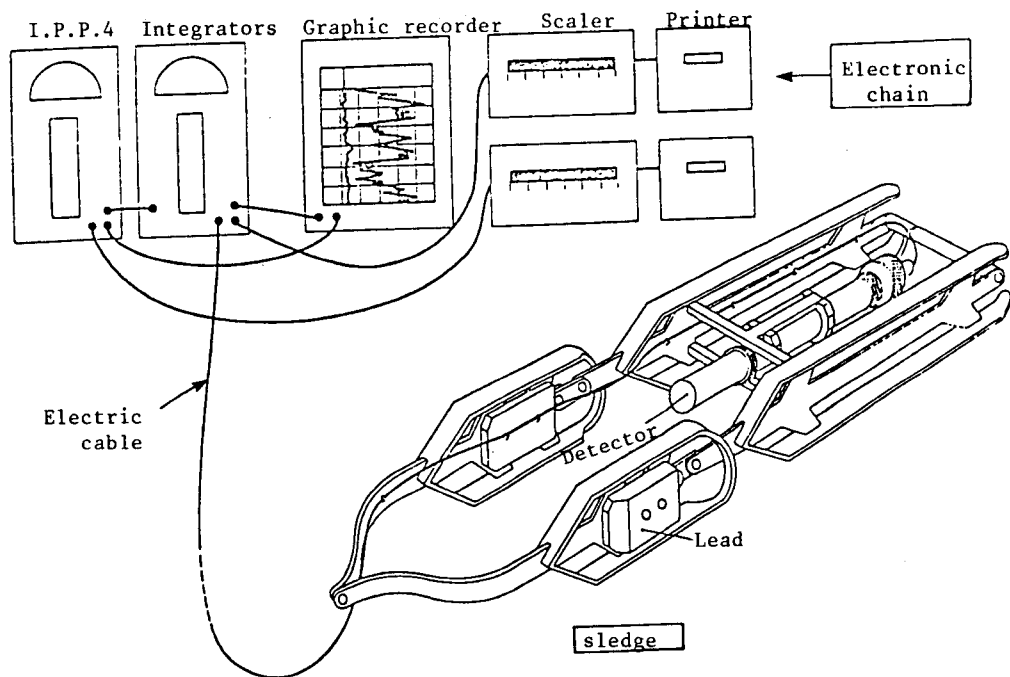

b) Détection dynamique (d'après Tola, 1982).

Fig. 4.7 Systeme d'acquisition de données.

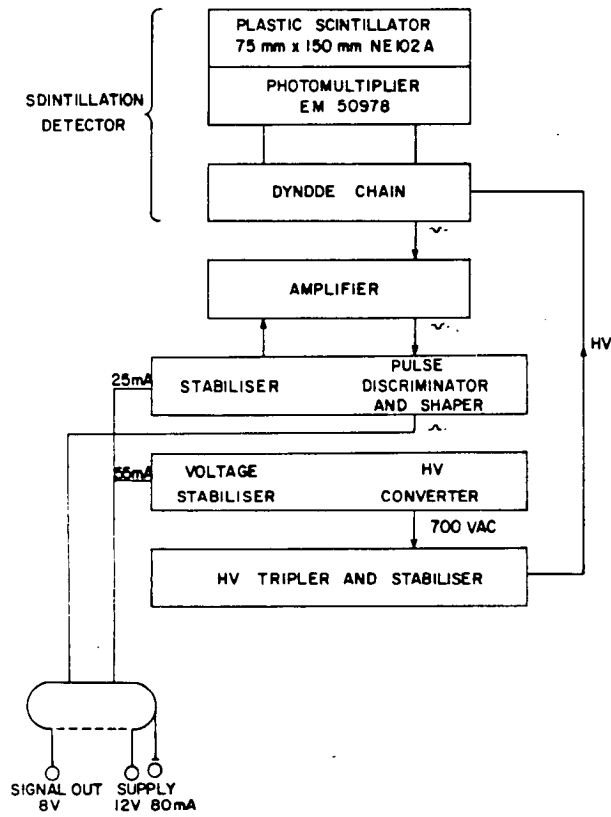

SONDE DE DETECTION (Tola, 1982)

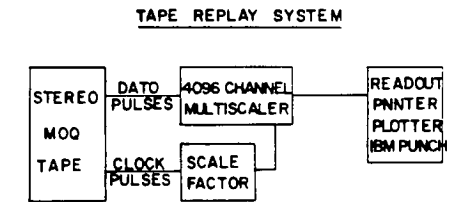
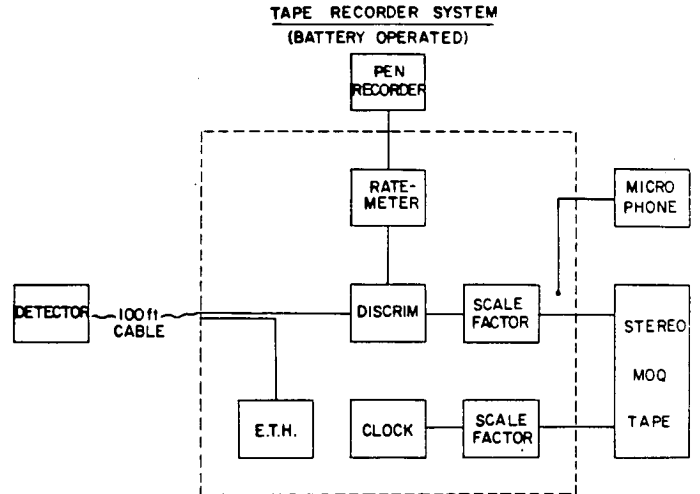

SYSTÈME FRANÇAIS (Tola, 1982)

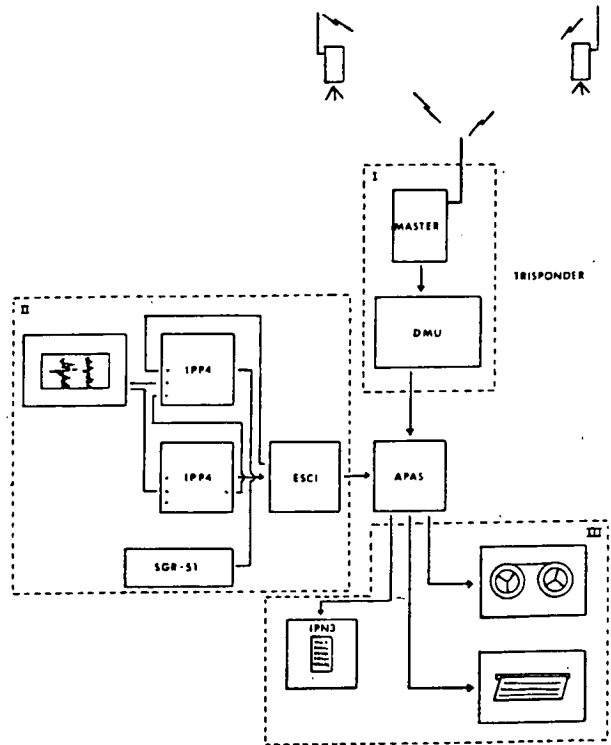

SYSTÈME CANADIEN (Long et Drapeau, 1983)

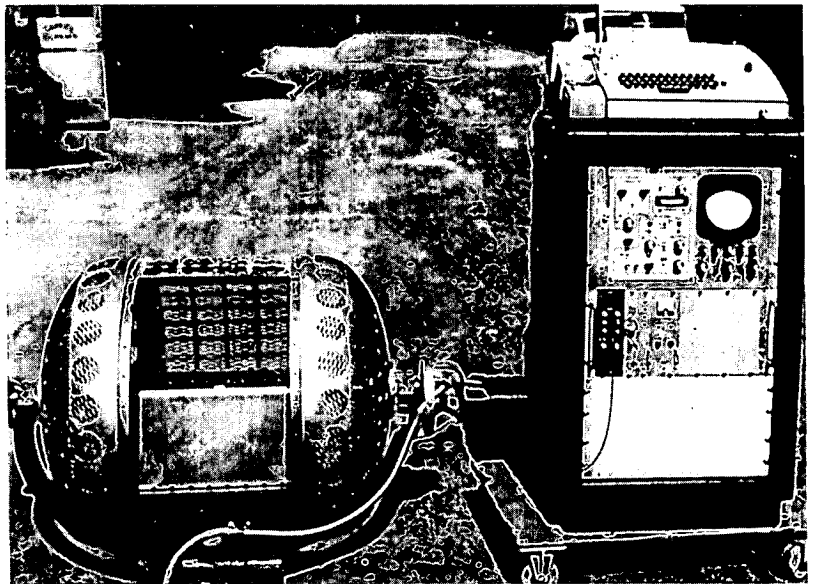

Fig. 4.8 Différents systèmes d'acquisition de données existant dans le monde.

TABLEAU VI

Liste des principaux radio-éléments utilisés en sédimentologie.

Qualité du traceur: (F) faible, (B) bon, (E) excellent.

ISOTOPES	PÉRIODES	ÉNERGIE MOYENNE DE γ EN MeV	FORME D'UTILISATION MARQUAGE	VERRE	DOMAINE D'EMPLOI EN SÉDIMENTOLOGIE
^{113}In	0.07	0.3	bakélite vases	-	Modèles hydrauliques (B)
^{76}As	1.10	0.560	surface (sable)		Mouvement des sables (F)
^{198}Au	2.7	0.412	surface	x	Mouvement des sables et argiles (E)
^{133}Xe	5.2	0.081	xenonation	-	Mouvement des sables (F)
^{147}Nd	11.1	0.260	-	x	Mouvement des sables (B)
$^{140}\text{Ba} + ^{140}\text{La}$	12.8	1.596	surface	-	Mouvement des sables (B)
^{51}Cr	27.8	0.32	-	x	Mouvement des sables et argiles (E)
^{103}Ru	39.8		surface		Mouvement des sables (E)
$^{170} + ^{181}\text{Hf}$	40 - 70	0.10 - 0.50	surface	-	Mouvement des argiles (B)
^{59}Fe	45	1.20	surface	-	Mouvement des sables (F)
^{192}Ir	74.2	0.36		x	Mouvement des sables (E)
^{46}Sc	84	1.0	surface	x	Mouvement des sables et argiles (E)
^{182}Ta	111	1.0	inclusion	x	Mouvement des galets et sables (E)
^{65}Zn	245	1.10	surface	x	Mouvement des argiles (B)
^{110}Ag	253	0.66 - 0.94	surface	x	Mouvement des sables et galets (B)

utilisés soit sous forme de revêtements de surface de sédiments naturels soit sous forme de verres activables. Ils peuvent être obtenus commercialement à partir de l'ORNL aux USA ou du CENS en France.

Ces radio-éléments ont des utilisations différentes en fonction de leur demi-vie (ou période). L'or (^{198}Au), l'arsenic (^{76}As) et le xénon (^{132}Xe) sont utilisés pour tracer des mouvements sédimentaires rapides comme ceux se produisant dans le déferlement. Les marqueurs de moyenne période ^{147}Nd , ^{51}Cr et ^{103}Ru sont utilisés pour des expériences se déroulant sur des périodes variant de 30 à 90 jours alors que ^{192}Ir et ^{46}Sc peuvent être utilisés pour des expériences de 180 à 360 jours. Généralement l'expérience peut durer quatre demi-vies du traceur. L'activité à utiliser est limitée tant au niveau de l'activité maximum par grain que pour l'activité totale afin de respecter les normes de contrôle de la Commission de Contrôle de l'Energie Atomique du Canada. Long et al. (1978) ont déterminé pour les principaux isotopes utilisés en sédimentologie les limites admissibles et recommandées d'utilisation (Fig. 4.9). Ce travail fait suite aux recommandations de Courtois et Hours (1965) et de Petersen (1965) qui avaient établi des propositions concernant les conditions particulières d'emploi des radio-éléments artificiels pour étudier les mouvements de sédiments en calculant les risques inhérents à l'utilisation des radio-isotopes. Ces limitations ne réduisent en rien l'efficacité de la méthode, Courtois et Sauzay (1970) ont déterminé la masse minimum et l'activité minimum à injecter pour mener à bien des expériences de tracage. Il apparaît que l'utilisation de 1 kg de traceur est

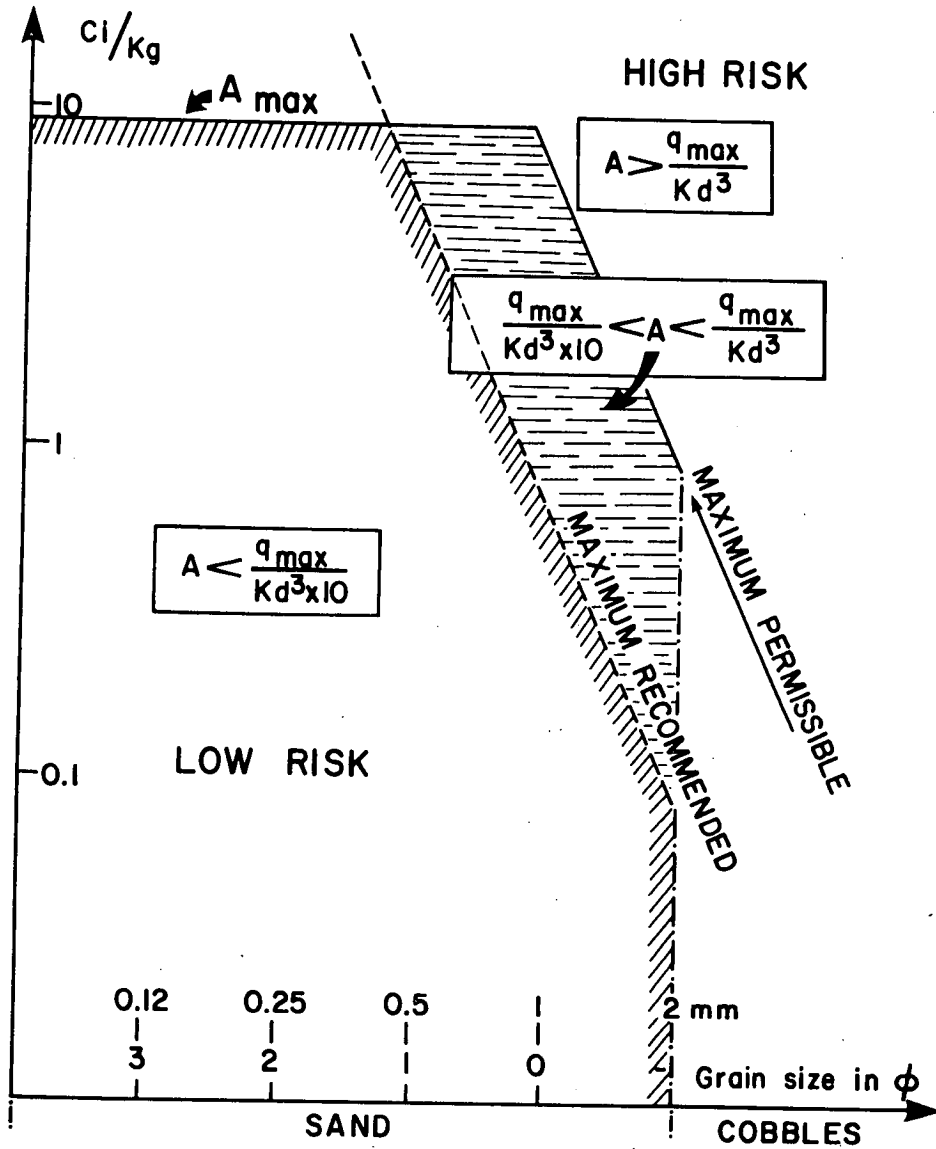

Fig. 4.9 Diagramme de détermination de l'activité permise dans l'utilisation de traçeur radioactif en dynamique sédimentaires (d'après Long et al., 1978).

suffisante et que pour des traceurs d'énergie moyenne de 360 KeV (comme ^{192}Ir) ou de 260 KeV (^{147}Nd), 2 curies ($1 \mu\text{Ci} = 37 \times 10^3$ Cps) soient suffisants pour réaliser une expérience de traceur en zone infralittorale ou sur le plateau continental. Des activités de 150 curies d' ^{110}Ag (Anon, 1972) ou de 92 curies de ^{46}Sc (Heathershaw, 1981) semblent injustifiées car l'activité par grain devient si forte qu'une saturation du détecteur se produit dans les zones de haute concentration et ainsi la précision des résultats s'en trouve diminuée.

L'immersion des traceurs se fait soit à l'aide de sacs solubles (Lavelle et al., 1978) soit à l'aide d'un système d'immersion qui s'ouvre en arrivant au fond. Ces systèmes sont peu encombrants du fait de la faible quantité de matériel à injecter (Fig. 4.2).

Les détections dynamiques sont généralement les plus utilisées et les résultats sont obtenus dans des délais très courts.

En conclusion, l'étude des transits sédimentaires par l'emploi de traceurs radioactifs est probablement l'approche la plus puissante qui existe en tracage sédimentaire. Utilisant de très faibles quantités de traceur (entre 500 g et 1000 g par injection) cette technique ne perturbe pas le milieu et les conditions de "bon mélange" sont réalisées très rapidement ce qui n'est pas le cas dans l'utilisation de quantités importantes (100 kg) comme dans le cas des autres techniques de tracage.

D'autre part, à cause de l'automatisation du travail sur le terrain, un contrôle permanent de déplacement sédimentaire est

effectuée in situ ce qui permet d'optimiser au maximum l'acquisition des données et de pouvoir déterminer avec précision la quantité de sédiment qui est mise en mouvement.

4.5 LES AUTRES TECHNIQUES DE MARQUAGES

Parallèlement aux expériences utilisant des traceurs luminescents et radioactifs, certains auteurs ont cherché à utiliser d'autres traceurs artificiels pour déterminer les transports sédimentaires. Ces différentes approches n'ont jamais abouti à l'élaboration de méthodes fiables pour déterminer quantitativement un transport sédimentaire.

a) LES TRACEURS MAGNETIQUES

Plusieurs auteurs ont essayé d'utiliser des traceurs magnétiques comme dérivatifs des traceurs radioactifs. Pantin (1961) les utilisa en incorporant du matériel magnétique dans des galets en béton. Griesseir et Hoeg (1964) et Hartke (1967) suggérèrent d'utiliser des sables magnétiques pour simuler les transports sédimentaires mais cette technique qui pourrait paraître séduisante n'a jamais été développée.

b) L'ANALYSE PAR THERMOLUMINESCENCE

Cette analyse fait appel aux propriétés des substances cristallines qui, soumises à une ionisation par rayonnement gamma ou RX, se transforment en un état électronique méta-stable facilement détectable. Si cette approche paraît très séduisante car le matériel rendu thermoluminescent n'est absolument pas affecté dans ses propriétés hydrodynamiques, le problème de la détection du traceur reste entier car aucun appareillage de

détection in situ n'est actuellement opérationnel. Des recherches sur cette méthode sont en cours au Centre Canadien des Eaux Intérieures (Nelson et Coakley, 1974).

c) L'ANALYSE PAR NEUTRO-ACTIVATION

Cette approche a été développée pour se substituer aux traceurs radioactifs lorsque l'utilisation de ces derniers n'était pas possible. Ces premières études ont été effectuées sous l'impulsion de Goldberg et Inman (1955) puis d'Inman (1958) et d'Inman et Chamberlain (1959). Plus récemment Groot et al. (1970, 1973) ont amélioré cette technique de tracage.

Cette méthode ne permet pas d'études quantitatives et son inconvénient majeur réside dans le fait qu'une très faible quantité de matériel peut être convenablement irradiée. Aussi la masse de matériel à irradier sous un flux très haut de neutrons est très grande et par conséquent la méthodologie est très lourde et les résultats sont très longs à obtenir. La grande qualité des mesures qui peut être obtenue par l'analyse de l'activation neutronique est annihilée par le peu de matériel irradié comptable dans le traceur. Pour obtenir un comptage statistiquement valable il faut allonger le temps de comptage et donc alourdir encore le processus d'analyse. Aucun réajustement d'échantillonnage n'est alors possible (Nelson et Coakley, 1974). Pour ces raisons il ne semble pas souhaitable dans l'état des connaissances actuelles d'utiliser cette approche sur le plateau continental.

4.6 CONCLUSION GENERALE

De cette revue bibliographique il ressort que seulement deux méthodes de tracage sont actuellement opérationnelles: les traceurs luminescents et les traceurs radioactifs. Les premiers ne permettent que dans des conditions très particulières d'obtenir des résultats quantitatifs. Une recherche des expériences de tracages menées par des profondeurs supérieures à -15 m (Tableau VII) montre que l'emploi de traceurs radioactifs en petite quantité (de l'ordre de 1 kg) peut permettre de suivre les transports sédimentaires sur une période suffisamment longue pour être représentative.

L'emploi d'un système autonome de mesures pourrait être intéressant au niveau du plateau continental car il permettrait de détecter de très petits mouvements sédimentaires.

L'utilisation de traceurs luminescents par grande profondeur semble ne pas être indiquée car elle implique une immersion d'une grande quantité de traceur et donc une période très longue pendant laquelle les conditions de "bon mélange" ne seront pas satisfaites.

Les différentes techniques de tracage de sédiments sableux ont été comparées par Duane et Judge (1969), un tableau de synthèse est donné dans l'annexe 1.

TABLEAU VII

Différentes expériences décrites dans la littérature dont la profondeur est supérieure à -15 m.

AUTEUR / ANNÉE	RÉGION	TYPE DE TRACEUR	PROFONDEUR	DURÉE	RÉSULTATS
Vernon (1966)	Catalina Isl. Caf. U.S.A.	luminescent détection en plongée	-30m	plusieurs mois	descriptif
Got (1970)	Baie de Banyuls France	détection dynamique Cr-51 (500g/13Ci)	-30m/-20m	60 j	descriptif (faible transport)
Longuemard (1974)	Atlantique France	Ta-192 (90g/150mCi) grille fixe automatique	-28m	une semaine	descriptif
Bratteland et Bruun (1974)	Ekofish Mer du Nord	luminescent (100 kg) détection en plognée	-70m	450 j	descriptif
Caillot <i>et al.</i> (1975)	Atlantique France	détection dynamique Ir-192 (900g/1.5Ci)	-22.5/-15m	90 j	quantitatif
Caillot <i>et al.</i> (1978)	Méditerranée France	détection dynamique Ir-192	-17.5m	210 j	quantitatif
Heathershaw (1981)	Swansea Bay U.K.	détection dynamique Sc-46 (653g/92Ci)	~ -17m	155 j	quantitatif
Quesney <i>et al.</i> (1982)	Baie de Seine France	détection dynamique Ir-192 (720g/1Ci)	-17.5m	208 j	quantitatif
Lees (1983)	East Anglia Coast U.K.	luminescent (750 kg)	-17m	231 j	quantitatif
Lavelle <i>et al.</i> (1978)	New York Bight U.S.A.	détection dynamique Ru-103 (590g/10Ci)	-21m -21.5m	64 j 76 j	quantitatif quantitatif

ANNEXE 1: Comparaison des méthodes de traçage des sables. D'après Duane et Judge (1969).

Fluorescent-Tagged Sand	Radioisotope-Tagged Sand	Stable-Tagged Sand Activation Analysis	Natural Minerals
Low to moderate cost; requires no special handling. EPS license.	Moderate to high cost; special handling and licensing (AECB and EPS)	Moderate to high cost; requires no special handling. EPS license.	Low cost; requires no special handling.
Sampling difficult; grab samples and limited numbers possible; sample validity in field; difficult to obtain.	Sampling easy; special equipment required; unlimited data potential; immediate indication of sample validity.	Sampling difficult; grab samples, limited numbers; no sample validity in field.	Sampling difficult; grab samples, limited numbers; characteristics of mineral may exhibit sorting and concentration not easily related to transport phenomena.
Analysis required on individual samples; interference from natural background minerals.	Analysis and sampling in situ.	Analysis required; interference from natural background minerals.	Analysis required on individual samples.
Sampling slow, not possible to obtain good representation of dynamic system.	Sampling fast; dynamic sampling in dynamic system.	Sampling slow, not possible to obtain good representation of dynamic system.	Sampling slow, not possible to obtain good representation of dynamic system.
Related data difficult to correlate with samples.	Samples easily correlated with other data.	Related data difficult to correlate with samples.	Related data difficult to correlate with samples.
Results of test lag field sampling.	Results of test rapid; initial evaluation ~ 24 hr.	Results of test lag field test.	Results of test lag field test.

ANNEXE 1: Continué

Fluorescent-Tagged Sand	Radioisotope-Tagged Sand	Stable-Tagged Sand Activation Analysis	Natural Minerals
Core sampling required for burial information	In situ sampling possible for burial determination or indicated by mathematical models.	Core sampling required for burial information.	Core sampling required for burial information.
Large quantities of tracer required 100 - 1000 kg.	Small quantities of tracer required 500 - 1000 g.	Large quantities of tracer required 100 - 1000 kg.	Source of mineral must be established and alternate sources must be absent.
Total data collection necessary to obtain direction, speed, and quantity of sediment; transport believed to be highly uncertain due to limited sample potential and statistical requirements.	Total data collection necessary to obtain direction, speed, and quantity of sediment; transport possible as indicated by mathematical models and wave tank experiments.	Total data collection necessary to obtain direction, speed, and quantity of sediment; transport believed to be highly uncertain due to limited sample potential and statistical requirements.	Data limited to determination of direction and distance of transport.
Public relations problems unlikely.	Public relations problems exist (problem can be minimized with proper control).	Public relations problems unlikely.	Public relations problems unlikely.
Survey area may be contaminated for future tests	Rapid clearing of survey area with short half-life isotopes.	Survey area may be contaminated for future tests.	Not possible to assign time to transport information or retest area.
Technique established and well developed.	Technique established and well developed; excellent potential for high utility.	Technique demonstrated; sensitivity problems.	Technique established and well developed.

4.7 RÉFÉRENCES

- Alquier, M., G. Courtois, J. Gruat et G. Sauzay, 1970. La notion de "bon mélange" dans l'emploi de traceurs. Vitesse débitante et vitesse du centre de gravité d'un nuage de traceurs dans l'étude d'un écoulement. La Houille Blanche, 7.70 : 643-650.
- Alquier, M., J. Gruat et G. Courtois, 1970. Utilisation de la formule d'Einstein. Comparaison avec la formule de Meyer-Peter dans le domaine du début d'entraînement. La Houille Blanche, 7.70 : 658-660.
- Anon, 1972. Out of sight, out of mind. Report of working party on sludge disposal in Liverpool Bay. HMSO. SBN 11-7504 56-4, vol. 2, Dept. of Envir., England, 483 p.
- Bastin, A., 1963. L'emploi de mesures de bruit de fond pour l'établissement d'une carte lithologique du fond de la mer. Compte rendu Réunion de Travail, Bureau Eurisotop, Euratom.
- Bastin, A., 1973. Natural radioactive tracers. In: Technical report series no 145-IAEA, Vienna.
- Becker, H. and H. Gotte, 1965. Procédé de marquage d'échantillons de sable naturel au moyen de substances radioactives. C.r. réunion Bruxelles, 2-5 Oct. 1963. Eurisotop, Cah. Inf. 8, communication 12 : 179-184.
- Bougault, H., 1966. Le marquage des sédiments pélagiques par l'or 198 et le chrome 51. Rapport de stage DR/S.R.S/66-37/BH/JJ.
- Bougault, H., A. Caillot, G. Courtois and B. Jeanneau, 1967. Dépôts superficiels de radioéléments sur les sables et les vases. In: Isotopes in Hydrology, Vienna, IAEA, p. 233-262.
- Bratteland, E. and P. Bruun, 1974. Tracer tests in the middle North Sea. Proceedings 14th Coastal Eng. Conf., Copenhagen, ASCE publ., 2 : 978-990.
- Bridge, J.S., 1981. Hydraulic interpretation of grain-size distribution using a physical model for bedload transport. J. Sediment. Petrol., 51 (4) : 1109-1124.
- Brown, P.J., R. Ehrlich and D.J. Colquhoun, 1980. Origin of patterns of quartz sand types on the southeastern United States continental shelf sedimentation - Fourier grain shape. Analysis J. Sediment. Petrol., 50 (4) : 1095-1100.
- Byerly, J.R., 1963. Naturally occurring radioactive mineral as littoral tracers. Shore and Beach, (April 1983).

- Caillot, A., 1970. Les méthodes de marquage des sédiments par des indicateurs radioactifs. *La Houille Blanche*, 7 : 661-674.
- Caillot, A., G. Courtois, P. Gourlez and G. Sausay, 1974. Les techniques nucléaires en sédimentologie dynamique. Rapport interne DCA/SAPRA/75-05/GS, 32 p.
- Caillot, A., P. Gourlez, J. Massias et G. Sauzay, 1977. Contribution à l'emploi des traceurs fluorescents en sédimentologie dynamique. Rapport CEN Saclay, SARR/77/15/C 248/PS, 23 p.
- Caillot, A., 1975. Action de la houle sur les sédiments. Synthèse des expériences faites en nature à l'aide de traceurs radioactifs. CEA Internal Report C-258, 105 p.
- Caillot, A., M. Quesney and G. Wilson, 1978. Contribution to the study of the movement of sediments along the Belgium littoral with radioactive tracers. CEA Internal Report, SAPRA/78/13.
- Caillot, A., 1979. L'utilisation des traceurs en sédimentologie dynamique. Rapport interne. DCA/SARR/SAPRA/70/09/C 259/AC, 45 p.
- Callesen, O. and K. Otterstrom, 1961. Methods of determining sand movement by means of radioactive labeled sand. In: International Congress of Navigation, 20th, Baltimore. Ocean Navigation, Sect. II, Brussels, Secrétariat Général, A.I.P.C.N., p. 41-49.
- Campbell, B.L., 1963. An improved technique for labelling sand with ^{198}Au . *Int. J. Appl. Radiat. Isotopes*, 14 (5) : 286-287.
- Campbell, B.L., 1964. Sediment research in Australia. *Atomic Energy Australia*, 7 : 13-17.
- Campbell, B.L. and B.W. Seatonberry, 1967. Surface labelling of sand with ^{51}Cr by thermal decomposition of ammonium dichromate ^{51}Cr . In: *Isotopes in Hydrology*, Vienna, IAEA, p. 227-232.
- Case, F.N., E.H. Acree and H.R. Brashear, 1971a. A survey system for use in tracing radionuclide-tagged sediment in the marine environment. In: *Nuclear Techniques in Environmental Pollution*, Vienna, IAEA, p. 603-628.
- Case, F.N., E.H. Acree and H.R. Brashear, 1971b. Detection system for tracing radionuclide labeled sediment in the marine environment. *Isotopes and Radiation Technology*, 8 : 412-414.
- Case, F.N., 1975. The application of radionuclide in the study of sediment transport and treatment of waste effluents. *Am. Nucl. Soc.*, 22 : 109-110.
- Chambers, R.L. and S.B. Upchurch, 1974. Distinction of dynamic provenances of sediments by R-mode factor analysis. In: North-Central Section, 8th Annual Meeting. *Geol. Soc. Am. Abstr.*, 6 (6) : 499.

- Clark, R.A. and R.H. Osborne, 1982. Contribution of salinas river sand to the beaches of Monterey Bay, California, during the 1978 flood period : Fourier grain-shape analysis. *J. Sediment. Petrol.*, 52 (3) : 0807-0822.
- Courtois, G., 1964. Possibilités d'emploi d'un nombre limité de grains radioactifs dans les études quantitatives de mouvements de sédiments. *Int. J. Appl. Radiat. Isotopes*, 15 : 655-663.
- Courtois, G. and R. Hours, 1965. Propositions concernant les conditions particulières d'emploi des radioéléments artificiels pour étudier les mouvements de sédiments. *Bur. Eurisotop., Cah. d'Inform.*, 8 (29) : 441-480.
- Courtois, G. and G. Sauzay, 1965. Possibilités de détermination quantitative des débits de sédiments par l'emploi de traceurs radioactifs : Utilisation de sondes à réponse linéaire. *Proc. 11th Int. Assoc. Hyd. Res. Conf., Leningrad*, p. 192-197.
- Courtois, G., 1966. Emploi de radioéléments en sédimentologie. Colloque sur l'emploi des radioéléments en hydrologie, SM 83/9, Vienna.
- Courtois, G. and A. Monaco, 1966. Méthode des traceurs radioactifs appliquée à l'étude des transits sédimentaires le long du littoral roussillonais. *Cah. Oceanog.*, 18 : 139-149.
- Courtois, G. and G. Sauzay, 1966. Count rate balance methods using radioactive tracer for measuring sediment mass flows. *La Houille Blanche*, 21 : 279-290.
- Courtois, G., 1968. The use of radioisotopes in sand movement and bedload material studies. In: *Guide Book on Nuclear Techniques in Hydrology*, IAEA, Vienna, p. 79-91.
- Courtois, G. and A. Monaco, 1968. Étude comparative de deux méthodes radioactives d'évaluation massive des transports sédimentaires littoraux. *Cahiers Océanographiques*, 20 : 775-783.
- Courtois, G. and A. Monaco, 1969. Radioactive methods for the quantitative determination of coastal drift rate. *Marine Geology*, 7 : 183-206.
- Courtois, G., 1970. La dynamique sédimentaire et les traceurs radioactifs (Point de la situation en France). *La Houille Blanche*, 7 : 617-628.
- Courtois, G. and G. Sauzay, 1970. Les masses de sédiment marqués à injecter dans une expérience de traceurs radioactifs en sédimentologie dynamique. *La Houille Blanche*, 7 : 629-642.
- Crickmore, M.J., 1964. A note on tracer methods for the field measurement of sand transport. *Internal Report INT 38, Hydraulics Research Station, DSIR, Wallingford, Berks, England*, 5 p.
- Crickmore, M.J. and G.H. Lean, 1962a. The measurement of sand transport by means of radioactive tracers. *Proceedings of Royal Society of London, Série A*, vol. 266.

- Crickmore, M.J. and G.H. Lean, 1962b. The measurement of sand transport by the time integration method with radioactive tracers. Proceedings of Royal Society of London, Série A, 270 : 27-47.
- Crickmore, M.J. and G.H. Lean, 1963. Methods for measuring sand transport using radioactive tracers. Radio-Isotopes in Hydrology, Symposium, Tokyo, AIEA, Vienna.
- Crickmore, M.J., 1967. Measurement of sand transport in rivers with special reference to tracer methods. Sedimentology, 8 : 175-228.
- De Vries, M., 1966. Applications of luminophores in sand transport studies. Delft Tech. Univ. Lab. Mining Rep., Pub. 39.
- De Vries, M., 1967. Photometric counter for fluorescent tracers. La Houille Blanche, 22 (7) : 717-722.
- De Vries, M., 1971. On the applicability of fluorescent tracers in sedimentology. Delft Hydraulics Laboratory, publication no 94, 17 p.
- Dolezal, R., M. Petersen, H. Becker, H. Goette, G. Schulze-Pillot, E. Tomschke, B. Boettcher, K.H. Nachtigall and E. Siebold, 1965. Development and testing of radioactive tracer method for measuring the kinetics of erosion and sand displacement caused by surf. EUR-2167.d, European Atomic Energy Community.
- Drapeau, G. and B. Long, 1984. Measurements of bedload transport in the nearshore zone using radioisotopic sand tracers. Abstract, 19th Coastal Eng. Conf., ASCE, Houston, Texas.
- Duane, D.B. and C.W. Judge, 1969. Radio-isotopic sand tracer study, Point Conception, California. Preliminary Report on accomplishments. July 1966 - June 1968. U.S. Army Coastal Engineering Research Center, Miscellaneous paper 2-69, 81 p.
- Duane, D.B., 1970a. Tracing sand movement in the littoral zone : progress in the radio-isotope sand tracer (RIST) study. U.S. Army Corps of Engineers Coastal Engineering Center, MP4-70, 52 p.
- Duane, D.B., 1970b. Synoptic observations of sand movement. Proc. 12th Coastal Eng. Conf., Washington, D.C., ASCE publ., p. 799-813.
- Duane, D.B. and W.R. James, 1980. Littoral transport in the surf zone elucidated by an Eulerian sediment tracer experiment. J. Sed. Petrology, 50 (3) : 929-942.
- Durham, R.W. et R.J. Gable, 1977. A radiotracer technique for measuring sediment movement. Rapport CCIW no 80, 16 p.
- Ehrlich, R., J.J. Orzeck and B. Weinberg, 1974. Detrital quartz as a natural tracer-Fourier grain shape analysis. J. Sed. Petrol., 44 : 145-150.

- Ehrlich, R., P.J. Brown, J.M. Yarus and R.S. Przygocki, 1980. The origin of shape frequency distributions and the relationship between size and shape. *J. Sediment. Petrol.*, 50 (2) : 475-484.
- Friedman, G.M., 1961. Distinction between dune, beach and river sands from textural characteristics. *Jour. Sed. Petrology*, 31 : 514-529.
- Friedman, G.M., 1967. Dynamic processes and statistical parameters compared for size frequency distribution of beach and river sands. *Jour. Sed. Petrology*, 37 : 327-354.
- Gable, G.C., Ed., 1981. Report on data from the Nearshore Sediment Transport Study Experiment at Torrey Pines Beach, California, January-February 1980. University of California, San Diego, Institute of Marine Resources, IMR Ref. no 80-5, S.I.O/UCSD 314 p.
- Gaucher, J.C., H. Got, J. Labeyrie, E. Lalou and A. Lansiaert, 1974. Application de la spectrométrie γ *in situ* à la cartographie granulométrique sous-marine. *Bull. B.R.G.M.* 2 (IV), 4-1974, 231-241.
- Gilbert, A. and S. Cordeiro, 1962. A general method for sand labelling with radioactive nuclides. *Int. J. Appl. Radiat. Isotopes*, 13 : 41-46.
- Goldberg, E.D. and D.L. Inman, 1955. Neutron-irradiated quartz as a tracer of sand movements. *Bulletin of Geological Society of America*, 66 : 611-613.
- Got, M., 1970. Résultat des expériences de traceurs radioactifs réalisées dans la baie de Banyuls. *Rapport CEA, SAR S/70/07*, 10 p.
- Got, H., 1971. Répartition du thorium, radium, potassium dans les sédiments du plateau continental Catalan. *C.R. Sc. Ac. Sci.*, Paris, Fr., 272.
- Got, H., 1974. Les variations de la radioactivité naturelle des sédiments superficiels du plateau continental pyreneo-catalan (Espagne). *Rapp. Comm. int. Mer Médit.*, 22 (8) : 37.
- Grant Gross, M., 1966. Distribution of radioactive marine sediment derived from the Columbia River. *Journal Geoph. Research*, 71 (8).
- Grant Gross, M. and J.L. Nelson, 1966. Sediment movement on the continental shelf near Washington and Oregon. *Science*, 154 (3750).
- Greenwood, B., P.B. Hale and P.R. Mittler, 1979. Sediment flux determination in the nearshore zone : prototype measurements. *In: Workshop on Instrumentation for Currents and Sediments in the Nearshore Zone*, NRC, Ottawa, p. 99-119.
- Griesseier, H. and S. Hoeg, 1964. Durch Ferromagnetika markierte Sedimente und Möglichkeiten ihrer automatischen Zählung. *Acta hydrophys.*, 9 : 35-53.

- Groot, A.J. de, E. Allersma, M. de Bruin and J.P.W. Houtman, 1970. Cobalt and tantalum tracers measured by activation analysis in sediment transport studies. In: Isotope Hydrology, IAEA, Vienna, p. 885-898.
- Groot, A.J. de *et al.*, 1973. Use of activable tracers. In: Technical report series no 145, IAEA, Vienna.
- Hartke, H., 1967. Quantitative determination of sediment accumulation under the effect of hydrodynamic conditions using magnetic tracers. Mber. dt. Akad. Wiss. Berl. 9 : 578 (in German).
- Heathershaw, A.D., 1981. Comparaisons of measured and predicted sediment transport rates in tidal currents. *Marine Geology*, 42 : 75-104.
- Hours, R., W.D. Nesteroff et V. Romanovsky, 1955. Méthode d'étude de l'évolution des plages par traceurs radioactifs. Raport C.R.E.O. I (11), 1965.
- Horn, R., F. Le Lann and M. Tireront, 1973. Recherche d'ilménite au large des côtes du Sénégal. BRGM, 74 SGN 256 MAR.
- Hubbel, D.W. and W.W. Sayre, 1964. Sand transport studies with radioactive tracers. Proceedings of the American Society of Civil Engineers, 90 (HY3).
- Hudson, C.B. and R. Ehrlich, 1980. Determination of relative provenance contributions in samples of quartz sand using Q-mode factor analysis of Fourier grain shape data. *J. Sediment. Petrol.*, 50 (4) : 1101-1110.
- Huston, K.H., 1963. A critical appraisal of the technique of using naturally occurring radioactive minerals as littoral tracers. Institute of Engineering Research, Hydraulic Engineering Laboratory Wave Research projects, HEL-4-1, University of California, California.
- Ingle, J.C. Jr., 1962. Tracing beach sand movement by means of fluorescent dyed sand. *Shore Beach*, 30 : 31-36.
- Ingle, J.C. and D.S. Gorsline, 1973. Use of fluorescent tracers in the near-shore environment. In: Tracer Techniques in Sediment Transport. Technical Report Series no 145, pp. 125-148, IAEA, Vienna.
- Inman, D.L., 1958. Experiments with artificially radioactive sand as tracers of shelf sediment movement. Proc. 2nd Int. Conf. Peaceful Uses of Atomic Energy 15/P/1981.
- Inman, D.L. and T.K. Chamberlain, 1959. Tracing beach sand movement with irradiated quartz. *J. Geoph. Res.*, 64 (1) : 41-47.
- Inman, D.L., J.A. Zampol, T.E. While, D.M. Hanes, B.W. Waldurf and V.A. Kostens, 1980. Field Measurements of Sand Motion in the Surf Zone. 17th Int. Conf. on Coastal Eng., 1215-1234.

- Jeanneau, B., 1965. Étude des dépôts d'argent sur les sédiments siliceux en vue de les marquer par ^{198}Au , expériences faites sur un sable de rivière. Internal Report DR-AR/65, Section d'Application des Radio-éléments de Saclay, Centre d'Études Nucléaires.
- Jolliffe, I.P., 1963. A study of sand movements on the Lowestoft sand bank using fluorescent tracers. *Geographical Journal*, vol. 129.
- Judge, C.W., 1970. Heavy minerals in beach and stream sediments as indicators of shore processes between Monterey and Los Angeles, California. U.S. Army Coastal Engineering Research Center, Technical memorandum 33.
- Kidson, C. and A.P. Carr, 1962. Marking beach materials for tracing experiments. *American Soc. Civil Engrs., Jour. Hydraulics Div. Paper 3189*, 18 p.
- Klovan, J.E., 1966. The use of factor analysis in determining depositional environments from grain size distributions. *Jour. Sed. Petrology*, 36 : 115-125.
- Lavelle, J.W., D.J.P. Swift, P.E. Gadd, W.L. Stubblefield, T.N. Case, H.R. Brashear and K.W. Haff, 1978. Fair weather and storm sand transport on the Long Island, New York, inner shelf Sedimentology. *Jour. Sed. Petrology*, 25 : 823-842.
- Lean, G.H. and M.J. Crickmore, 1963. Methods for measuring sand transport using radioactive tracers. *In: Radioisotope in Hydrology*. Vienna, International Atomic Energy Agency, p. 111-131.
- Lees, B.J., 1979. A new technique for injecting fluorescent sand tracer in sediment transport experiments in a shallow water marine environment. *Mar. Geol.*, 33 (3-4) : M95-M98.
- Lees, B.J., 1983. The relationship of sediment transport rates and paths to sand banks in a tidally dominated area off the coast of East Anglia. *U.K. Sedimentology*, 30 : 461-483.
- Lees, B.J., 1983. Sizewell Dunwich Banks field study topic report 7. Final report - a study of nearshore sediment transport processes. *Inst. Oceanogr. Sci. Report no 146*, 46 p.
- Long, B., 1977. Determination of sediment transport rate in the Minas Basin, Nova Scotia. Preliminary results of the first tracer experiment using radio-isotopes. *Geol. Sur. Can., Paper 77-1B*, p. 85-92.
- Long, B.F. et J.P. Barousseau, 1978. A method for the analysis of the sediment evolution. An exemple during the last 3000 years in the Bay of Biscaye. France 10th International Congress on Sedimentology, Jerusalem 78. Abstract book.
- Long, B., N. Kulkarni and G. Joice, 1978. Radioisotopes as sediment tracers: risks involved and proposed guidelines for use. *B.I.O. report series, B.I.O.*, 78-3. 38 p.

- Long, B.F. et G. Drapeau, 1983. Évolution du transport sédimentaire par traceur radio-actif sur la zone infralittorale de la Basse Côte Nord. Canadian Coastal Conference '83, Vancouver, B.J. Holden, ed., p. 201-215.
- Longuemard, J.P., 1974. Sur une nouvelle méthode d'étude des transits sédimentaires sur les plateaux continentaux. Mem. Inst. Geol. Bassin Aquitaine, no 7 : 369-376.
- Markovich, J.V., R. Ehrlich and B. Weinberg, 1976. New techniques for stratigraphic analysis and correlation - Fourier grain shape analysis Louisiana offshore Pliocene. Jour. Sed. Petrology 46 : 226-233.
- McLaren, Patrick, 1981. An interpretation of trends in grain size measures. Jour. Sed. Petrology, 51 (2) : 0611-0624.
- McLaren, W.A., and W.R. Buckingham, 1983. Sand movement study in Fraser River foreshore. Proceedings Canadian Coastal Conference, May 11-14, 1983, B.J. Holden (ed.), p. 217-233.
- McMaster, R.L., 1966. Mineralogy as an indicator of beach sand movement along the Rhode Island shore. Jour. Sed. Petrology, 30 (3) : 404-413.
- Meyn, G., 1965. Technique de marquage radioactif pour l'étude des mouvements de sable dans les eaux côtières allemandes. C.r. réunion Bruxelles, 2-5 oct. 1963. Eurisotop, Cah. Inf. 8, communication 14, p. 195-200.
- Miller, J.M. and G.D. Symons, 1973. Radiometric traverse of the seabed off the Yorkshire coast. Nature, 6.B : 242.
- Minami, K., 1965. Measurement of sand-drift on the seabed by a water-tight G-M detector. Radioisotopes (Tokyo) 14 : 83-88.
- Nelson, D.E. and J.P. Coakley, 1974. Techniques for tracing sediment movements. Scientific Ser., no 32, Inland Waters Directorate, Canada Centre for Inland Waters, Burlington, Ontario, 40 p.
- Olsen, C.R., P.E. Biscaye, H.J. Simpson, R.M. Trier, K. Kostyk, R.F. Bopp, Y.H. Li and H.W. Feely, 1980. Reactor-released radio-nucleides and fine grained sediment transport and accumulation patterns in Barnegat Bay, New Jersey and adjacent shelf waters. Estuarine Coastal Mar. Sci., 10 : 119-142.
- Pantin, H.M., 1961. Magnetic concrete as an artificial tracer material. New Zealand, J. Geol. Geophys., 4 : 424-433.
- Patrikeyev, V.V. and G.A. Orlova, 1968. A new method of marking and quantitatively estimating tracer sands and silt in bottom samples. Trans. by American Geophysical Union, Oceanology, 8 (2) : 276-280.

- Petersen, B.R., 1960. Some radioactive surface labeling methods. *Ingeniøren*, 4 : 99-102.
- Petersen, M., 1965. Risques inhérents à l'utilisation des radioisotopes et mesures de protection requises. C.r. réunion Bruxelles, 2-5 oct. 1963, *Eurisotop*, Cah. Inf. 8, communication 27, p. 411-416.
- Pilon, J.J., 1965. Mesures par traceurs radioactifs du mouvement des sables aux Pays-Bas, 1957-1962. C.r. réunion, Bruxelles 3-5 oct. 1963, *Eurisotop*, Cah. Inf. 8, communication 15, p. 201-314.
- Porter, G.A., R. Ehrlich, R.H. Osborne and R.A. Combellick, 1979. Sources and nonsources of beach sand along southern Monterey Bay, California - Fourier shape analysis. *Jour. Sed. Petrology*, 49 (3) : 727-732.
- Putman, J.L., B.D. Smith, F. Allen et G. Rowan, 1954. Thames siltation investigation, preliminary experiments of the use of radioactive tracers for indicating mud movement. Rapport AERE/I/R/1576.
- Quesney, M., R. Hoslin and J. Massias, 1982. Étude au moyen de traceurs radioactifs des mouvements sédimentaires en Baie-de-Seine. Rapport OR15/SAR/S-82-22/04, 75 p.
- Rice, R.M., D.S. Gorsline and R.H. Osborne, 1976. Relationships between sand input from rivers and the composition of sand from the beaches of Southern California. *Sedimentology*, 23 : 689-703.
- Rispal, C., 1962. (Patent to Commissariat à l'Énergie Atomique), Radioactive labeling of sandy sediments. Fr. 1,338,882, Oct. 4, 1963; Appl. June 25, 1962; 12 p.
- Rivière, A., 1965. Intérêt sédimentologique de la mesure des radioactivités naturelles. *C.R. Acad. Sciences*, 241 : 964-966.
- Rivière, A. et S. Vernhet, 1966. Études littorales. Contribution à l'étude des rivages du golfe de Lion. Signification sédimentologiques des radioactivités naturelles. *Cahiers océanographiques* no 10 : 857-900.
- Ross, D.A., 1978. Atlantic continental shelf and slope of the U.S.; heavy minerals of the continental margin from southern Nova Scotia to northern New Jersey. *U.S. Geol. Surv., Prof. pap.*, no 529-G, 43 p.
- Russell, R.C.H., D.E. Newman and K.W. Tomlinson, 1963. Sediment discharges measured by continuous injection from a point. *Proc. 10th Congr. Int. Assoc. Hyd. Res.*, London, 1 : 69-76.
- Sauzay, G., 1968. Méthode du bilan du taux de comptage d'indicateurs radioactifs pour la détermination du débit de charriage des lits sableux. Rapport CEA-R no 3431, 162 p.

- Sauzay, G. and G. Courtois, 1970. Radioactive tracers applied to measurements of suspended load and bedload discharge. Proc. Koblenz Symp. on Hydrometry, Unesco/UMO/IAHS, 2 : 627-635.
- Sayles, F.L., 1966. A reconnaissance heavy mineral study of Monterey Bay beach sediment. Hydraulic Engineering Laboratory, University of California, Berkeley, HEL-2-16.
- Schulz, H. and G. Pillot, 1965. Détermination quantitative des mouvements de sable. C.r. réunion Bruxelles, 2-5 oct. 1963. Eurisotop, Cah. Inf. 8, communication 25 : 401-406.
- Smith, D.B. and J.D. Eukins, 1957. Radioactive methods for labeling and tracing sand and pebbles in investigations of littoral drift. Unesco/NS/RIC/63 Pergamon Press, London.
- Stephens, N.H., E.H. Acrie and F.N. Case, 1968. Evaluation of four methods using Gold 198 for surface labeling sand and a new technique for simulating mass labeling. Oak Ridge National Laboratory Report ORNL-4338, p. 9.
- Stuiver, M. and J.A. Purpura, 1968. Application of fluorescent coastal sand in littoral drift and inlet studies. Proc. 11th Coastal Eng. Conf., London, ASCE publ., p. 307-321.
- Tashjian, Z., J. Cherry, G. Gordon and M. Gablinger, 1964. Radiometric determination of thorium in coastal sands for tracing littoral sediment. Hydraulics Engineering Lab., Report HEL 5-3, University of California, Berkeley.
- Teleki, P.G., 1967. Automatic analysis of tracer sand. Journal of Sedimentary Petrology, 37 : 749-759.
- Tola, F., 1982. The use of radioactive tracers in dynamic sedimentology. Rapport CEA-N-2261, 42 p.
- Trask, P.D., 1952. Source of beach sand at Santa Barbara, California, as indicated by mineral grain studies. U.S. Army Corps of Engineers, Beach Erosion Board, Technical Memorandum no 28.
- Vernon, J.W., 1966. Shelf sediment transport system. Ph.D. dissertation in Geological Sciences, University of Southern California.
- Visher, G.S., 1969. Grain size distributions and depositional processes. Jour. Sed. Petrology, 39 : 1074-1106.
- Vukmirovic, V., A. Filip, P. Todorovic and R. Vukotic, 1964. Radioactive tracers in studying bed load movement. Trans. Inst. Jaroslav Cerni, 31. 9 (31) : 31-38.
- Yasso, W.E., 1962. Fluorescent coatings on coarse sediments; an integrated system. Off. Naval Res. Geog. Br., Tech. Rpt. #1, Proj. NR 388-057, Contr. Nonr. 266 (68), 48 p.

CHAPTER 5
DIRECT AND INDIRECT
METHODS FOR MEASURING SEDIMENT TRANSPORT

by

DAVID A. HUNTLEY

Department of Oceanography
Dalhousie University

and

GEORGES DRAPEAU

INRS - Oceanologie
Universite du Quebec

5.1 INTRODUCTION

Chapter 2 concluded that improving the prediction of sediment transport depends upon gathering better field data from continental shelves. The purpose of this chapter is to review techniques, other than tracer studies (which are the subject of Chapter 4), for making field measurements of sediment transport.

There are three basic reasons for making in situ observations. Firstly, we need to improve our basic understanding of the physical processes of sediment transport, generally by fine-scale observations of sediment transport events. Secondly, measurements under carefully measured hydrodynamic conditions are desperately needed to test the empirical and semi-empirical formulae for sediment transport. Needed are in situ observations of threshold stresses (Section

2.2), and transport rates (Section 2.3) as functions of grain size. Thirdly, in the absence of good predictions of sediment transport, the field measurements themselves are needed for many practical purposes by industries working on the continental shelf.

Each of these reasons produces its own set of requirements. Thus basic studies of processes require detailed, fast-response measurements, generally at a single point. On the other hand, for many practical purposes it is the net erosion or deposition over an area of the seabed which is of most importance. This involves measurement of the spatial derivatives of sediment transport rates (see equation 6.1), and usually requires much longer periods of observation than are typical in process studies.

In this Chapter we distinguish between direct and indirect methods of measuring sediment transport. Direct methods are those which observe the sediment in motion. These techniques generally involve multiplying a sediment concentration measurement by a velocity measurement to obtain an estimate of sediment flux. Indirect methods, on the other hand, estimate sediment transport rates and directions by measuring the results of sediment transport, such as erosion, deposition, tracer motion and the movement of bedforms, rather than the transport events themselves. Generally direct methods will be more important to process studies while indirect methods will yield results of more immediate practical use. Both methods will produce data which can be useful in testing predictive formulae.

The following section, 5.2, describes sensors capable of

measuring suspended sediment load, possible sensors for measuring bedload, and ends with a brief review of some sensor systems which have been used on continental shelves. Section 5.3 outlines some indirect techniques which have not been covered in Chapter 4, and we end, in Section 5.4, with concluding remarks and suggestions for future work.

5.2 SENSORS FOR DIRECT MEASUREMENTS

For sheltered locations, where steady currents dominate and wave motion is small, direct measurements of sediment transport can be obtained relatively simply. For example Lees (1983) used a pumping system to obtain suspended sediment samples from six different heights above the bed, and rotor current meters to measure tidal currents, in a tidally dominated location in the North Sea. Measurements of sediment concentration were made every half hour.

For much of the continental shelf, however, and particularly the Sable Island Bank region of the Scotian Shelf, wave motion forms an important part of the total velocity field, especially during storms. Where sediment motion is primarily by bedload or by resuspension of bed material by irregular wave motion the product of mean concentration and mean current will not predict sediment transport rates adequately. An extreme example of this was described in Section 2.4. For some conditions of combined wave and current flow over seabed ripples, the sediment flux is against the direction of the mean flow. Estimation of sediment flux in wave and current regions therefore requires measurement of the fluctuations of both sediment concentration and velocity,

not the product of a time average of velocity and a time average of concentration. Thus, even if we are ultimately only interested in a long-term average transport rate, in regions of appreciable wave activity we must measure sediment motion rapidly enough to monitor changes during a wave cycle.

Methods for measuring sediment transport rates have been developed for the littoral zone in recent years (Sayao and Kamphuis, 1983). Much of this methodology can be used on continental shelves but there are important differences between the two environments. In the littoral zone, most sediment transport takes place parallel to the shoreline, while on the continental shelf, measurements must be capable of resolving motion in all directions. Water depths in the littoral zone are generally shallow enough to allow ready access to instruments in situ, but in many shelf locations sensors must be deployed and operated remotely.

Huntley (1982), in a review of sensors for measuring sediment transport in the littoral zone, defines the ideal instrument for direct measurement of sediment movement as follows. It "will have a response time of around 0.1s, in order to respond to rapid changes during a wave period, and will, as far as possible, have sensors remote from the measurement volume, so as to minimise flow disturbance. Vertical resolution will need to vary with position above the bed. For suspended sediments a 1 cm resolution over the lowest 1 m of the water column will probably be adequate. For bedload transport (in which grain-grain collisions are important) a resolution of 1 mm will be

necessary in order to measure adequately the thickness of the moving bedload layer, which is expected to be on the order of 0.5 cm thick".

The sediment transport rate across a unit area is the time average of the product of the sediment concentration and the velocity representative of that concentration. The discussion which follows describes sensors which measure sediment concentration, and assumes that suitable fast response measurements of velocity can be made concurrently. Unfortunately, for the systems which have been deployed on continental shelves (Section 5.2 c), this assumption is not justified, particularly for the vertical resolution discussed above. However existing instrumentation and experience probably can provide velocity data adequate enough to ensure that uncertainties in the final transport measurements are not due primarily to velocity measurements.

In the following it is convenient to make the somewhat arbitrary distinction between suspended sediment transport and bedload transport. We discuss first suspended sediment sensors, then bedload sensors and finally review some recent instrumentation systems which have been deployed for direct measurements of sediment transport on the continental shelf.

a) SUSPENDED SEDIMENT SENSORS.

i) Optical Sensors.

Systems using visible light have been the most common sensors used on the continental shelf. These sensors measure the scattering of light by suspended particles, through the processes

of diffraction, reflection and refraction. Transmissometers measure direct light transmission across a water path of chosen length, while other sensors, sometimes known as nephelometers, measure the radiation scattered out of the direct beam, usually at 90° or 180° to the main beam direction.

Although optical sensors can be made with fast response times, small size and low power drain, a major disadvantage is the strong dependence of transmission and backscatter on both the size and refractive index of the sedimentary particles. For example, at a wavelength of $0.5 \mu\text{m}$ the attenuation coefficient for silt (diameter $1 \mu\text{m}$) is three orders of magnitude higher than for a similar concentration of coarse sand (diameter 1mm). Thus in an environment with mixed grain sizes in suspension, the finer grain sizes will dominate the sensor response, possibly masking measurements of the resuspension of coarser material. Some distinction between particle size, refractive index and concentration can be made using simultaneous measurements of transmission and scatter into different angles and perhaps using different wavelengths of light. Even if this is done, however, it will generally be necessary to collect in situ samples of suspended material in order to calibrate the data from optical sensors in terms of sediment concentrations.

Transmissometers are produced commercially by many companies and range from sensors designed to measure very low concentrations of organic particles in the open ocean to sensors designed for high concentration, near-bed measurements. The combined transmissometer/nephelometer (90° scattering) described

by Butman and Folger (1979) had a quoted resolution of 0.05% transmission and an accuracy of about 5% transmission. The more recent Sea-Tech transmissometer described by Bartz et al. (1978), and used in the High Energy Benthic Boundary Layer Experiment (HEBBLE) project, has a resolution of about 0.02% and a long term calibration stability of better than 0.1% over six weeks, in the absence of fouling. Translating these specifications into expected accuracies of sediment concentration estimates depends, of course, on the ambient conditions. Where suspended sediment concentrations are high enough to cause a very low percentage transmission, the transmission resolution limitations will lead to large uncertainties in concentration. The path length of the transmissometer must therefore be chosen carefully to match the concentrations and grain sizes expected. Bennett¹ working in the Bay of Fundy, was able to provide an in situ calibration of the Sea-Tech transmissometer with a scatter of less than 7% root mean square amplitude (rms).

Very close to the seabed, the bulkiness of a transmissometer (which must have a source and a detector separated by the path length of the instrument) can modify the conditions being measured significantly. In this case a backscatter sensor, with source and detector mounted side-by-side in a single small sensor package, is generally preferable. The OBS (Optical Backscatter Sensor) described by Downing et al. (1981) is such a sensor, though it has to date been used only in the littoral zone.

¹ A. Bennett, Bedford Institute of Oceanography, Dartmouth, N.S.
(personal communication)

Designed for sand sized particles, this sensor consists of five backscatter sensors mounted on a rod to measure the vertical profile of concentration within 56 cm of the seabed (or 15 cm of the bed in a miniature version). The sensor must be calibrated using samples of sediment gathered at the field site. The output is a linear function of concentration, but the scatter of individual measurements can be large (up to 20%). In part this scatter occurs because the sampling volume of the OBS is small (about 1 cm^3), and this leads to a somewhat "noisy" output. Ideally a larger sampling volume, comparable with that of associated flow sensors, should be used, and probably this could be achieved by some redesign of the OBS.

An ingenious device combining a fast-response optical sensor with a pump sampling system is described by Thornton and Morris (1977). A remote pump drew water through one of three nozzles held on a bottom-mounted frame, and a forward-scatter optical sensor viewed the pumped sample through a glass tube about 2 m from the nozzle. The pumped samples were also collected remotely, typically for two minutes, so as to provide a measure of the mean concentration, and thus provide some rough in situ calibration of the optical sensor. Although used only in the littoral zone to date, this combination of fast response optical measurement and in situ calibration is probably worth further investigation, particularly for shallow shelf locations, where pumping to a ship may be possible.

ii) Acoustic Sensors

High frequency (0.5 to 15 MHz) acoustic waves have wavelengths comparable with visible light wavelengths, and they

therefore scatter from suspended particles in a similar way to light. However, acoustic sensors have two significant advantages over optical sensors. Firstly, there are no strong absorption peaks for transmission of acoustic waves through water alone, as there are for visible waves. This allows the use of a greater range of acoustic frequencies and thus some matching of acoustic wavelengths to the sizes of the particles being monitored. Secondly, the much slower propagation speed of sound allows the backscattered signal to be "range-gated" so that profiles of suspended sediment concentration can be estimated with a single instrument. Typically, resolution of this range-gating is 1 cm over a 100 cm path, though a resolution close to 1 mm has been achieved for bedload sensors.

Several acoustic profiling devices have been built for measuring concentration profiles of suspended sediment near the seabed. All have a transducer mounted about 1.5 m above the seabed looking downwards. Acoustic pulses are transmitted typically every second and provide a profile, with a vertical resolution of 1 cm. Thus time series of suspended sediment concentration profiles are produced rapidly and remotely.

The National Oceanographic and Atmospheric Administration Atlantic Oceanographic and Meteorological Laboratory (NOAA-AOML) 3 MHz system (Young et al., 1982) has been deployed in about 10 m water depth on the Long Island inner shelf and has provided extensive data on suspended sediment processes in that region (Vincent et al., 1982). The Ohio State University 3 MHz C-DART system (Bedford et al., 1982) was deployed from a tower in 4-10 m

depths in Lake Erie as part of a programme to measure coastal sediment transport. The Acoustic Back Scatter Sensor (ABSS) 5 MHz system developed at Woods Hole is being used as part of the HEBBLE project. It has been deployed in about 5,000 m water depth off the Nova Scotian shelf. The ABSS also incorporates an upward looking 500 kHz sensor range-gated to about 1 m resolution, to sense suspended sediment concentrations above the sensor. Finally, the Canadian Coastal Sediment Study, coordinated by the National Research Council of Canada, is developing an acoustic profiler for use in the littoral zone. It incorporates the ability to measure accurately the location of the seabed, as well as the profile of suspended sediment above it.

The accuracy of the concentration estimates made by these profiling instruments appears to be limited at present by the difficulty of providing a satisfactory calibration. Vincent et al. (1982) estimate an accuracy of no better than a factor of three for their measurements on the Long Island shelf, and Young et al. (1982) discuss some of the problems encountered in laboratory calibration. This accuracy may be improved by further calibration in a carefully controlled facility. Even if not, however, the profiling capabilities, and the non-interfering nature of the measurements, make these sensors very attractive compared to optical sensors.

The profiling system built at NOAA-AOML is still under development, the most recent addition being an acoustic transverse Doppler velocity profiler. A central transducer emits a collimated pulse of sound which defines a single sampling

volume. The acoustic backscatter from this volume is detected by auxiliary Doppler sensors mounted transversely, which measure the components of the velocity profile below the emitter. This system is designed to provide simultaneous velocity and suspended sediment profiles, giving direct measurements of suspended sediment flux.

Other acoustic systems for suspended sediment measurements in the ocean measure the attenuation of sound across a chosen path. Whilst these systems do not provide profiles, they can integrate sediment concentration over a larger volume, and this can be an advantage if local inhomogeneities are expected or if velocity measurements integrate over similarly larger volumes. Wenzel (1974) describes a system which combines acoustic current measurements with sound absorption due to sand in suspension within a 60 cm diameter ring. Barkmann et al. (1983) at the University of Kiel use attenuation of sound in the 10 MHz range to measure sub-micron bubbles and particulate matter.

Probably the most advanced acoustic system for measuring concentration and velocity in a single volume, is the system developed at the Delft Hydraulics Laboratory (Jansen, 1979). The sensor (known as the Ultrasonic Sand Transport Monitor) operates at a frequency of 4.5 MHz, to minimise sensitivity to silt and maximize sensitivity to sand. Two versions of the system are available. One measures a single component of velocity and concentration in a frame designed to be lowered from a ship or platform to a maximum depth of 50 m, and to orient itself to the mean flow direction. Thus it is useful primarily in regions with

relatively small wave-induced currents. A second version is designed to be mounted to a fixed structure and has four probes to measure velocity in two orthogonal directions. The accuracies claimed for these systems is very high, being 5% for concentrations of known grain size and 30% for unknown grain sizes. The response time is 0.1 s. The concentration and velocity signals can be multiplied together internally to provide a time series of suspended sediment transport rate at the depth of the sensor. The system has been tested extensively in the estuaries of Holland but has not, to our knowledge, been used in exposed continental shelf regions.

iii) Impact Sensors

An impact sensor for suspended load is being developed at the Institute of Oceanographic Sciences (Salkield et al., 1981). The sensor consists of a 6 mm diameter disc of piezo-electric ceramic mounted into the flow so that the suspended sand grains strike its front face. Using an independently measured velocity, the sand concentration is derived from the impact rate. The height of each impact voltage pulse is proportional to the momentum of the grain, so that a crude grain size distribution can be obtained by pulse height discrimination.

Soulsby et al. (1983) describe in some detail field trials of this sensor in a tidally dominated bay and in an estuary. Their results, though clearly preliminary, are encouraging, and may even allow some investigation of the turbulent diffusion of sediment as well as advection by mean flows. Clearly, however, this sensor is designed for conditions of unidirectional flow and is thus limited to regions where wave orbital velocities are

small compared to the mean flow.

iv) Mechanical Samplers

Most mechanical methods rely either on in situ trapping of a volume of water in an oceanographic bottle or other device, or on pumping a volume of water either through a hose to a remote location or into arrays of sampling bags or rigid containers.

Trapping of sediment samples has the major advantage of providing an unambiguous measure of concentration and grain size distribution. Bennett¹, for example, used a rosette sampler in a tidal environment to calibrate a transmissometer to an accuracy of better than 7%. However such measurements are time-consuming, cannot respond to rapidly changing conditions (particularly under waves), and usually involve large mounting devices which can interfere significantly with the flow, particularly near the seabed. Attempts have been made, both at Scripps Institute of Oceanography and at the University of Washington, to circumvent the sampling time limitation by designing traps which close extremely rapidly on command. For example Dr. Dungan Smith at the University of Washington designed a sampler which uses an explosive charge to close a trap. However, when used in a wave-dominated environment and compared to records from the OBS it proved very difficult to synchronise the firing of the traps accurately with the changing wave currents. Many trap measurements also would be needed to monitor concentration

¹ A. Bennett, Bedford Institute of Oceanography, Dartmouth, N.S. personal communication.

changes over a typical wave period.

Pumping techniques suffer from many of the same disadvantages, though they may be used to provide a time average of the concentration over a chosen period, and this may be a useful measurement. For accurate measurements care must be taken to adjust the pumping rate so that intake velocities do not perturb the ambient flows significantly. Thornton and Morris (1977), for example, carefully adjusted their pumping rate to match ambient flow conditions in their nearshore environment. In some conditions this requirement may be incompatible with the need to pump water fast enough to keep sand in suspension in the pumping line. Thus Soulsby et al. (1983) report problems with sediment settling out in their pumping line and estimate that it could take up to 25 minutes for samples to travel through their shallow water pumping line. Coakley et al. (1978) avoid some of these problems for the littoral zone by pumping samples a short distance into up to 30 sampling bags mounted on a remotely operated sled. However this results in a rather cumbersome framework to hold the sampling system which may significantly perturb the ambient conditions.

b) BEDLOAD SENSORS

Huntley (1982) summarized the bedload transport problem as follows: "Bedload transport is much more difficult to measure than suspended sediment transport because it involves high concentrations, small vertical scales (a few millimetres) relatively low velocities and often occurs concurrently with suspended sediment transport."

As will be seen as we discuss different types of sensors, there are no viable techniques for direct measurements of bedload transport at present. Bedload transport is more amenable to time-integrating indirect techniques such as trapping and tracing.

i) Acoustic Sensors

Potentially the most promising sensor for direct measurement of bedload transport is under development at the Scripps Institute of Oceanography (Lowe, 1980). It measures the thickness of the moving bed layer by discriminating between reflections from the sediment-water interface and from the interface separating moving grains from underlying stationary grains. The design also involves acoustic doppler techniques to measure the speed of the surface bedload layer. Preliminary field and laboratory trials are encouraging but it will probably be some time before the sensor is developed to the point where it could be used routinely.

Another acoustic technique which has been suggested for measuring bedload transport listens to the acoustic noise generated by bedload collisions between grains. It is suggested that the frequency of the noise will be related to grain size whereas the intensity will relate to the rate of transport. However, although some trials have been made using the technique (e.g. Anderson, 1976; Richards and Milne, 1979), it has not yet been developed to the point of being useful.

ii) Impact Sensors.

The principle used to measure bedload transport by grain

impact is the same as for suspended sediments. Downing (1981) describes an impact whisker target which is a stainless steel wire 1 mm in diameter and 50 mm long, clamped at one end between two pairs of piezo-electric discs. This sensor was used successfully to measure bedload transport in a river. However, due to its fragility and the need to maintain a constant length of whisker penetrating into the bed, it would be very hard to use on the continental shelf.

iii) Mechanical Samplers

Bedload sand traps have been widely used in both steady flow (e.g. Downing, 1981) and wave dominated (e.g. Thornton, 1973) environments. However they suffer from all of the disadvantages of traps previously discussed and inevitably are major perturbations on the environments they attempt to monitor. They will provide useful results only if carefully monitored for scour and deposition throughout a deployment, and they are, therefore, of limited applicability to continental shelf environments.

c) INSTRUMENT SYSTEMS FOR SEDIMENT TRANSPORT STUDIES ON CONTINENTAL SHELVES

Despite the range of instruments described above, surprisingly few have been deployed on continental shelves, particularly in locations where wave motion is significant. This section reviews some of the systems which have been deployed, particularly on the shelves of North America. Although development of these systems required considerable time and

effort they are still primarily useful only for studying processes of sediment transport. None yet provides a direct measurement of sediment flux which is adequately accurate for testing sediment transport formulae, though threshold estimates and direct observations are clearly useful. Certainly we are not yet able to make direct measurements which are of immediate practical use.

The United States Geological Survey (USGS) at Woods Hole (Butman and Folger, 1979; Butman et al., 1979) developed a tripod equipped with a Savonius rotor current meter mounted 1 m above the seabed, a quartz-crystal pressure sensor, a transmissometer-nephelometer (90° scatter) mounted 2 m above the seabed, a thermistor and a 35 mm deep sea camera. This system records data internally and is capable of operating unattended for up to eight months in burst and interval mode. Nine systems were constructed and deployed, some 40 times, at locations spanning the length of the Atlantic continental shelf of the United States. This Woods Hole system has provided valuable qualitative information on the threshold of sediment motion and the mode of sediment transport once sediment is moving. However it does not have the capability of making quantitative measurements of sediment transport rates. No attempt was made to measure the vertical profiles of either current or suspended sediment concentration.

In Canada, the Bedford Institute of Oceanography has developed RALPH, a tripod system to monitor sediment dynamics (Heffler, 1979). This system is equipped with a 35 mm camera for time lapse photography, an electromagnetic current meter, an

optical transmissometer, an upward-looking sonar for tide and wave measurements, a conductivity cell for salinity measurements and a temperature probe. Its capabilities are similar to the Woods Hole system.

Researchers at the USGS at Menlo Park (Cacchione and Drake, 1979; Drake et al., 1980; Cacchione and Drake, 1982) have developed another instrumented tripod which they named GEOPROBE. This system uses electromagnetic current meters to measure flow velocities at four levels, 20, 50, 70, and 100 cm above the seabed. It is also equipped with a quartz crystal pressure sensor, a transmissometer, a nephelometer, a thermistor and a 35 mm underwater camera. As the camera system is activated when current speeds exceed preset threshold values, it is well adapted to identify initial sediment motion and bedform development. Like the tripod system from the USGS at Woods Hole, it measures transmissivity 2 m above the seabed, and is therefore primarily sensitive to silts and clays in suspension. The vertical array of flowmeters allows estimation of bottom stresses, but again no attempt is made to measure profiles of suspended sediment concentration, and bedload transport can be inferred only from time-lapse photographs of bedform migration.

The NOAA-AOML has developed several different systems, each succeeding one more advanced than the previous one. In 1976, a prototype instrument was designed to measure light scattering, transmission and horizontal components of fluid velocity 100 cm above the seabed (Lavelle et al. 1978). During storms on the Inner New York Continental Shelf, this system recorded fluid velocities of over 100 cm^{-1} s and bursts of suspended sediment

concentration of $130 \text{ mg}^{-1}\text{L}$. The second generation system from NOAA-AOML is the profiling-concentration-velocity probe (PCV probe) (Young et al. 1982; Vincent et al. 1982). It uses the 3 MHz downward-looking acoustic concentration meter (ACM) discussed in Section 5.2a, mounted 110 cm above the seabed. This instrument senses and records acoustic backscatter, range-gated at 1 cm intervals from the seabed to 100 cm above the seabed. In addition to the acoustic transducer, the PCV probe includes a vertical array of four electromagnetic current meters located at 15, 60, 100 and 120 cm from the bottom. The lower three meters measure the two horizontal components of the current, while the top one measures one vertical and one horizontal component of the current. The system also includes a wave pressure sensor and a thermistor. The development of this system marks a major advance in the field of direct sediment transport estimation by attempting to measure simultaneous profiles of both velocity and sediment concentration. Nevertheless, although some cross-spectra between suspended sediment concentration and velocity have been calculated (Clarke et al., 1982), there does not appear to have been any attempt as yet to use such data to estimate suspended sediment transport rates directly. This is perhaps because of the major uncertainties inherent in inferring a velocity profile from a few measurements, and in calculating suspended sediment concentrations in the short period bursts of suspension. Vincent et al. (1982) use data from the PCV probe, in conjunction with empirical relations previously derived, to suggest a strong relationship between bedload and suspended load

concentrations, but transport rates are not computed directly.

5.3 INDIRECT ESTIMATION METHODS

As defined in the introduction (Section 5.1), indirect estimates of sediment transport rely on measurements of a time average of sediment transport processes rather than measurements of the transport processes themselves.

Such measurements can be used to calibrate sediment transport models but also provide the data most likely to be of immediate practical use to oil and gas companies and others working on continental shelves.

Of the existing indirect methods, those monitoring the movement of sediment tracers are probably the most useful, and these form the topic of a separate chapter (Chapter 4). In this section we discuss indirect methods which measure changes in the shape of the seabed resulting from local changes in the sediment transport rate i.e. erosion and deposition. First we review methods based on monitoring migration of bedforms, and then discuss methods which monitor net erosion or deposition on the seabed, first by measurements at discrete locations and secondly by repeated, large-scale bottom surveys.

a) BEDFORM MIGRATION

Bedforms are frequently present on continental shelf seabeds where active sediment transport occurs. They exist at a wide range of scales, primarily on sandy seabeds, and are relatively common on the Scotian Shelf (Amos and King, 1984, and Chapter 7).

Where suspension of sediment is weak or non-existent and

where small scale ripples occur, thresholds of sediment motion and qualitative estimates of transport intensity and direction can be obtained from time-lapse photography of the seabed from a tripod-mounted camera (see Section 5.2 c). Quantitative measurements, however, require some estimates of bedform height. Crude estimates can be made by assuming some relationship between ripple wavelength and ripple height. Wilkinson et al. (1983) described a technique in which the shadows cast on a rippled bed by rods held horizontally above the bed are used to estimate ripple heights and, crudely, the two-dimensional nature of the ripples. Surprisingly, very little use seems yet to have been made of stereo-camera photography. Acoustic methods provide the most accurate measurements of small scale ripple motion. Dingley et al. (1977) described a system using a 4.5 MHz acoustic transducer capable of a vertical resolution of 1 mm. The transducer is mounted on an open aluminium framework, 25 cm above the bottom, and is moved horizontally along a rail to scan across the bedforms. Repeated scans then provide accurate measurements of ripple migration. This system has so far been used only in water shallow enough to permit diver deployment and monitoring, but a remotely-driven version is under development at the University of Toronto¹ and this could be the first step towards a fully remote system.

For larger sized bedforms such as sand waves, levelling techniques (e.g. Soulsby et al., 1983) or measurements by divers,

¹ Brian Greenwood, University of Toronto, personal communication.

using lines of reference stakes pushed into the bed across the bedforms (e.g. Langhorne, 1981), can be used in shallow water.

These measurements of bedform migration can be used in two ways to estimate a lower limit of sediment transport. One method estimates the speed of bedform migration by calculation of lagged cross-correlations between consecutive ripple shapes, and multiplies this speed by the volume of the bedform. The second method compares two consecutive surveys of the seabed and sums the net deposition and erosion. Soulsby et al. (1983), for example, found that these two techniques agree to within about 20% for ripples on a sand bank in the English Channel.

Bedform migration is often assumed to be due to bedload transport rather than suspended sediment transport. This interpretation can be based on time-lapse photographs showing the absence of suspended sediment, or on measurements of water current speeds which are below the threshold for suspension (Chapter 2). However, in general, bed-form migration measures the effect on bedforms of the total sediment motion, by bedload or suspended load.

b) POINT MEASUREMENTS OF EROSION AND DEPOSITION

The simplest way to record erosion or deposition at a point is to hammer or jet a marker post into the seabed, and periodically observe changes in the level of the bed from the top of the post. This method has been used extensively in shallow water since the development of scuba diving. Generally an array of marker posts is used, so that measurements of changes over an

area, of a size which can be surveyed easily by a diver, can be obtained.

One variant on this simple technique is the use of a washer placed over the marker rod. This washer drops to the depth of deepest erosion and preserves this depth if subsequent deposition occurs. This is particularly useful since diver observation of the rods is unlikely during storm conditions, when deepest erosion is expected to occur. Greenwood and Hale (1980) describe experiments over a nearshore sandbar which compared the depth of disturbance measured by marker rods and washers with burial depths of fluorescent dye and with epoxy cores which showed lamination structures associated with the erosion depths.

Where observation by a diver is impractical, remote methods of recording changes in the level of the seabed are needed. Marks et al. (1981) described a form of self-recording stake. Rukavina and Lewis (1979) used a downward looking 200 kHz acoustic depth sounder fixed 2 m above the bottom on a frame anchored in the bottom sediment. The sensor monitors changes of seabed height to an accuracy of about 2 cm. Higher frequency acoustic signals and sophisticated techniques for accurate timing of the return pulse can improve the accuracy to about 1 mm. However, the transducer at these higher frequencies will need to be closer to the seabed to prevent excessive attenuation of the acoustic signal by the water. The system described by Dingler et al. (1977), for example, uses a frequency of 4.5 MHz and has the transducer about 25 cm off the bed. The acoustic suspended sediment profiler under development for the Canadian Coastal Sediment Study (see Section 5.2a) has been designed to measure

the location of the seabed using a transducer operating in the MHz range held a metre or so above the bed (Hay & Heffler, 1983).

A recent system, under development at INRS - Oceanologie, Université du Québec (Thibault, 1984) proposes to monitor changes of seabed height by measuring the attenuation of radioactive radiation by sediment between a source and a detector. For example, a radioactive source would be buried beneath the expected level of maximum erosion, and a detector would be held a fixed distance above the source, measuring changes in the attenuation resulting from erosion or deposition.

c) REPEATED BATHYMETRIC SURVEYS

In principle, repeated bathymetric surveys over a region of continental shelf should allow large scale erosion and deposition patterns to be measured. However, the current state of the art of such surveys severely limits the usefulness of this technique.

For accurate measurements of bed levels, accurate position fixing both in the vertical and the horizontal directions are needed. Vertical measurements are limited not only by instrument noise, but also by uncertainties in tide levels and possibly storm surge levels. These uncertainties can be minimized if surveys are done in the vicinity of a fixed structure such as a rig, where absolute water level measurements can be made. However, a vertical uncertainty of, at best, ± 10 cm can be expected, and, away from fixed structures, an accuracy of ± 20 cm is more likely. Horizontal position fixing techniques are also

limited at present to about 5 m relative and 10 to 15 m absolute over a typical survey region. These accuracies would allow detection only of gross erosion or deposition such as that due to the motion of a large scale bedform over a long period.

5.4 CONCLUSIONS

This brief survey shows that instrumentation for accurate direct measurement of suspended sediment transport on continental shelves is within our grasp. The combined acoustic sediment concentration profiler and acoustic Doppler velocity profiler being developed at NOAA-AOML described in Section 5.2, is perhaps the most promising instrument. However, optical techniques also need to be refined to provide sediment concentration profiles for comparison with acoustic methods. Experiments using different techniques for monitoring suspended sediment concentrations should be viewed not simply as intercalibration exercises, but also as attempts to distinguish grain size effects from concentration effects. This could be tried, for example, by using the different grain-size dependence of sensors operating at different frequencies, both optically and acoustically.

A major limitation at present, and perhaps for the foreseeable future, is the absence of any sensors capable of direct measurement of bedload transport on continental shelves. It might be argued conceptually that transport during large storm events, under high currents, will be dominated by suspended load rather than bedload motion, but in the absence of field measurements it is impossible to test or quantify this concept.

Direct measurement of total sediment transport rates will not be possible until direct measurement of bedload transport can be achieved. Bedform migration, where present, will have to be used to estimate bedload transport. Efforts must be made to improve techniques for quantitative measurements of bedform shapes and migration rates at continental shelf depths, perhaps by acoustic techniques since they are less susceptible than optical techniques to the masking of bottom images by suspended sediment.

Field experiments combining the best measurements of suspended sediment transport with accurate bedform migration measurements would be valuable in testing predicted relationships between bedload and suspended load transport (e.g. Vincent et al., 1982). It is clear, however, that such measurements require a high degree of sophistication in sensor design, and considerable care in deployment and data processing. They will be in no sense routine, and will be limited to local, primarily process-oriented, experiments.

For more regional, longer-term measurement of sediment transport, the tracer techniques described in Chapter 4 definitely provide the most satisfactory results.

5.5 REFERENCES

- Anderson, M.G., 1976. An inexpensive circuit design for the acoustic detection of oscillations in bedload transport in natural streams, *Earth Surface Processes*, 1, p. 213-217.
- Amos, C.L. and E.L. King, 1984. Bedforms of the Canadian Eastern Seaboard. - A comparison with global occurrences. *Marine Geology* (In press).
- Barkmann, R., A. Hosseinioun, W. Kroebel and K.H. Mahrt, 1983. A new short path probe sensing the sound attenuation at 10 MHz in situ in the sea for the determination of sub micron bubbles and particulate matter. *Oceans 83, Mar. Sci. Tech. Soc.* 1: 203-208.
- Bartz, R., J.R.V. Zaneveld and H. Pak, 1978. A transmissometer for profiling and moored observations in water. *Soc. Photo-optical Instrumentation Eng., Oceans optix V.*, p. 102-108.
- Bedford, K., R. Van Evra and H. Valizadeh, 1982. Ultrasonic measurement of sediment resuspension. In: *Applying Research to Hydraulic Practice*, P.E. Smith (eds.), ASCE Publishers, p. 575-584.
- Butman, B. and D.W. Folger, 1979. An instrument system for long-term sediment transport studies on the continental shelf. *J. Geophys. Res.*, 84(C3): 1215-1220.
- Butman, B., M. Noble and D.W. Folger, 1979. Long-term observations of bottom current and bottom sediment movement on the Mid-Atlantic continental shelf. *J. Geophys. Res.*, 84 (C3): 1187-1205.
- Cacchione, D.A. and D.E. Drake, 1979. A new instrument system to investigate sediment dynamics on continental shelf. *Mar. Geol.* 30: 299-312.
- Cacchione, D.A. and D.E. Drake, 1982. Measurements of storm-generated bottom stresses on the continental shelf. *J. Geophys. Res.* 87(C3): 1952-1960.
- Clarke, T.L., B. Lesht, R.A. Young, D.J.P. Swift and G.L. Freeland, 1982. Sediment resuspension by surface-wave action: an examination of possible mechanisms. *Mar. Geol.*, 49, 43-49.
- Coakley, J.P., H.A. Saville, M. Pedrosa and M. Larocque, 1978. Sled system for profiling suspended littoral drift. *Proc. 16th Coastal Eng. Conf. ASCE* 2: 1764-1775.

- Dingler, J.R., J.C. Boylls and R.L. Lowe, 1977. A high-frequency sonar for profiling small-scale subaqueous bedforms. *Mar. Geol.*, 24, p. 279-288.
- Downing, J.P., 1981. Particle counter for sediment transport studies. *J. Hydraulics Div., ASCE*, 107(11), p. 1455-1465.
- Downing, J.P., R.W. Sternberg, and C.R.B. Lister, 1981. New Instrumentation for the investigation of suspended sediment processes in the shallow marine environment. *Mar. Geol.* 42, 19-34.
- Drake, D.E., D.A. Cacchione, R.D. Muench and C.H. Nelson, 1980. Sediment transport in Norton Sound, Alaska. *Marine Geol.* 36: 97-126.
- Greenwood, B. and P.B. Hale, 1980. Depth of activity sediment flux and morphological change in a barred nearshore environment. In: *The Coastline of Canada: littoral processes and shore morphology*. S.B. McCann (ed.), Geological Survey of Canada, Ottawa, p. 89-109.
- Hay, A.E. and D. Heffler, 1983. Design considerations for an acoustic sediment transport monitor for the nearshore zone. National Research Council of Canada, Rept. C2S2-4.
- Heffler, D.E., 1979. RALPH a sediment dynamics monitor. Proc. Workshop on instrumentation for currents and sediments in the nearshore zone. Nat. Res. Council Canada, p. 163-173.
- Huntley, D.A. 1982. In situ sediment monitoring techniques: a survey of the state of the art, U.S.A. National Research Council of Canada, Rept. C2S2-1.
- Jansen, R.H.J. 1979. An ultrasonic Doppler scatterometer for measuring suspended sand transport. *Ultrasonics International Conference '79 Proceedings: Graz, Austria*, p. 366-371.
- Langhorne, D.N., 1981. An evaluation of Bagnold's dimensionless coefficient of proportionality using measurements of sand-ware movement. *Mar. Geol.* 43, 49-64.
- Lavelle, J.W., R.A. Young, D.J.P. Swift and T.L. Clarke, 1980. Near-bottom sediment concentration and fluid velocity measurements on the inner continental shelf. *J. Geophys. Res.* 83 (C12): 6052-6062.
- Lees, B.J., 1983. The relationship of sediment transport rates and paths to sandbanks in a tidally dominated area off the coast of East Anglia, U.K. *Sedimentology*, 30, 461-483.
- Lowe, R.L. 1980. Acoustic bedload sensor. Abstract volume,

17th Coastal Engineering Conference, ASCE publ., Sydney.

- Marks, A.J., J.L. Whellock and A.P. Salkfield, 1981. A monitor for measuring the movement of marine bedforms. Electronics for Ocean Technology, Conf. paper, Birmingham, England, 348 pp.
- Richards, K.S. and L.M. Mile, 1979. Problems in the calibration of an acoustic device for the observation of bedload transport. Earth Surface Processes, 4: 335-346.
- Rukavina, N.A. and E.O. Lewis, 1979. A fixed transducer system for recording nearshore profile change. In: Proc. Workshop on instrumentation for currents and sediments in the nearshore zone, N.R.C., p. 61-73.
- Salkfield, A.P., G.P. Le Good and R.L. Soulsby, 1981. An impact sensor for measuring suspended sand concentration. Proc. Conf. on Electronics for Ocean Technology, IERE, London, p. 37-47.
- Sayao, O.S.F.J. and J.W. Kamphuis, 1983. Littoral sand transport, review of the state of the art. Queen's Un. Dept. Civil Engineering Rept. C.E. Res. 78, 62 p.
- Soulsby, R.L., A.G. Davis and R.H. Wilkinson, 1983. The detailed processes of sediment transport by tidal currents and by surface waves. Inst. Oceanographic Sciences, Taunton, Rept. no. 152.
- Thibault, R., 1984. Mise au point d'un appareil automatique de mesures des variations du fond marin. INRS-Océanologie, 31 p.
- Thornton, E.B., 1973. Distribution of sand transport across the surf zone. Proc. 13th Coastal Eng. Conf., Vancouver, B.C., ASCE publ., 2: 1049-1068.
- Thornton, E.B. and W.D. Morris. 1977. Suspended sediments measured within the surf zone. Proc. Coastal Sediments '77 ASCE, New York, pp. 655-667.
- Vincent, C.E., R.A. Young and D.J.P. Swift, 1982. On the relationship between bedload and suspended sand transport on the inner shelf, Long Island, New York. J. Geophys. Res. 87 (C6): 4163-4170.
- Wenzel, D., 1974. Measuring sand discharge near the sea-bottom. Proc. 14th Coastal Eng. Conf., Copenhagen, ASCE publ., 2: 741-755.
- Wilkinson, R.H., A.P. Salkfield and E.J. Moore, 1983. Photogrammetry in sediment transport studies. In Underwater Photography for Scientists. D. George (ed.). Oxford University Press, Oxford, U.K.

Young, R.A., J. Merrill, J.R. Proni and T.L. Clarke, 1982.
Acoustical profiling of suspended sediment in the marine
boundary layer. Geophys. Res. Lett., 9: 175-178.

CHAPTER 6

NUMERICAL MODELLING OF SEDIMENT TRANSPORT

A.J. BOWEN

Department of Oceanography

Dalhousie University

6.1 INTRODUCTION

As has been emphasized in Chapter 2, the prediction of sediment transport requires the description of sedimentary processes at the seabed in terms of the hydrodynamics of the bottom boundary layer. To model sediment transport, therefore, the first requirement is an adequate representation of the hydrodynamic conditions on appropriate time and space scales. The second requirement is an adequate definition of the sedimentary environment, the grain size distribution, availability of material, bottom roughness, bedforms and general bathymetry. The final requirement is a suitable relationship between the current vector $u(x_0, t)$ at some reference height above the bed and the sedimentary response at x_0 , for example in the form of a predictive equation for the total sediment transport.

There is an obvious vagueness about these requirements. What are appropriate time and space scales, for example? In

trying to address this question, it becomes apparent that a single, universal model of sediment transport is not a practical goal. There are an infinite set of possible models whose adequacy or suitability depend not only on the nature of the particular problem but also on the availability of appropriate data. If actual measurements of sediment transport, for various wave conditions and ambient currents exist, a simple empirical correlation may provide an adequate prediction (Thorn, 1979).

Conversely, the lack of a complete data base, may also significantly influence the modelling procedure. A modeller lacking wave data may:

- assume wave effects are small (Gadd et al, 1978; Heathershaw, 1981)

- compute theoretical wave influences for some conceptual waves using a simple model such as Bijker (1967) (Heathershaw, 1981, Lees, 1983)

- adjust the threshold of movement, drag coefficient or bottom roughness to try to compensate for the presumed wave activity (Vincent et al., 1983).

This example is particularly relevant because orbital velocities associated with surface waves are not well resolved by traditional oceanographic current measurements. As a result, reliable wave data is not available for a number of important field experiments (Gadd et al., 1978, for example). The assumption that wave effects are small may be reasonable for particular periods during these experiments, but there is increasing appreciation of the role that even small orbital

velocities may play in enhancing the effective bottom stress. However, the adjustment of the boundary layer parameters to compensate for the absence of wave data takes us even further from the idea of a universal model; a parameter which might have a universal value (Fig. 2.1) becomes another empirical input.

In practice, modelling exercises are the result of a number of subjective decisions about the relative importance of the various possible inputs and assumptions. The nature of these decisions depends very strongly on the particular project and it is therefore useful to briefly review the range of problems that may be of interest. In Section 6.2, the motivation for modelling is discussed, together with a general discussion of space and time scales. Section 6.3 considers the modelling of sediment movement at a point; this leads to the concept of the ideal experiment. In 6.4 we consider two-dimensional models, introducing the possibility of modelling erosion and accretion and consequently models for the formation of sedimentary features such as sandwaves and sand banks.

These three sections provide the background for the discussion of models of Sable Island Bank in Section 6.5. Present practice is then summarized in 6.6 and future research needs are considered.

6.2 MODELLING: MOTIVATION, SPACE AND TIME SCALES

a) PROBLEMS OF SEDIMENT TRANSPORT

The fundamental questions that a sediment transport model might address in a study of an area such as the Scotian Shelf are relatively few. We might ask

- i) Does sediment of a given size move?
when does it move? how often?
- ii) How does it move?
suspended load or bed load?
bed forms?
depth of movement?
- iii) What is the rate of movement, $q(x,t)$?
total, suspended or bedload?
transport of a particular size fraction?
- iv) What are the rates of erosion or deposition?
total?
as a function of grain size?

Space or time scales are implicit in most of these questions. For (i) we could ask if the sediment is a relict geologically, never moving under present conditions. This focusses attention on extreme conditions which occur infrequently, requiring estimates of the statistics of the velocity field over long periods of time. It is rather unlikely that direct observations of the critical conditions will be available. In contrast, a study of suspended sand transport in strong tidal currents may totally ignore the effects of extreme events; they may be too infrequent to influence the overall transport patterns. Here the critical factors are the asymmetry of the tidal currents (the contrast between flood and ebb), the spring-neap cycle and the short term changes in the wave field, all of which might be measured directly (Thorn, 1979). These two examples illustrate the change in the type of problem that would arise if one moves from deep areas on the Scotian Shelf into the Bay of Fundy. They also emphasize the degree to which different problems stress different areas of our physical understanding of sediment dynamics. An estimate of the threshold of movement

requires calculating only the critical stress, described for example by the Shields' curve (Figs. 2.1, 2.2), transport relations are not needed. For suspended load transport in an energetic environment the critical stress is likely to be irrelevant but the precise form of the transport formula is critical.

The range of problems is sufficiently large that we may expect a number of possible models, each addressing a different topic. However even within a particular problem area there are requirements for studies on different space and time scales, which may profoundly alter the actual modelling procedure.

b) SPATIAL SCALES

The most obvious modelling situation is the case in which all three factors, hydrodynamics, sedimentary environment, and sediment movement are measured, or predicted, at a single point. If all three are measured, then data are available for scientific studies, model calibration or simple modelling by extrapolation. However, a definition of the sedimentary environment necessarily involves horizontal length scales, the scale of any bedforms for example. This, in fact, reflects a serious problem; the difficulty is one of interpreting a single point measurement, however accurate. This is most clearly seen when an instrument is deployed in a dune field, among large sand waves, or in other complex topographies; the observed values of both water velocity and sediment movement will depend on the location of the instrument relative to the topography. Unfortunately, unless a very large number of instruments are deployed, it is necessary to

assume that measurements at one particular point are reasonably representative of conditions over a significant area of seabed. There is consequently a strong experimental bias towards areas that do not appear to be too complex topographically.

In practice, direct measurements of sediment transport at a particular point are only possible in energetic environments totally dominated by transport in suspension (Chapter 5). Even then, there are very significant practical problems, particularly in measuring concentration near the bed. However, as has been seen in Chapter 4, the most promising methods for measuring total sediment transport on the continental shelf are tracer techniques. As the tracer spreads out during an experiment, its movement necessarily reflects the conditions within a larger and larger area. In general this is advantageous; it is impractical to model or measure variations in hydrodynamic conditions on scales of metres, or even tens of metres, except in specially designed experiments.

However, the problem of spatial resolution necessarily arises in the context of (iv), the prediction of erosion or accretion. If the transport rate $q(x,t)$ is known as a function of position and time, then the rate of deposition $R(x,t)$ is, formally

$$R(x,t) = - \nabla \cdot q(x,t) \quad (6.1)$$

or
$$R(x,t) = -(\partial q_x / \partial x + \partial q_y / \partial y)$$

where q_x , q_y are the components of q in two horizontal directions (x,y) . To resolve these derivatives for any particular lengthscale L , at least four estimates of q are required, giving a maximum grid spacing of $L/4$. To resolve the dynamics of a 400 m

sand wave a grid scale of 100 m is therefore required. The modelling of large areas on this scale is not practical but a finer grid might be inserted within a larger coarser model to resolve fractures of particular interest (Pingree, 1978).

c) TIME SCALES

A schematic idea of the time scales of variation of the velocity field on a shelf is shown in Fig. 6.1. For a storm-dominated shelf environment, such as the Scotian Shelf, interest in low frequencies is focussed on the occurrence of the severe conditions associated with winter storms or summer hurricanes. Engineering design is related to storms of long return period, the ten, fifty or one hundred year storms, for which direct observations are likely to be either absent or sparse. A similar interest in long-term extremes in the sediment movement is complicated by the need to consider waves, tides and wind-driven currents simultaneously, and consider them over a wide area of shelf. It is inevitable that extreme conditions will be experienced at different places at different times; a storm that produces extreme conditions on one side of Sable Island may, for example, be relatively unimportant on the other. This widens the range of conditions that may have to be examined but the actual modelling process will be to reproduce each storm separately. An important class of models is therefore one that runs for a relatively short time, a few days at most, with wind, tide and wave input for the appropriate extreme conditions.

A rather different model is needed if the primary interest is in the mean transport paths over a long period of time. Hill

SHELF CURRENTS

TIME SCALES OF VARIATION	WIND DRIVEN	WAVES	TIDES	DENSITY DRIVEN	DEEP OCEAN
Secs		Orbital Velocity			
Hours	Surges	Longshore and Rip Currents	Tidal Currents	Internal Tides	
Days Weeks	Upwelling Shelf Waves	Drift Velocity			
Months	Circulation		Spring-Neaps	Estuarine Circulation	Rings Eddies
Seasonal	Seasonal Patterns	Hurricanes Winter Storms	Low frequency variability	Seasonal Run-off.	Ocean Currents
Annual	Winter	Ice		Insolation	
Long Term	Extreme Storm	Conditions			Oceanic Circulation

Fig. 6.1 Contributions to the velocity field on a continental shelf

and Bowen (1983) suggest a general pattern of movement off the Scotian Shelf on to the slope. This leads to interest in the processes which tend to maintain Sable Island, or any other specific feature on a shelf. Investigation of such very long term trends is of considerable geological interest but probably not a priority for engineering studies, fortunately perhaps, as running a model for long periods, using realistic inputs, presents serious practical difficulties. To look at geological timescales some type of stochastic modelling is clearly necessary, where the occurrence and intensity of various events is expressed in terms of return periods. Suitable combinations of events might then provide an estimate of the patterns of transport on geological time scales.

In practice, relatively long runs of a deterministic model will probably be associated with experimental data, for example, with a tracer experiment running for periods of months. In this case the primary interest would be movement at one point, or at least within a small area. Nevertheless, prediction of the wind driven bottom currents still requires a large scale modelling exercise and it would clearly be necessary to monitor the hydrodynamic conditions for the whole period of a tracer experiment. There is the additional constraint that long term trends may be influenced by other oceanic processes, (general shelf circulation, internal tides, etc.) which provide a day-by-day input, negligible during a storm event, but perhaps significant in the long term. Modelling all these separate oceanographic processes would be a truly formidable undertaking. Direct monitoring of the hydrodynamic conditions near the sea bed

over a timescale of some months should provide further insight as to the relative importance of these processes. However, much longer deployments may be necessary to identify long term variability (seasonal circulation, intrusion of Gulf Stream rings) as suggested in Fig. 6.1.

6.3 MODELLING SEDIMENT TRANSPORT AT A POINT

a) INPUT PARAMETERS

To focus attention on the specific inputs required for modelling it will be useful to look at two extremes, the experiment we have just been discussing, the "ideal" experiment for which detailed measurements of the hydrodynamic conditions, the sedimentary environment and the sediment response are all available, and the extreme storm for which no directly relevant data are available, only the general characteristics of the particular meteorological situation are known.

In an ideal data set it would be possible to examine the sediment response, including changes in the sedimentary environment itself, as a function of flow conditions. This would lead to an empirical understanding of the nature of the sediment movement and evaluation or calibration of the sediment transport formulae discussed in Section 2.3.

For the extreme storm, parameter values will have to be assumed or predicted. Assumptions, for example, will have to be made about the initial state of the sedimentary environment and the relevance of transport formulae; hydrodynamic conditions will have to be predicted by appropriate models.

In either situation, ideal experiment or extreme storm, two

questions arise. What is needed in the way of input? How can this be obtained?

b) HYDRODYNAMICS

In almost every model proposed, hydrodynamic conditions are defined by the velocity vector $u(x_0, t)$ at a standard height above the sea bed (usually 1 m). In principle this velocity should include all the processes outlined in Fig. 6.1. In practice, typical measurements of ocean currents do not resolve the wave field. Ideally, a current meter has a sampling strategy that avoids aliasing wave motion into the record, but storage problems normally preclude the recording of any wave information obtained. However, apart from the waves, all the phenomena included in Fig. 6.1 are, in principle, observable if not necessarily identifiable. Wave orbital velocities can be roughly estimated from surface data, often obtained with Waverider buoys for example, but directional information is then lost. As the predominant wave direction relative to the current is a significant parameter in recent wave/current interaction models (Grant and Madsen, 1979) direct measurements of the orbital velocity near the bed are certainly desirable. As was mentioned in Section 6.1, wave data are not available in a significant number of the experimental data sets in the literature (Gadd et al., 1978; Heathershaw, 1981; Lees, 1983).

One of the reasons for this lack of wave data is that there has been a noticeable emphasis on measuring or modelling sediment transport in areas of strong tidal currents, as in the case of both Heathershaw and Lees. In many areas there is strong

qualitative evidence that the sedimentary regime is dominated by tidal forcing. However, this does not necessarily mean that the transport measured at a point is totally independent of wave conditions.

While, in practice, wave measurements have been rather neglected there is, in principle, no real difficulty in making reasonable wave observations. We can think in terms of measuring $u(x_0, t)$ at a point over all appropriate time scales, given adequate resources. However, extending a measurement program to define the velocity field in both time and space presents a truly formidable problem, to which we will return in Section 6.4.

In the absence of direct measurements, hydrodynamic conditions will either have to be predicted or modelled. To review the difficulties involved, we need to look at some of the major components in Fig. 6.1.

i) Surface waves.

The forecasting of surface waves is a topic frequently reviewed (Baird and Readshaw, 1981; Resio, 1982) reviews often being triggered by practical problems arising from disasters such as the loss of the Ocean Ranger. The engineering and operational needs for wave data have resulted in an extensive data base and considerable experience in wave forecasting. This has involved predictions of the pattern of wave motion over shallow areas, such as Sable Bank, and sophisticated models are available (Jonsson and Wang, 1980; Seaconsult, 1983).

There are undoubtedly technical problems, involving wave dissipation and scattering for example, and practical

difficulties in dealing with the range of frequencies found in real wave spectra. However, this is not primarily a problem of sediment transport. Models that prove satisfactory for engineering design should provide a reasonable wave input to models of sediment movement.

A much less tractable problem is the prediction of currents driven by wave dissipation. The flow pattern that would be described as nearshore circulation, longshore and rip currents on a beach, has a shelf analogy. In severe conditions the surf zone encompasses large areas of the shelf. In examining the somewhat simpler problem of wave dissipation by bottom friction alone. Dolata and Rosenthal (1984) present calculations for an idealised coast with longshore currents of order 0.3 m s^{-1} extending 25 km offshore.

ii) Tides.

Tidal currents are predictable from long-term current observations. For example, predictions for Grand Mahan Channel and Great Bras d'Or are given in Volume 1 of the Canadian Tide and Current Tables. Estimates of regional patterns of tidal currents are also available from a variety of numerical models of shallow seas (Greenberg, 1983, Davies, 1983), generally in the form of a depth averaged current over a topography smoothed on the grid scale of the model (usually at least several kilometers). In practice, the tidal current near the bed may be significantly perturbed by complex topography, such perturbations being a possible mechanism for the generation of sand waves (Cartwright, 1959). This again raises the problem of spatial scales discussed in Section 6.2; any estimate of the modelling

effort required must very carefully consider the spatial resolution involved. This argument applies, however, to any hydrodynamic modelling and, overall, the uncertainties in the prediction of tidal currents are likely to be small compared to those associated with other phenomena.

The existence of two and three dimensional models of shallow seas and shelves allows the computation of the steady tidal residual currents generated by non-linear processes (Zimmerman, 1979; Tee, 1980). The patterns of the residuals appear interesting but the absolute values are often small, a few centimeters per second. Fig. 6.2a shows results from a three dimensional model of the North Sea of rather coarse grid resolution (Davies, 1983). However strong tidal residuals may be generated in regions of large tides (Tee, 1982) and by the interaction of tides and offshore topography, a counter-clockwise circulation being found around banks in regions of strong tidal currents (Huthnance, 1973, 1981; Loder, 1980). These patterns are reasonably well described by models with adequate spatial resolution, but the details of the flow near the bed, particularly the cross-isobath flow seem very sensitive to the modelling assumptions.

iii) Meteorological Forcing.

The two and three dimensional shelf models are designed to handle meteorological forcing, wind and perhaps pressure, as well as tidal forcing. Patterns for typical forcing fields can be derived. Fig. 6.2b shows mean sea-bed currents for a typical winter (from Davies, 1983). The definition of boundary

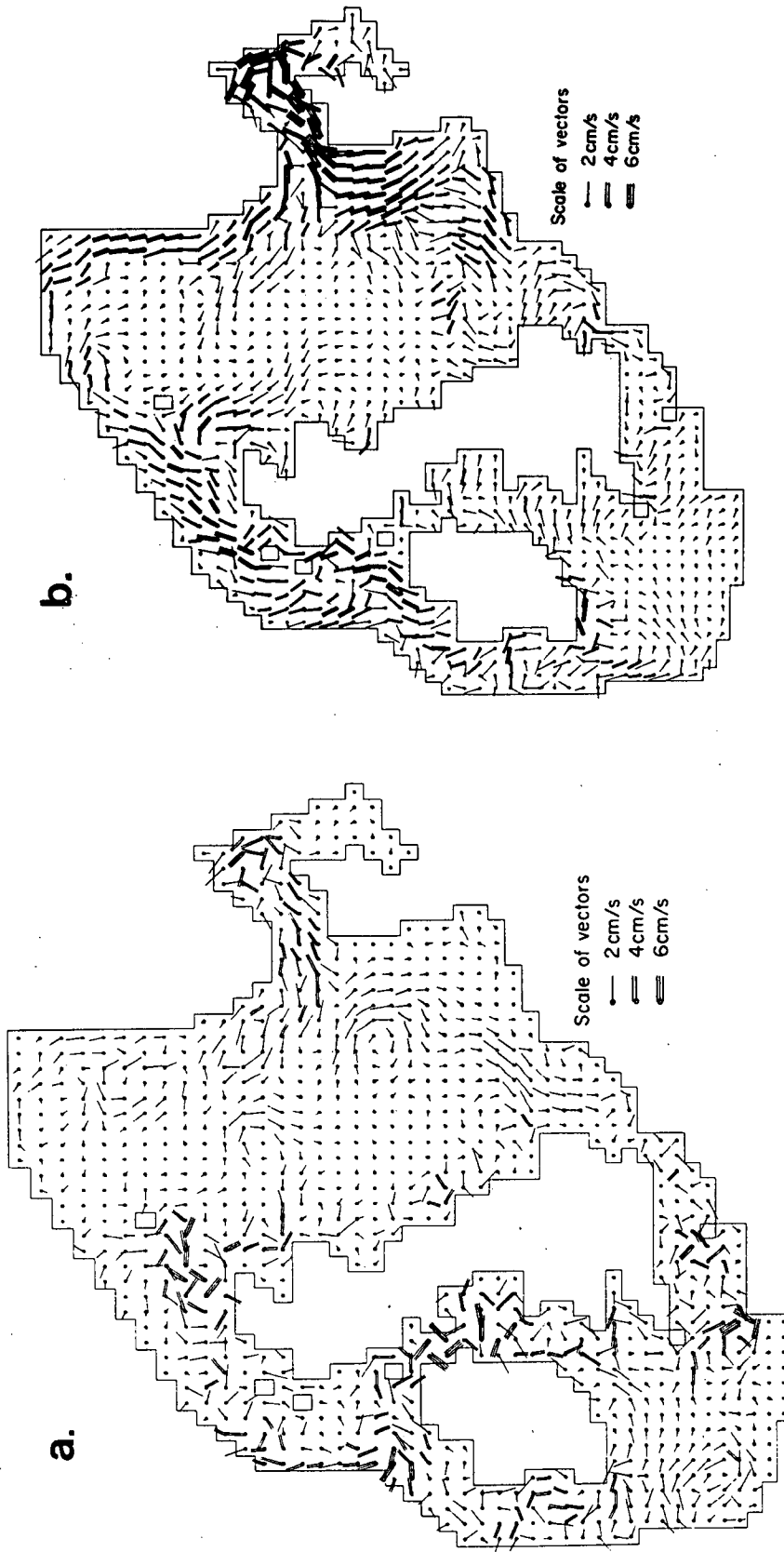

Fig. 6.2 Current patterns at the sea bed from the output of a three-dimensional numerical model. (a) Tidally driven residual currents. (b) Meteorologically induced currents for the period December to February (after Davies, 1983).

conditions in this type of model is difficult. Davies has taken the shelf edge as his outer boundary to minimize the problem. However, it is unlikely that small shelf areas can be studied in isolation. A model will have to include a large area of the shelf, even if the area of particular interest is small. While it may be possible in principle to use a coarser grid resolution on the areas of less immediate interest, this requires a more sophisticated modelling scheme.

There is an interesting contrast here between the direct measurement of currents, where it is difficult to adequately cover a significant area, and the prediction of wind driven currents where it is difficult to compute the current velocity at a particular point without solving the problem over a wide area.

There is no fundamental difficulty in using models providing results such as those shown in Fig. 6.2 to compute the response of the sea to extreme storms. Tryggstad et al. (1983) have looked specifically at extreme bottom currents at two sites in 70 m depth in the North Sea to compare the observed data with model results. Predictions from a two dimensional model using a modified form of the Leendertse finite difference scheme (Leendertse, 1967) were in reasonable agreement with the residual currents observed. Prediction of extreme currents seems therefore to be a realisable goal but requires modelling in the scales indicated by Fig. 6.2. An interesting complication was the anomalously high values of tidal currents recorded during the storm. Tryggstad et al. suggest that the Aanderaa RCM-4 current meters, moored 3 m above the bed, were affected by wave pumping of their rotors, implying significant wave orbital motion at

these depths.

The prediction of the other processes indicated in Fig. 6.1 present major difficulties in scientific understanding, in the data bases required, and in the effort that would be involved in constructing an operational model. In practice, attention is likely to be concentrated on those phenomena that long-term current data from a site show to be necessary for the first order description of the velocity field. Some relevant statistical parameters, such as the typical mean currents, may be extrapolated from the existing data base. Such analysis requires some care if it is to be consistent with the idea that storms are discrete events which are included separately.

c) SEDIMENTARY ENVIRONMENT

The input data on the local environment required for sediment transport modelling can be grouped into four, somewhat overlapping categories:-

i) The grain properties: grain size and density, grain size distribution, settling velocity and settling velocity distribution.

ii) The distribution of grain properties in space: in suspension, moving as bed load, as a function of depth in the sediment, total depth of sediment.

iii) Bottom roughness: surface grain size, local sedimentary structures, biological structures and activity, drag coefficient.

iv) Regional patterns: position relative to large scale features, (bedrock or sedimentary) regional slope of the sea bed.

A knowledge of the grain properties is central to the

problem as almost all predictive formulae for sediment movement require a definition of either the sediment grain size and density or the settling velocity (primarily a function of grain size and density). These formulae were, however, derived from data from laboratory experiments which were specifically designed to study the behaviour of very well sorted sand, where a single grain size represents all characteristics of the material; in threshold movement, bed load and suspension, grains are moving relative to and in interaction with only material of the same size. In a real situation, sediment consists of a mixture of grain sizes and, possibly, densities. On the Scotian Shelf, King (1970) recognized two shelf-edge surficial sand and gravel lithologies. On the banks, relatively well sorted sands and gravels were found, while saddle areas were covered with relatively poorly-sorted sediments of similar mean size. In the geological literature these grain size distributions are interpreted in terms of hydraulic processes (Middleton, 1976; Hill and Bowen, 1983). However, most of the sediment transport formulae can not be logically recast to include grain size distributions. To use these results a single mean size must be assumed; Vincent et al. (1982, 1983), for example, take 530 μ m as representative of the inner shelf off Long Island.

However, simple physical arguments would suggest that hydraulic processes will sort sediments, and such ideas are central to the geological interpretations of grain size distribution. Direct observations of material in suspension show that while the trends predicted by simple models are

quantitatively correct, the actual behaviour is complex. Lees (1983), for example, notes that

"these grain size distributions serve to emphasize the complexities of suspended sediment mechanisms and show in particular that material in suspension does not necessarily bear a simple relationship to that on the seabed beneath it. Furthermore it is not clear what happens to the transparent, subangular grains of quartz ($d_{50} = 2.50, 180\mu\text{m}$), seen moving southwards in the flood tide, but absent in the ebb."

In extreme cases it is obvious that the material in suspension is totally unrelated to the material on the bed. For example, Amos and Greenberg (1980) model the transport of silt in Minas Basin, including large areas where the actual seabed is a gravel lag overlying mud.

Overall, the choice of the grain size representation is likely to be a critical decision in any modelling program. Taking the average between a "relict" gravel and a mobile silt does not make much physical sense. Other measures contain similar, but more subtle difficulties. Bagnold (1966) suggests defining the settling velocity of a mix of grain sizes by

$$\bar{w} = \frac{\sum p_d w_d}{\sum p_d} \quad (6.2)$$

where w_d is the settling velocity, and p_d is the percentage composition of a particular size fraction of diameter, d . This weights the values of \bar{w} towards large sizes. Equation (6.2) is easy to apply using actual measurements of the size distribution of the suspended load, but much more complex if the distribution

has to be predicted, which implies a multiple grain size model.

The observed distribution of grain size, item (ii), has already been touched upon in the discussion of the contrast between bed load and suspended load, and the gravel-mud layering in Minas Basin. The depth of material available for movement is clearly an important parameter. Substrates of bedrock, gravel, clay or indeed any material significantly different from the surface layer complicates the modelling of erosional sequences by controlling the total sediment supply or the supply of material of a particular size.

The third factor required is information on the bottom roughness. A number of models require this as a specific input. Heathershaw (1981) models the bottom velocity profile $u(z)$ as

$$u(z) = \frac{u_*}{k} * \ln\left(\frac{z}{z_0}\right) \quad (6.3)$$

where u_* is the friction velocity, k von Karman's constant and z_0 the roughness length. In Heathershaw's data long term velocity measurements were available only at 2 m above the bed. The value of u_* obtained was, therefore, strongly dependent on the assumed form of z_0 . If we compare this to a classic drag coefficient formulation, with coefficient c_d ,

$$u_* = (c_d)^{1/2} u(z_{ref}). \quad (6.4)$$

it is clear that the varying roughness lengths are equivalent to a variable drag coefficient. Fig. 6.3 indicates typical values used for z_0 and the dependence of the value of the threshold velocity for a given grain size d on the choice of z_0 . As there is relatively little observational evidence for the systematic variation in c_d implicit in (6.3), the rationale here is, in

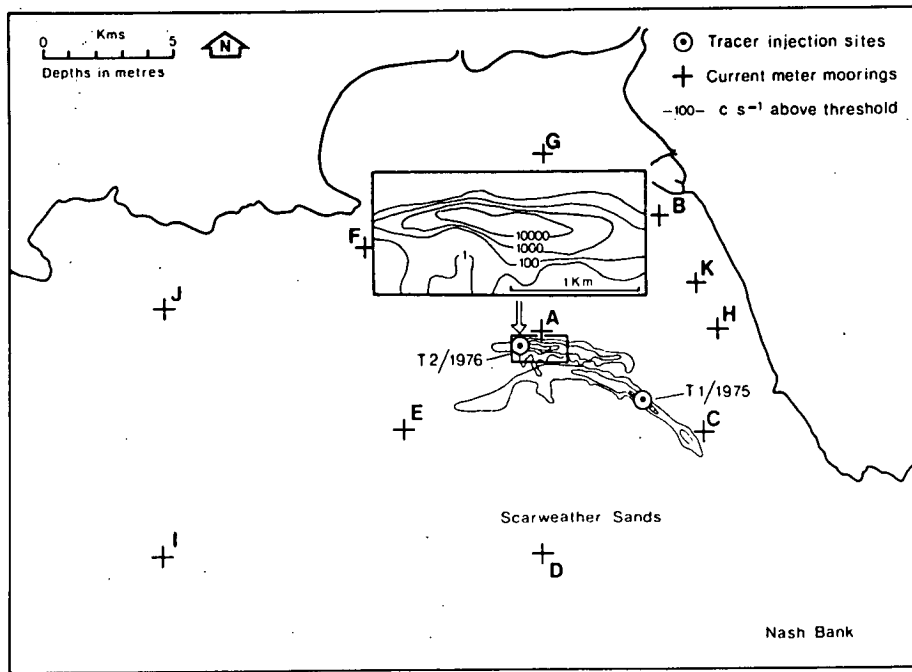

A. Roughness length (z_0) values used for comparisons and predictions of bedload transport rates in Swansea Bay

Location	Sediment	Possible bedform	z_0 (cm)
D, H, K	sand or gravel	rippled or irregular	0.5
C, E, F, I, J	sand/gravel or gravel/sand	irregular	0.1
A, B, G	muddy sand or sandy mud	planar	0.05
	mud	planar	0.01

B. Threshold velocities (U_{CR}) calculated from Yalin's (1972) modified Shield's (1936) curve for different grain sizes and roughness lengths (U_{CR} is the critical velocity at 100 cm above sea-bed)

z_0 (cm)	U_{CR} ($z = 100 \text{ cm}$) (cm s^{-1})				
	d (cm)	0.01	0.02	0.05	0.01
0.01		30	30	36	50
0.05		25	25	30	41
0.10		23	23	27	37
0.50		17	17	21	29

Fig. 6.3 Tracer experiments in Swansea Bay, U.K. Location map and examples of roughness lengths (A) and threshold velocities (B) assumed for the prediction of bedload transport rates (after Heathershaw, 1981).

effect, to partition the stress into skin friction and form drag with the value given by (6.3) being an estimate of the skin friction felt by the grains at the boundary (Chriss and Caldwell, 1982).

More detailed understanding of the relationship of bottom conditions to the flow regime on the continental shelf is being gained by including time lapse photography on bottom sensor arrays. The limited spatial view in such experiments concentrates attention on the occurrence and evolution of small bedforms, such as ripples. Historically, geologists have used flume data to estimate the bottom stresses associated with various types of bedform. This becomes questionable when large waves and strong tidal currents co-exist. Very pragmatic assumptions may be necessary until the relationships between bottom roughness, bedforms, and sediment movement is better defined. This is an active area of research with people expressing very different ideas on these relationships (Dyer, 1980; Grant and Madsen, 1979).

In practice, the changes in the first three parameters defining the sedimentary environment are difficult to predict. In the absence of direct observations, simple models will have to assume that the sedimentary parameters are adequately defined by the historical data base.

The regional morphology, item (iv), is a quantity that is readily measurable but only known in very general terms for the shelf as a whole. A point estimate of sediment transport does not provide information on movement of features such as sand

waves and although a two-dimensional model of adequate resolution should predict changes in regional morphology, equation (6.1), observational confirmation would be essential. There are currently no operational models that update the topography and recompute the sediment fluxes in the new geometry. This would be necessary to follow any changes that significantly alter the local hydrodynamic conditions.

d) SEDIMENT TRANSPORT RELATIONS

Most of the basic ideas on the physics of sediment movement relevant to modelling have been introduced in Chapter 2, and the subject of the sediment transport relations has been dealt with at length in Section 2.3.

Heathershaw (1981), in the analysis which resulted in Fig. 6.4a, considered five equations for sediment transport, three bedload, Einstein (1950, 1964), Bagnold (1963, 1966) and Yalin (1963), and two total load, Ackers and White (1973) and Englund and Hansen (1967). At the shallow water site T1 all models except Yalin's gave similar values that were in reasonable agreement with the tracer results (which are net transport over a number of tidal cycles). However at T2, the deeper site, the predictions scatter over two orders of magnitude with only Bagnold's prediction being in the same ballpark as the measurements. Heathershaw discusses at some length the accuracy of these predictions, emphasizing the fact that they involve products of the friction velocity and the excess stress, equation (2.8) for example, quantities not easy to estimate.

Heathershaw concluded that his work supported the use of a modified Bagnold equation, at least for tidal environments on a

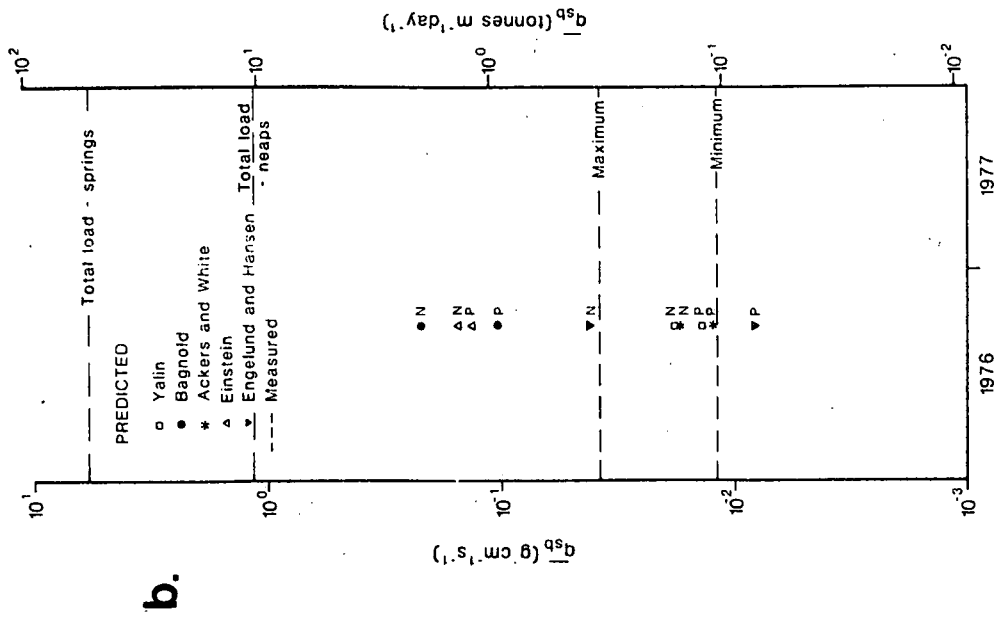

b.

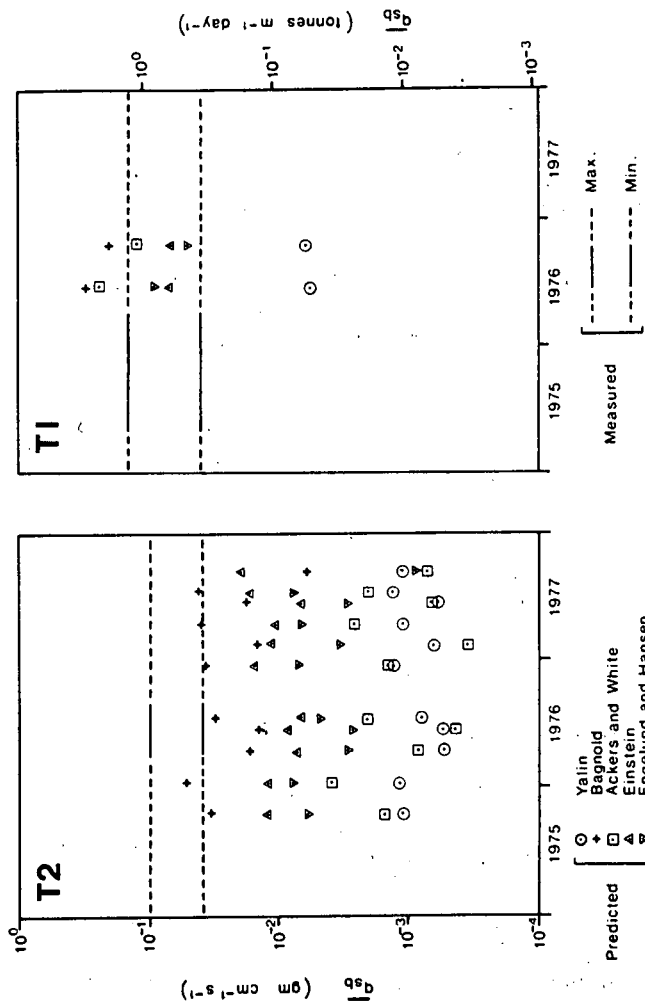

a.

Fig. 6.4 Comparison of measured and predicted net bedload transport rates (q_{sp}). (a) Maximum and minimum measured rates derived from radioactive tracer experiments at T_2 and T_1 (see Fig. 6.3) (after Heathershaw, 1981). (b) The comparison of measured net transport with predictions for two stations N and P in the general area of the tracer experiment (after Lees, 1983).

shelf. This fits with Gadd et al. (1978) and would leave us with a reasonable working hypothesis if Lees (1983), working in the same Institute on the same type of problem, had not come to very different conclusions. In her case, Yalin's model seems to provide the best prediction (Fig. 6.4b).

In trying to assess the validity of any modelling experiment one very obvious difficulty is that the description of a model as "Bagnold" or "Einstein" is more a convenience than a definition. Bagnold himself has many versions of his various models. As Heathershaw puts it, his work "supports the use of Gadd et al.'s (1978) recalibrated and restructured version of Bagnold's (1966) equation." The Einstein equation used by Heathershaw was also recalibrated by Gadd et al. using flume data, not field data.

The first uncertainty therefore in assessing the adequacy of a formula is the precise nature of the expression, particularly the values of the constants. The second question is the assumptions in the hydrodynamic data. Neither Heathershaw nor Lees had wave data, and clearly did not think it was essential to hindcast for the appropriate area. However, Heathershaw has produced a diagram of the expected increase in bottom stress and bed-load transport for water depths of 12m (Fig. 6.5). This very graphically illustrates the critical effect of wave activity on the threshold of movement. It immediately suggests that a shelf model that includes threshold effects but ignores waves is highly suspect. Even at high velocities wave effects are significant, factors of two appear rather trivial in the immense range of transport rates covered by Fig. 6.4. Note that the typical

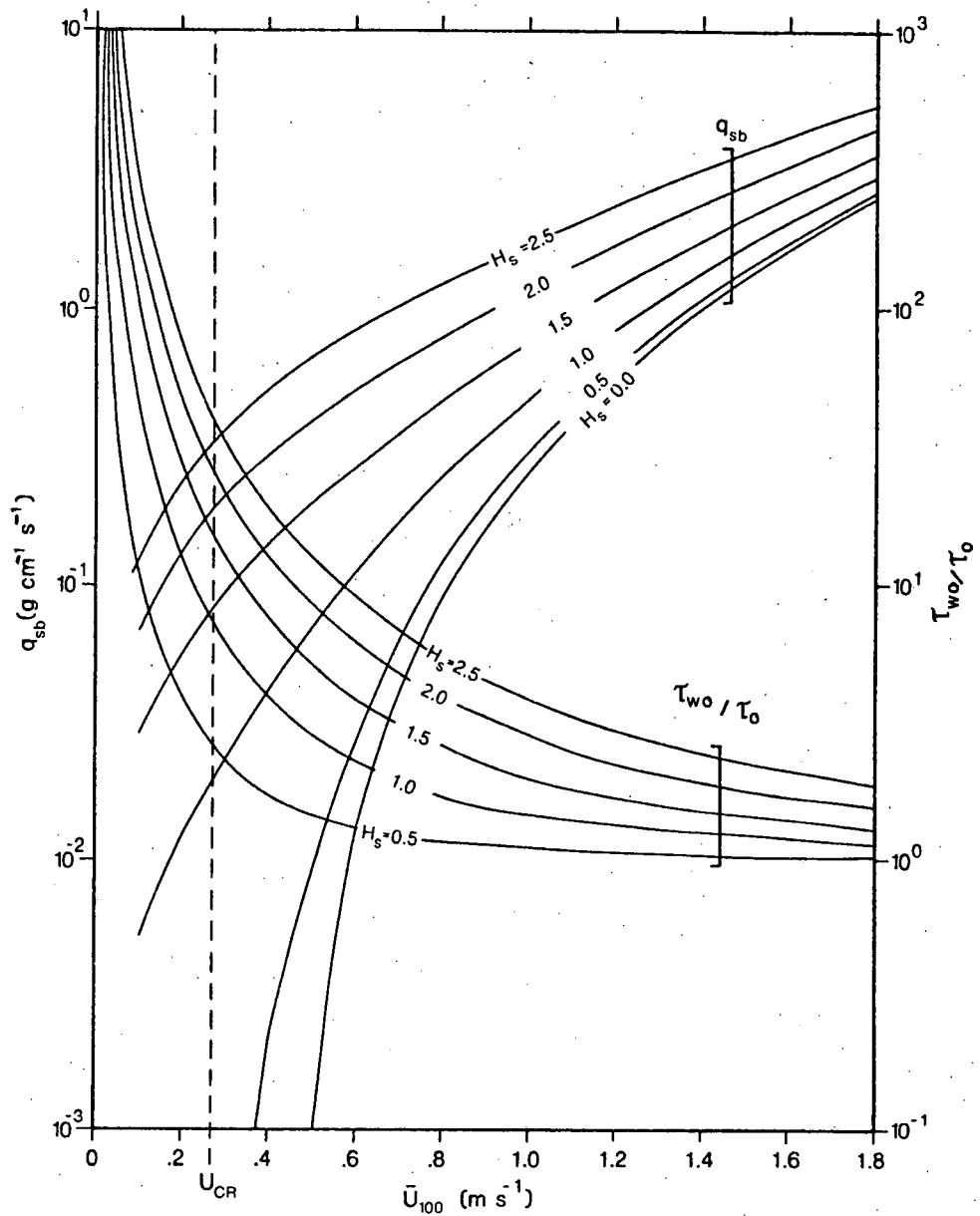

Fig. 6.5 Effect of waves on sediment transport, using Bijker's (1976) magnification factor (τ_{wo}/τ_o), to illustrate effect of increasing wave height (H) on bedload transport rates (q_{sb}), as function of current at height 100 cm above sea-bed (\bar{U}_{100}). The calculations have been carried out for waves of 6 sec period and water depth of 12 m, with roughness length of 0.05 cm, typical for fine sand (after Lees, 1983).

values for the net transport given in Fig. 6.4 are $0.1 \text{ gm cm}^{-1} \text{ s}^{-1}$. These are of the same order as those observed by Gadd et al. (1978) on the U.S. East Coast.

These three examples are the only data sets in which tracer experiments provide estimates of sediment transport rate that are independent of other measurements. As none of these experiments obtained wave data, they do not provide a critical test of any model expected to predict sediment transport in extreme conditions on the Scotian Shelf.

In energetic environments, material in suspension may be sufficiently dispersed upwards into the water column that it can be sampled with reasonable confidence. Under these conditions the thin layer of relatively slow moving bed load is assumed to contribute relatively little to the total transport. The product of the observed velocity and concentration may then provide a good estimate of the total sediment transport (see Chapter 5). Observations are most easily made in strong tidal currents. Fig. 6.6 illustrates two such data sets, which show reasonable agreement.

Lees (1983) finds the suspended transport q_{ss} to be given empirically by

$$q_{ss} \sim u_*^{2.8} \quad (6.5)$$

Thorn (1979) has data from very shallow water and significant wave activity. Regarding the orbital velocity v' as a separate variable he finds

$$q_{ss} \sim u_*^{2.7} \quad (6.6)$$

where u_* is the friction velocity generated by the tidal stream. This then leads to a multiplier M (Fig. 6.6) which accounts for

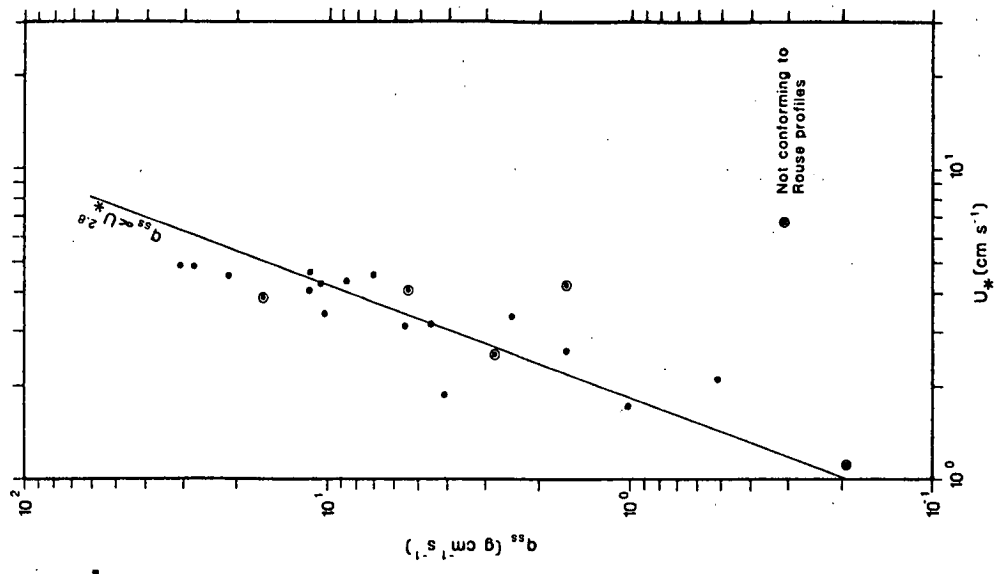

b.

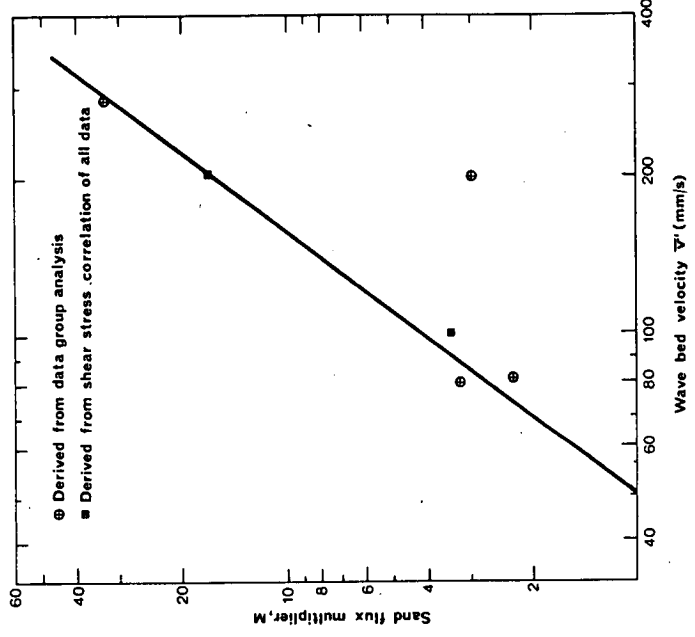

a.

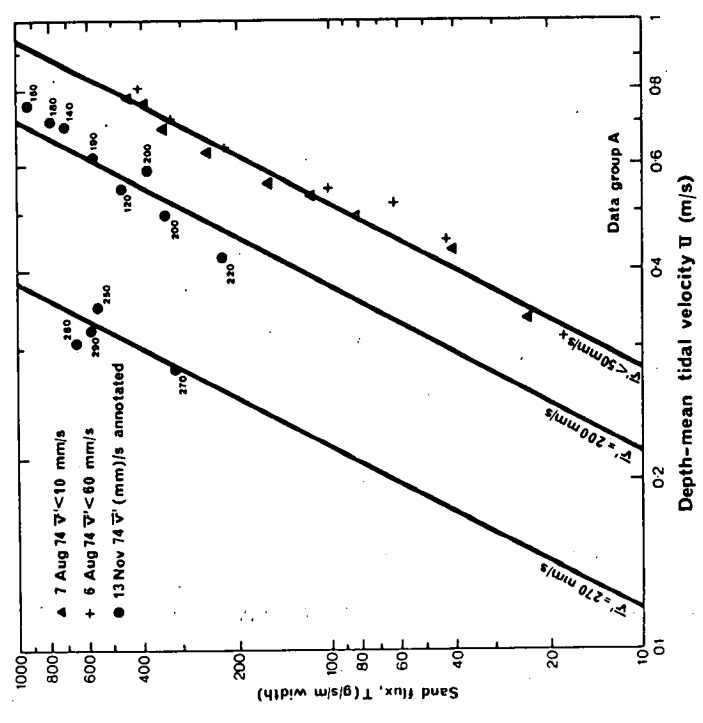

Fig. 6.6 Variation of total suspended sediment transport rate. (a) Transport of sand as a function of tidal velocity (u) and wave orbital velocity at the bed (\bar{v}'), (after Thorn, 1979). (b) Suspended transport as a function of u_* in a tidal environment (after Lees, 1983).

the additional sediment transport associated with wave activity, a result analogous to Fig. 6.5 but purely empirical. As can be seen in Fig. 6.6, in Thorn's environment sediment transport may be very strongly enhanced by wave action with orbital velocities of 0.20 m s^{-1} leading to a 10 to 20 times increase in suspended sediment flux.

These results are extremely valuable and seem to vary consistently within the parameter ranges observed. The difficulty is in extrapolating this type of result to extreme conditions, that is, to small currents and big waves for example.

Another difficulty is in modelling the intermediate stages of flow, particularly the transition from bed load to suspended load. A number of possible models have been outlined in Section 2.3. The central problem seems to be obtaining satisfactory understanding of the factors that control the concentration of the suspended load close to the bed (Smith, 1977).

The general conclusion, having looked at the bits and pieces available, is that a reasonable first attempt could be made to model the movement of a particular grain size in a particular type of environment. Amos and Greenberg's (1980) model of the transport of fine material in Minas Basin falls nicely into this category. However, if one needs a model for a shelf, ranging in depth from zero to hundreds of meters, for a range of grain sizes, and a range of hydrodynamic conditions from "normal" to extreme storm, the problem becomes exceedingly complex.

6.4 TWO-DIMENSIONAL MODELS

a) DIAGNOSTIC MODELS

The basic building block of two-dimensional models is the prediction of the sediment transport at a point. Uncertainties here are carried over to any spatial model in which the sediment movement in a region is described in terms of the transport at a number of grid points. However, some consistency is gained by using the same assumptions everywhere and it may be possible to make useful distinctions between the sedimentary response in different areas. In cases where the underlying physical processes are sufficiently dominant, very simple models may be of interest. Pingree (1978) in showing that sand banks are associated with eddies in the residual tidal currents avoids the problem of a transport formula entirely. Perhaps more significantly, the model proposed for the formation of linear banks by the interaction of the tide with topography (Huthnance, 1982a and 1982b) uses a simple, Bagnold type, transport relation of the form

$$q_x \sim |u|^n (u + \lambda |u| dh/dx) \quad (6.7)$$

where down slope transport is enhanced by a small factor λ . In terms of (2.5),

$$\frac{\lambda \partial h}{\partial x} \sim \tan \beta / \tan \phi \quad (6.8)$$

This is generally a small quantity as $\tan \phi$, the friction angle, is normally assumed to be about 0.6, essentially the angle of repose of the material. Although the downslope term is normally small it plays a significant role because the tidal oscillations

from ebb to flood result in small net transport rates. This is illustrated in Fig. 6.4, where Lees shows estimates of maximum transport rates two orders of magnitude larger than the net transport averaged over a longer time scale.

A major shortcoming of all the existing sediment transport formulae, except Bagnold's, is the omission of any dependence on bottom slope. As these are empirical functions there is no logical way to include slope effects (Madsen and Grant, 1977). It is tempting to assume that bottom slope is not an essential parameter and, indeed, existing predictive models do not discuss it. However the models for tidal generation of sand waves (Cartwright, 1959; Richards, 1980) and sand banks (Huthnance, 1982) strongly suggest that an important balance is made possible by including an equilibrium slope which reduces the net transport to zero. A similar result, used to investigate beach equilibrium (Bowen, 1980) and complex bar structures on beaches (Holman and Bowen, 1982), suggests that relatively small slopes may play a significant role in balancing the tendency of surface waves to move material onshore.

A model of the Scotian Shelf on which banks, sand waves and beaches may be of central interest may have to include a bottom slope dependence.

b) PREDICTIVE MODELS

The ideal two-dimensional model would step forward in time by:

(i) computing typical orbital velocities for the particular timestep over the spatial grid. This would require a wave

forecasting model, a wave refraction/ diffraction model with a breaking criterion, and wave theories appropriate for a range of heights, periods and depths.

(ii) computing the current velocity at the sea bed over the grid. Requirements include wind and tidal models of the area, possibly three dimensional to include stratification, the input of statistical parameters (means and variances) to represent processes not specifically reproduced by these models and a model for wave driven currents.

(iii) combining wave, current and bottom roughness to predict parameters required for sediment transport formulae, that is models for computing the appropriate u_* , z_0 .

(iv) computing sediment transport vectors q over the grid with some control on the grain size distribution. This requires a sediment transport model incorporating threshold of motion, bedload, and suspended load, the influence of bottom slope, a grain size differentiation, and checks on the state of the sedimentary environment.

(v) computing erosion/deposition, $\nabla \cdot q$ (6.1), over the grid. This may not be necessary for every time step: the model would check availability of material for erosion, material added or removed at boundaries and possibly update the topography in light of erosion/deposition.

Fig. 6.7, taken from Sundermann and Klocker (1983), shows the mean sediment vector over a tidal cycle and the predicted erosion and accretion patterns for a grain size of 0.5 mm. The grid resolution is 400m. This is one of the more sophisticated

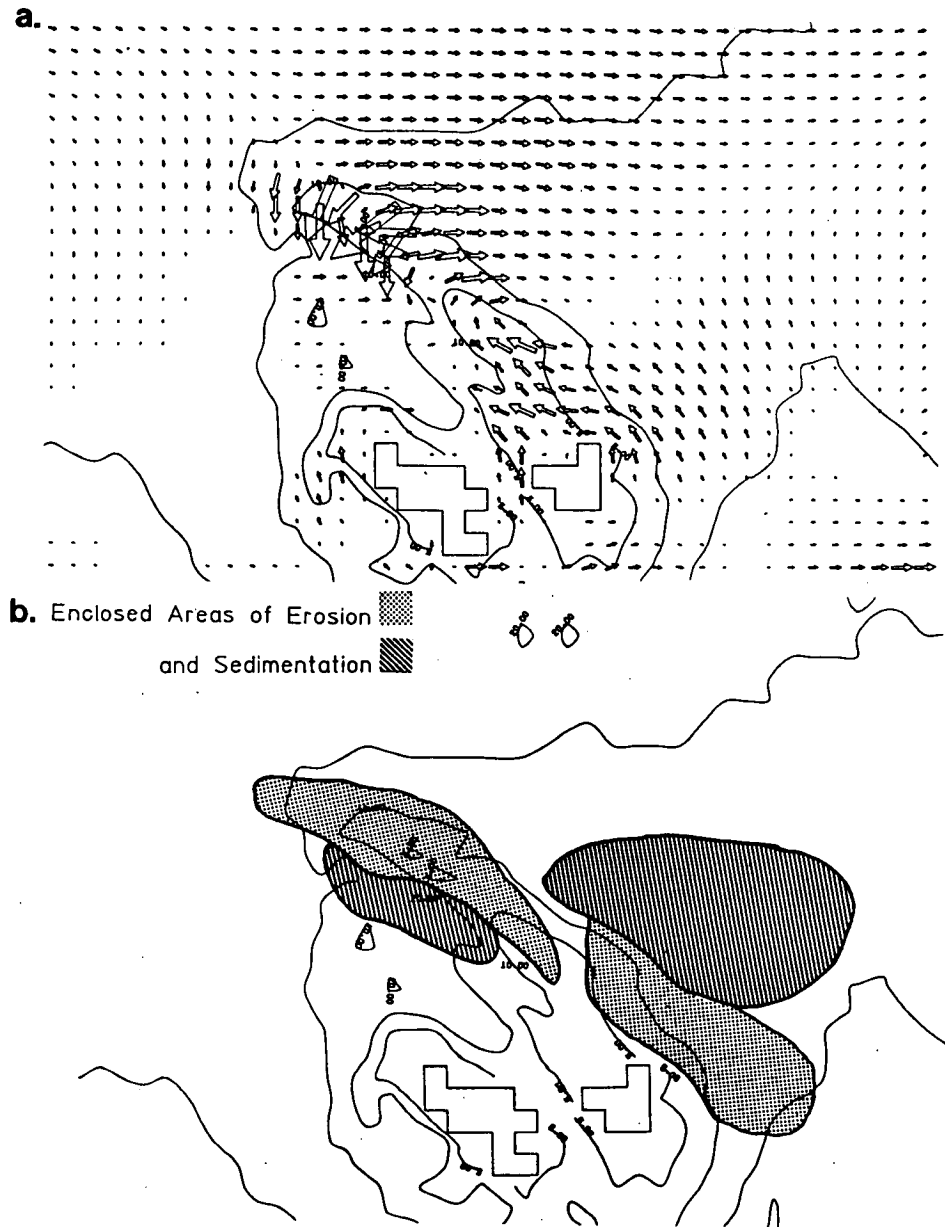

Fig. 6.7 (a) Transport vectors round Heligoland, grain diameter 0.5 mm. (b) Divergence of sediment transport expressed as areas of significant erosion or deposition (after Sundermann and Klocker, 1983).

models available and it is therefore interesting to see how it compares to the "ideal" model above:

- (i) there is no wave input,
- (ii) tidal currents are modelled in a two-dimensional numerical scheme into which some wind forcing could probably be included without serious difficulty,
- (iii) the shear velocity is expressed as the depth mean velocity divided by an empirical function involving the total water depth (a poor representation of the bottom boundary layer flow),
- (iv) a set of empirical equations for threshold, bed load and suspended load that are "based essentially on hydraulic model experiments, their extensibility for natural waters being not yet proved" (no effect of bottom slope is mentioned),
- (v) as the authors point out "the figure shows only possible sediment movements because the model does not check the actual covering of the bottom".

There is clearly some way to go to reach a practical prediction algorithm.

6.5 MODELS FOR SABLE ISLAND BANK

a) EXISTING MODELS

The models that have been most widely used to predict sediment transport on a shelf have not included wave effects. It is consequently not clear whether the scatter of predictions relative to the tracer data in Fig. 6.4 indicates a fundamental prediction problem. Simple models suggest that wave effects may be very significant (Fig. 6.5) and Thorn's data shows that, at

least in his particular environment, orbital velocities of 0.20 ms^{-1} increase the suspended transport rate by a factor of twenty.

As the Scotian Shelf is a classic case of a storm dominated environment in a geological sense, wave effects on the sea bed are of central interest. Engineering interest in extreme events further reinforces the need for a wave/current model for the shelf.

This requirement led to the development of a model to predict the stress and sediment transport at a point as a function of both waves and currents (Martec, 1982). The basic concept follows the work of Grant and Madsen (1979) for the determination of the stress due to the combination of waves and currents, previously discussed in Section 2.4. The sediment transport model used was the modified Einstein-Brown equation (2.10) which Madsen and Grant (1977) suggest using even in the presence of bedforms. However, provision was made in the model to use other transport formulae, the Engelund and Hansen (1967) total load equation and the Bagnold (1966) formulae for bedload and suspended load. All the equations were defined in relatively simple and unmodified forms, as opposed to the recalibrated and restructured versions of Gadd et al. (1978).

The input parameters required are:-

- the wave height, frequency and direction and the water depth (the parameters necessary to define the wave orbital velocity above the sea bed),
- the mean current (or tidal current) vector above the seabed,
- the grain size and bottom roughness.

In fact, some provision was included to estimate waves (or currents) using the local wind conditions. However, these are of very little value for a real shelf where conditions experienced at a point depend strongly on large scale patterns of forcing and topography.

The advantage of such a model is that it provides an opportunity to explore the implications of a rather complex formulation. Conditions for sediment movement in combinations of currents, wave conditions and water depths can be examined. The difficulty, inevitably, is the lack of data against which to critically test the results.

b) A TWO-DIMENSIONAL MODEL.

In a second report on transport modelling on the Scotian Shelf, Martec (1983) have proposed an approach close to that outlined in Section 6.4. The structure of the model is shown schematically in Fig. 6.8.

The hydrodynamic input proposed is much more complete than in any previous model. Looking at the various inputs in the same order as before, the model would:

- (i) hindcast the wave field, including refraction and breaking,
- (ii) predict tides and wind-driven circulation in a two-dimensional barotropic model,
- (iii) compute bottom stress as described in Martec (1982),
- (iv) compute transport as in Martec (1982),
- (v) determine accretion or erosion between each grid point over the period of interest.

A particularly innovative idea is the use of a sediment size

DETERMINE SPACIAL DISTRIBUTION OF ACCRETION OR EROSION

CALCULATE NET SEDIMENT TRANSPORT FOR SELECTED GRID POINTS

For columns from IF to IL by increment of II, and rows from JF to JL by increments of JI:

- Read grid point data
- Compute grain size distribution
- Initialize net transports to zero

CALCULATE THE NET TRANSPORT AT EACH TIME STEP DURING A STORM

For times from ITF to ITL by increments of ITI times three hours:

- Read storm conditions
- Compute tidal currents UT and VT.
- Compute wind-driven currents UWI and VWI
- Compute wave induced currents UWA and VWA
- Add all currents, $U = UT + UWI + UWA$ and $V = VT + VWI + VWA$
- Compute direction and magnitude of total current
- Compute wave height/period/direction distribution
- Initialize instantaneous transports to zero

CUMULATE INSTANTANEOUS TRANSPORT FOR EACH WAVE AND SEDIMENT COMPONENT

For wave directions D from 11.25° to 78.75° by increments of 22.5° :

Read the sediment transport look-up table corresponding to the current magnitude, and wave direction

For grain sizes S from SMIN and SMAX of NS, wave orbital velocities O from OMIN and OMAX by increments of NO, periods P from PMIN to PMAX by increments of NP, and

- Cumulate instantaneous transport from each component
- Compute direction and magnitude of instantaneous transport
- Convert transport to North and East components
- Write instantaneous transports rate
- Cumulate net transports
- Write net transports for this location
- Determine accretion or erosion between each grid point by taking the difference in net transport at adjacent locations

Fig. 6.8 Schematic outline of a model for computing sediment transport (after Martec, 1982).

distribution function defined by 10 size intervals of width 0.5ϕ in the range -0.75ϕ to 3.75ϕ , the observed range for Sable Island Bank. The total sediment transport rate is then defined by

$$q = \sum p_d \cdot q_d \quad (6.9)$$

where q_d is the transport of material of diameter d .

Some caution is needed in estimating q_d as most of the transport formulae are not readily generalized to multiple grain sizes. The problem is illustrated by Sundermann and Klocker (1983) who show diagrams of potential transport, such as Fig. 6.7, for a number of grain sizes. This does not necessarily imply that such transport rates can be attained for different sizes simultaneously. The physical limitations are most clearly seen in Bagnold's development based on energetic arguments which lead to (6.2). Bagnold suggests that there is a fixed maximum work rate and this must be shared by the various grain sizes. It is clear that, despite these difficulties, the development of an ability to handle a grain size distribution is an essential step which will eventually bring the model much closer to the geological view of sedimentary dynamics and consequently provide new possibilities for critical evaluation of the predictions. However, in the short term, the inclusion of multiple grain sizes will emphasize the uncertainty associated with the formulation of suitable transport relations for both bedload and suspended load.

In the present formulation the sediment distribution and sedimentary environment are assumed time invariant; this greatly reduces the advantages of the multiple grain size approach. For example, an interesting experiment would be to impose a spatially uniform grain size distribution and model its evolution in time.

The patterns of sediment distribution created would provide a further test of the validity of the representation of sediment transport.

An immediate need is therefore an algorithm for the conservation of sediment within each grain size category. This, in turn, leads to two further problems, an adequate definition of the initial sedimentary conditions (grain size distribution as a function of depth perhaps) and appropriate boundary conditions for the study region.

In many ways this prototype is a significant step towards the idealized model. However, the practical limitations are severe. The grid scale proposed is relatively coarse (7.4 km x 5.4 km) and would not even resolve the banks that Huthnance has been studying. The 3 hour time step suggested is rather long and will have to be shortened to adequately describe the tidal currents. However, the computing requirements for even this coarse resolution are formidable.

One of the central modelling problems is that these practical constraints on computer time seriously reduce the possibility of exploring the parametric dependence of the model. In practice these models involve three types of parametric input;

(i) the parameters associated with the basic physical equations. For example, tidal models must usually be calibrated by adjusting both the bottom friction coefficient and the tidal input at open boundaries. For the modelling of sediment transport there is the additional complication of the choice of possible equations, and various versions of these formulations,

each containing some further parameters requiring definition (drag coefficient, bottom roughness, critical stress for movement, etc.).

(ii) the parameters defining the forcing, initial conditions and boundary conditions for a model run. There is a natural tendency in discussing the modelling of an area such as the Scotian Shelf to think in terms of realistic inputs. However, this may not be the best approach to understanding the implications of the modelling procedure. The real structure is extremely complex and it may be difficult both conceptually and computationally, to perform a reasonable sensitivity analysis. Model runs with a simplified topography, hydrodynamic forcing or sediment distribution may provide much more insight into the model as a system.

The use of a multiple grain size distribution which is time invariant (Martec, 1982) indicates the danger of getting the worst of all possible worlds; a complex model that contains internal inconsistencies. However, resolving these inconsistencies by keeping track of all grain sizes again leads to very severe computational requirements.

(iii) the last set of parameters are those that define the modelling process itself, particularly the grid spacing and time steps. The obvious danger here is that the practicality of actually performing the computations may define a minimum grid spacing and, in doing so, redefine the actual problems to be addressed. Ideally, the maximum spacing should be limited by the assumption, implicit in the model, that each grid point is representative of the conditions within a region defined by the

grid scale. In practice, it seems likely that models sufficiently detailed to define the wave conditions will provide insight into the spatial variation of sediment transport, particularly the spatial structure in extreme conditions when the waves are large. A reasonable strategy may be to have tidal and wind-driven models of relatively coarse resolution, a wave refraction/diffraction model of necessarily finer scale and a sediment transport model of variable scale. It is perhaps worth noting that there are no dynamical constraints on the spacing of the sediment transport calculations themselves. However, rather severe difficulties emerge in following sediment fluxes through a region. The use of flux-corrected methods for such calculations is discussed by Amos and Greenberg (1983).

The disadvantage of proceeding with further development of a large-scale two-dimensional model is that relevant field data on sediment movement is not likely to be available. There is, therefore, the pragmatic problem of determining an optimal sediment transport formulation from among those shown in Fig. 6.4. The development of an optimal formula will almost certainly depend on comparison with field data from only one or two points in the region of interest. The next step, in fact, is likely to be a refinement of the single point models such as Martec (1982), as new data become available.

6.6 SUMMARY AND DISCUSSION OF FUTURE RESEARCH NEEDS

"In view of the variety of processes involved, the insufficient theories and the lack of adequately observed data,

modelling of sediment transport for natural areas is still in its infancy... A main problem of modelling is the lack of data from nature... a direct quantitative or even qualitative verification is impossible..." Sundermann and Klocker (1983).

Having said that, perhaps one has said it all! It is clear that extremely sophisticated models, computationally very demanding, can be developed whose relevance to the real world is virtually unknown.

The specific needs for improving sediment transport modelling have been considered in Section 2.5. Major advances have been made in recent years in field instrumentation, laboratory studies and theories relating to sediment transport prediction. However, this development has not allowed a clear discrimination between the various sediment transport formulae despite the obvious differences of their dependence on key parameters such as the velocity u (or friction velocity u_*). Clearly we need to know more about the physics of bottom boundary layers, particularly if we are primarily concerned with the extrapolation to predictions of extreme conditions. For this purpose, it is essential to know whether the transport varies as u_*^3 , as in Fig. 6.6, or as u_*^7 (Dyer, 1980).

In view of the uncertainty of these predictive formulae for sediment transport, it is easy to overlook the importance of the prediction of the hydrodynamic input. The dependence of the sediment transport on high powers of the velocity makes the calculation of transport very sensitive to errors in the definition of the hydrodynamic conditions. Fortunately the tidal currents are a significant component of the velocity field and

are reasonably predictable; unfortunately they are oscillatory and the net transport may be a small difference between two large transport rates (as e.g. in Fig. 6.4). For this reason, it is likely that the prediction of large, short-term transport rates provides a more rational first objective than the prediction of net rates over a long time scale. Unfortunately, tracer experiments tend to be representative of longer time averages. An obvious need is a tracer experiment which provides data from storm conditions with a strong preferred flow direction.

The input models for waves, tidal currents and wind-driven currents also need field calibration. This is relatively straightforward for the tides, and an interesting but tractable problem for the wind driven currents (such models have been under development for a considerable time, initially for storm surge forecasting), but a major problem for the wave predictions. Wave models, rather like sediment transport models, have reached a very sophisticated stage on a very narrow data base. Field programs to measure directional spectra are needed both to calibrate and validate the model results (Seaconsult, 1983). Our particular interest in extreme conditions also focusses attention on the current field driven by wave dissipation and breaking which may be significant over a large area around Sable Island itself and the shallower banks (Dolata and Rosenthal, 1984).

The overall needs for data suggest an extensive field program. However, most of the hydrodynamic problems are being tackled for reasons that are not primarily related to sediment transport. The central requirement at the present time is an

experimental program focussed on field measurement of sediment transport which includes measurements of all the primary inputs. This should include

(i) hydrodynamics - measurements of the wave orbital velocity, tidal and mean currents at some reference height above the bed. Measurements of the detailed velocity structure of the boundary layer, with estimates of skin friction and form drag (Chriss and Caldwell, 1982). Regional measurements of the velocity field to examine horizontal coherence.

(ii) sedimentary environment - bottom topography on all length scales, grain size distribution of suspended, surficial and subsurface sediment. Time-lapse photography of bottom boundary conditions. Assessment of biological activity.

(iii) sediment transport - tracer experiments (with careful consideration of the size and size distribution to be employed). Suspended sediment sampling, optical and acoustic monitoring of the suspension.

There are other requirements, direct measurement of bed load for example, for which methodology or instrumentation is not available. Indeed, some of the requirements included are difficult to achieve in practice, suspended sediment sampling in extreme conditions being one example. It is clear that such a program will be demanding of time and resources but it would provide an extremely important focus for the very wide-ranging interests in sediment transport and sedimentation. There are clearly models waiting to be tested; further model development, other than to improve the efficiency of the actual computation, is pointless without improvements in our basic understanding of

these processes or comprehensive data sets specifically designed to provide all necessary modelling inputs.

6.7 REFERENCES

- Ackers, P. and W.R. White, 1973. Sediment transport: new approach and analysis. Proc. Am. Soc. Civ. Engin., J. Hydraul. Div. HY 11, 2041-2060.
- Amos, C.L. and D.A. Greenberg, 1980. A simulation of suspended particular matter in the Minas Basin, Bay of Fundy - a region of potential tidal power. Proc. Canadian Coastal Conference 1980, Burlington, Ont. NRC. 2-20.
- Bagnold, R.A., 1963. Mechanics of marine sedimentation. in The Sea. M.N. Hill (ed.). Vol. 3 Wiley-Interscience. N.Y.
- Bagnold, R.A., 1966. An approach to the sediment transport problem from general physics. U.S. Geol. Survey Prof. Paper 422-I, 37 pp.
- Baird, W.F. and J.S. Readshaw, 1981. A comparison of hindcast and recorded wave data. Marine Environmental Data Services Contract Rep. Ser. 1, 23 pp.
- Bijker, E.W., 1967. Some considerations about scales for coastal models with moveable beds. Delft Hydraulics Lab. Rep. No. 50, 142 pp.
- Bowen, A.J., 1980. Simple models of nearshore sedimentation: beach profiles and longshore bars. in The Coastline of Canada. S.B. McCann (ed.). Geological Survey of Canada, Ottawa. 1-11.
- Cartwright, D.E., 1959. On submarine sand-waves and tidal lee waves. Proc. Roy Soc. London A 253, 218-241.
- Chriss, T.M. and D.R. Caldwell, 1982. Evidence for the influence of form drag on bottom boundary layer flow. J. Geophys. Res. 87, 4148-4154.
- Davies, A.M., 1983. Application of a three-dimensional shelf model to the calculation of North Sea Currents. in Sundermann, J. and W. Lenz (eds.). North Sea Dynamics, Springer-Verlag. 44-62.
- Dolata, L.F. and W. Rosenthal, 1984. Wave set-up and wave-induced currents in coastal zones. J. Geophys. Res. 89 1973-1982.
- Dyer, K.R., 1980. Velocity profiles over a rippled bed and the threshold of movement of sand. Estuarine and Coastal Mar. Sci. 10, 181-199.
- Einstein, H.A., 1950. The bedload function for sediment trans-

portation in open channel flows. Soil Conserv. Serv. U.S. Dept. Agric. Tech. Bull. 1026, 78 pp.

- Einstein, H.A., 1964. River sedimentation. in V. Te Chow (ed.). Handbook of Applied Hydrology. McGraw-Hill, N.Y. Section 17-II, . 35-67.
- Engelung, F. and E. Hansen, 1967. A monograph on sediment transport in alluvial streams. Technisk-Vorlag, Copenhagen, 62 pp.
- Gadd, P.E., J.W. Lavelle and D.J.P. Swift, 1978. Estimates of sand transport on the New York shelf using near-bottom current meter observations. J. Sed. Pet. 48, 239-252.
- Grant, W.D. and O.S. Madsen, 1979. Combined wave and current interaction with a rough bottom. J. Geophys. Res. 84, 1797-1808.
- Greenberg, D.A., 1983. Modelling the mean barotropic circulation in the Bay of Fundy and Gulf of Maine. J. Phys. Oceanogr. 13, 886-904.
- Heathershaw, A.D., 1981. Comparisons of measured and predicted sediment transport rates in tidal currents. Mar. Geol. 42, 75-104.
- Hill, P.R. and A.J. Bowen, 1983. Modern sediment dynamics at the shelf-slope boundary layer off Nova Scotia. in Stanley, D.J. and G.T. Moore (eds.) The Shelfbreak: Critical Interface on Continental Margins. SEPM Spec. Pub. 33, 265-278.
- Holman, R.A. and A.J. Bowen, 1982. Bars, bumps and holes: models for the generation of complex beach topography J. Geophys. Res. 87, 457-468.
- Huthnance, J.M., 1973. Tidal current assymetries over the Norfolk Sandbanks. Estuar. Coast. Mar. Science 1, 89-99.
- Huthnance, J.M., 1981. On mass transports generated by tides and long waves. J. Fluid Mech. 102, 367-387.
- Huthnance, J.M., 1982a. On one mechanism forming linear sand banks. Estuarine, Coastal and Shelf Science 14, 79-99.
- Huthnance, J.M., 1982b. On the formation of sand banks of finite extent. Estuarine, Coastal and Shelf Science 15 277-299.
- Jonsson, I.G. and J.D. Wang, 1980. Current-depth refraction of water waves. Ocean Engng. 7, 153-171.
- King, L.H., 1970. Surficial geology of the Halifax-Sable Island

- Map Area. Energy, Mines and Resources, Canada, Mar. Sci. Paper No. 1, 16 p.
- Leendertse, J.J., 1967. Aspects of a computational model for long period water wave propagation. RAND Corporation, Santa Monica, Memo RM-5294-PR. 165 pp.
- Lees, B.J., 1983. The relationship of sediment transport rates and paths to sandbanks in a tidally dominated area off the coast of East Anglica, U.K. *Sedimentology* 30, 461-483.
- Loder, J.W., 1980. Topographic rectification of tidal currents on the side of Georges Bank. *J. Phys. Oceanogr.* 10, 1399-1416.
- Madsen, O.S. and W.D. Grant, 1977. Quantitative description of sediment transport by waves. Proc. 15th Coastal Eng. Conf. Vol. 2. 1093-1112.
- Martec Limited, 1982. Sediment transport on a continental shelf. Atlantic Geoscience Center, Energy, Mines and Resources Canada. 60 pp.
- Martec Limited, 1983. A 2-D sediment transport model for continental shelves. Department of Supply and Services. Canada.
- Middleton, G.V., 1976. Hydraulic interpretation of sand size distributions. *J. Geology* 84, 405-426.
- Pingree, R.D., 1978. The formation of the Shambles and other banks by tidal stirring of the seas. *J. Marine Biol Assoc. U.K.* 58, 211-226.
- Resio, W.T., 1982. Assessment of wave hindcasting methodologies in the Scotian Shelf, Grand Banks and Labrador Sea Areas. Canadian Contractor Report of Hydrography and Ocean Sciences, No. 4
- Richards, K.J., 1980. The formation of ripples and dunes on an erodable bed. *J. Fluid Mech.* 99, 597-618.
- Seaconsult Marine Research Ltd., 1983. Shallow water wave calculations. Marine Environment Data Service. Fisheries and Oceans Canada. 75 p.
- Smith, J.D., 1977. Modelling of sediment transport on continental shelves. *in* The Sea. Vol. 6. Goldberg, McCabe, O'Brien and Steele (eds.) Wiley-Interscience. Chapter 13, 539-577.
- Sundermann, J. and R. Klocker, 1983. Sediment transport modelling with applications to the North Sea *in* Sundermann, J. and W. Lenz (eds.). North Sea Dynamics, Springer-Verlag,

453-471

- Tee, K.T., 1980. The structure of three-dimensional tide-induced currents. Part II. Residual currents. *J. Phys. Oceanogr.* 10, 2035-2057.
- Tee, K.T., 1982. The structure of three-dimensional tide-generated currents. Experimental verification of a theoretical model *Estuarine, Coastal and Shelf Science* 14, 27-48.
- Thorn, M.F.C., 1979. The effect of waves on the tidal transport of sand. Hydraulic Res. Station, Wallingord, U.K. Notes 21, 4-5.
- Tryggestad, S., K.A. Selanger, J.P. Mathisen and O. Johansen, 1983. Extreme bottom currents in the North Sea. *in* Sundermann J. and W. Lenz (eds.) *North Sea Dynamics*, Springer-Verlag. 148-158.
- Vincent, C.E., R.A. Young and D.J.P. Swift, 1982. On the relationship between bedload and suspended sand transport on the inner shelf, Long Island, New York, *J. Geophys. Res.* 87, 4163-4170.
- Vincent, C.E., R.A. Young and D.J.P. Swift, 1983. Sediment transport on the Long Island shoreface, North American Atlantic Shelf: role of waves and currents in shoreface maintenance. *Continental Shelf Res.* 2, 163-182.
- Yalin, M.S., 1963. An expression for bed load transportation. *J. Hydraulic Div. Proc. Am. Soc. Civ. Eng.* 89 (NY3) 221-250.
- Zimmerman, J.T.F., 1981. Dynamics, diffusion and geomorphological significance of tidal residual eddies. *Nature* 290, 549-555.

CHAPTER 7

RESEARCH PRIORITIES IN CANADIAN WATERS

by

DONALD O. HODGINS

President

Seaconsult Marine Research Ltd.

7.1 INTRODUCTION

Each of the previous five chapters has dealt with important topics in the field of sediment transport and soil stability under wave and current conditions. Physical processes, measurement techniques and predictive methods have been discussed in relation to current practice, and problematic areas limiting progress have been identified. The discussion has been of a fairly general nature and not focussed specifically on uniquely Canadian problems. The purpose of this chapter is to identify research priorities pertaining to Canadian offshore development within the context of the preceding review of sediment transport practice.

The key issues in sediment transport are discussed in the next section. These relate to problems ranging from pipeline and artificial island design to ice scour dating, glory hole sedimentation and beach stability in the Beaufort Sea. This is followed by a perspective on the present status of predictive methods (Section 7.3) which leads, in turn, to a set of recommended studies to address problems areas of immediate concern, and to more fundamental research directed at improving

our understanding of sediment transport processes.

7.2 KEY ISSUES IN SEDIMENT TRANSPORTATION

The central problems in sediment transportation for offshore hydrocarbon development are concerned with deformation of the seabed through erosion or sedimentation, or through soil failure, and the loss of soil strength by liquefaction. Consequently, sound engineering design requires reasonably accurate criteria on seabed levels and soil strength for the range of environmental conditions to be expected over the service life of the facility. The same is true, also, for extreme conditions in order to estimate the risk of damage and/or loss. In general these criteria are calculated using mathematical models, either statistical or deterministic in nature; thus, the key issues in sediment transportation have to do ultimately with predictive methods that relate transport rates, pore pressures and shear strengths to wave and current conditions in the water column.

a) OFFSHORE PIPELINES

The types of problems vary widely however, depending upon the engineering requirement, the soil properties, and the nature and severity of the local environment. The most pressing problems now deal with pipeline design and construction. A subsea pipeline has been proposed to bring Venture gas ashore from the vicinity of Sable Island. The sediment transport issue here concerns the mobility of sand wave bedforms and shore face-connected ridges with heights of 2 to 5 m and "wavelengths" of 800 to 1500 m and more (see e.g. Evans-Hamilton, 1976). These

are located in water depths of 20 to 50 m (Fig. 7.1) where surficial sediments are characterized for the most part by sand veneers overlying medium to coarse sand lag layers. Route selection and final pipeline design depend on knowing whether these sand waves and ridges are moribund or active, and hence to what maximum depth sand may be removed below some mean seabed level. This removal depth governs the burial depth of the pipeline and hence forms one of the most important criteria in the feasibility and cost analysis of alternative routes.

Pipelines are also being considered for transporting crude oil ashore from Beaufort Sea production sites in the Mackenzie River delta. In this area the critical zone occurs at the shoreline crossing in water depths less than 10 m. Presently, very little is known about seabed and beach stability in this area. The problem is complicated by: (i) the width of the zone, up to 30 to 50 km under wave conditions that are likely to be depth-limited by breaking over the majority of this width in storms; and (ii) the distribution of surficial sediments characterized by silts, silty-clays, fine sands, and some sand-gravel deposits (Fig. 7.2). During storms a strong coupling between surface waves and the water-sediment interface is expected, and it is not presently known if soil liquefaction takes place, and whether or not it plays a role in active transport of the sediments. Present understanding of the mechanics governing transport in this regime is, in fact, very speculative.

The engineering requirements centre on the depth of

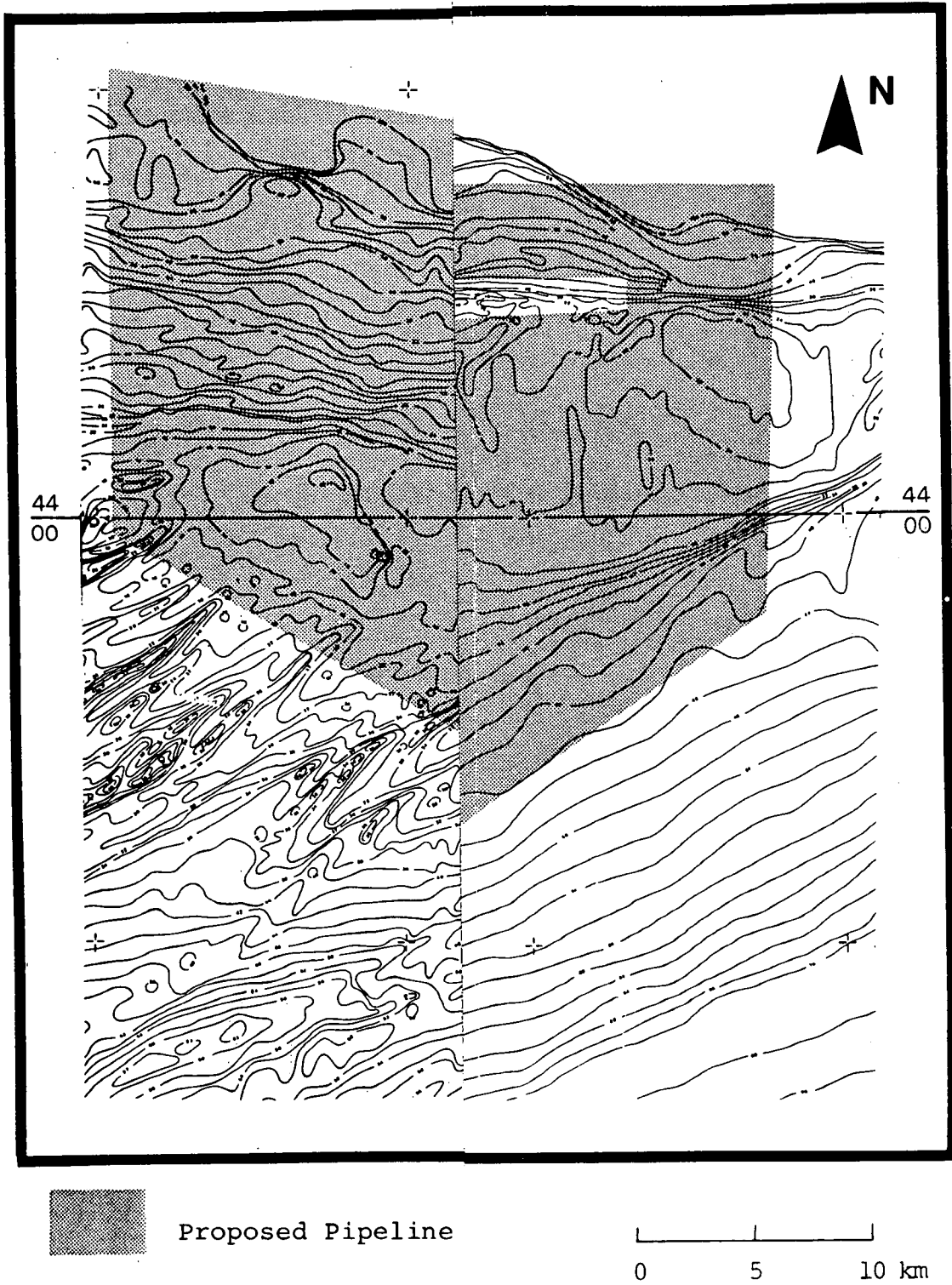

Fig. 7.1 I
F

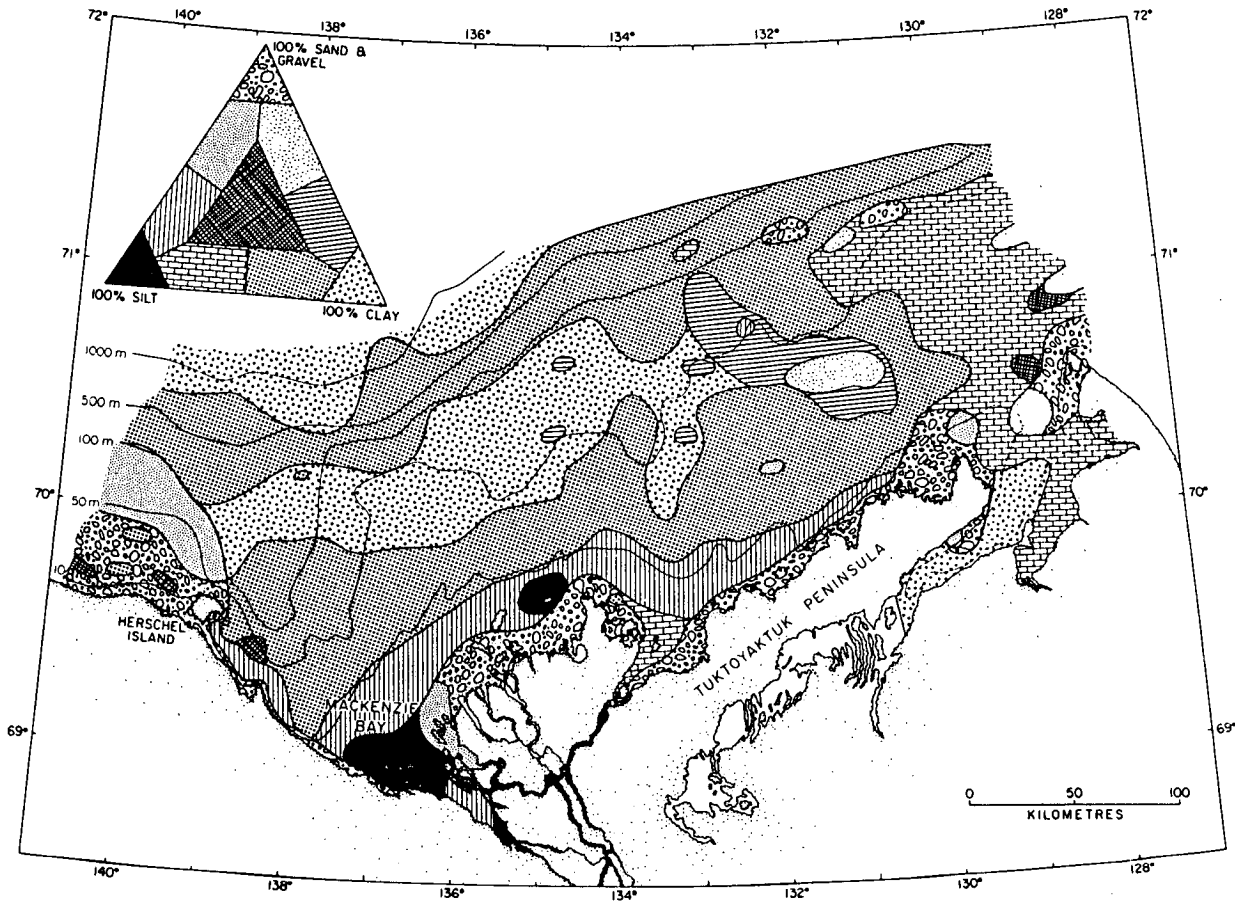

Fig. 7.2 The distribution of main sediment types on the Beaufort Shelf. The ternary textural diagram of main sediment types is after Shepard (1954). Source: Vilks et al., 1979.

disturbance, transporting or slumping potential of the sediments, the loss of soil strength under storm wave conditions, and the rates of beach accretion or erosion.

b) ARTIFICIAL ISLAND STABILITY

The stability of sand islands and berms constructed from dredged material in the Beaufort Sea remains a concern in two respects. Caisson retained islands for production facilities require protection from wave-current induced erosion over their expected service life. Protection may be designed either as permanent, or to be used in conjunction with remedial construction after especially severe events. In either case, analysis is required to predict the expected rates of erosion for a given design; the two crucial aspects are correctly modelling the wave hydrodynamics for diffraction, refraction, shoaling and reflection, and coupling these flows to a sediment transport procedure applied in three spatial dimensions.

The second situation is one of desired erosion to reduce abandoned islands to an acceptable draft for navigation. Once again the predictive problem is one of complex hydrodynamics and sand erosion over scales of 500 to 800 m.

c) SCOUR DATING

Finally, one must consider two aspects of sedimentation that affect offshore design decisions. The first concerns infilling rates for iceberg and ice ridge scours in the Beaufort Sea and on the Labrador Shelf and Grand Banks. The question here concerns dating the scours so that one may realistically calculate extreme depths to be expected over the service life of a facility. The

sediment transport problem is one of predicting the rate at which scour features are reworked by waves and currents, or covered by natural siltation alone or in conjunction with suspended sediment transport.

d) GLORY HOLE INFILLING

A very similar problem exists for infilling rates of glory holes and other depressions dredged below the mean seabed level for protecting subsea production facilities from ice impact. Depending on the size of the depression and the water depth, various simplifying assumptions about the boundary layer flows and the relative contribution of suspended and bedload transport may be made in formulating the solution. On the scale of a pipeline trench left to backfill by natural sedimentation, Fredsøe (1977), for example, has presented simple analytical solutions for the deposition of material based on suspended sediment concentration profiles in steady flows. More complicated numerical models will be required for larger excavations where the three-dimensional geometry is important in relation to the hydrodynamics, and where sediment transport may be related to unsteady flows (waves and currents) and to the evolving shape of the hole over time.

7.3 A PERSPECTIVE ON THE PRESENT SITUATION

The engineering problems identified above are quite different from one another. Solutions to them will require a great deal of site specific data, and also a number of different mathematical tools of varying complexity. However, before

providing recommendations for a series of separate studies, it would be useful to give a perspective on the nature of mathematical models for sediment transport as they exist now. This draws together a number of ideas from earlier chapters on predictive techniques, and leads to recommendations in two categories, one of studies addressing immediate concerns and one of projects that are more fundamental to the subject.

It is clear from the discussion in sections 2.4 on bottom boundary layers and 6.6 on models and the hydrodynamic data requirements for predicting sediment movement, that the present situation is rather unsatisfactory from the point of view of providing the engineering calculations required by industry. With respect to sediment erosion, available transport formulae are, by and large, based on dimensional considerations and empirically calibrated coefficients: they do not incorporate a proper physical understanding of the processes involved, for example, the inherently stochastic nature of the boundary layer flows and hence the bed stresses and resulting transport under various current and wave combinations.

Consequently they are difficult to generalize between flow regimes for the same sedimentary environment, and from one area to another. Moreover, different models give widely differing results; thus, the use of any one model will require careful field measurements for calibration and verification in a specific area. However, as discussed in Section 2.5 the limitations on measurements imposed by spatial and temporal averaging, and the inability to reliably measure some parameters such as bedload

transport, makes this an imperfect solution and much uncertainty will remain in predicted transport rates.

Thus one is led to conclude that presently available models for transport at a point are intrinsically unsuitable for predicting detailed patterns of erosion and accretion under a variety of hydrodynamic conditions because their formulation is too limited. The solution to this problem lies in obtaining a far better understanding of boundary layer processes, leading in turn to much clearer parameterization of the statistical variability of bottom stresses and their influence on sediments. The focus here is on processes at smaller scales than have customarily been examined in the past; this becomes necessary as one deals more with the turbulence than the highly averaged mean flow boundary layer properties.

Research of this kind is fundamental; it is presently constrained by a lack of suitable instrumentation and the difficulties and expense of mounting experiments in such shelf regimes as described above in the Beaufort Sea and on Sable Island Bank. Moreover, it is not clear that it would lead to dramatically improved prediction techniques in the short term. Rather one can envisage a series of experiments based on new developments in instrumentation, coupled with advances in theory that lead ultimately to models containing better parameter descriptions of the mechanics of transport related intimately to the sedimentary regime in the area of interest. In principle such models would then be better predictions of sediment movement given appropriate hydrodynamic inputs. However, instruments capable of rapid measurements of velocity and sediment

concentration profiles above the seabed and into the mobile layer, and of sediment movement in the mobile layer itself will be slow to perfect. As a result, advances in this area will likely require many years, and more than one experiment.

A number of recommendations for research in this direction are discussed below under the heading of fundamental research. This type of work must be considered in parallel with applied studies that seek to address more immediate industry needs largely through refinement of existing models and collection of site-specific data.

The reviews of predictive techniques for liquefaction given in Chapter 3 and for sediment transport in Chapter 6 have shown that, while recognizing the limitations outline above, practical methods providing some information valuable to design are in hand. The major limitations to using these models focus on sufficiently comprehensive field measurements to verify predictions. With sand transport models, such as that developed by the Atlantic Geoscience Centre (AGC) (Martec, 1982) total transport rates measured with simultaneous wave and current data over many tidal cycles and storms are required in order to verify predictions. Once calibrated such models would be useful for examining storm-induced sand movement, for example on Sable Island Bank. Similarly we have noted that although in situ verification data are lacking, analyses for transient pore water pressures are widely used in engineering practice.

Consequently, a number of recommendations dealing with the specific problems identified in section 7.2 are presented below,

under immediate research needs.

7.4 RESEARCH PRIORITIES

The previous chapters in this review and the above perspective have revealed a duality in research needs. One is concerned with developing a basic understanding of the nature of several important problems through data, and placing bounds on engineering criteria with available models. Existing technology can be used for this, and the emphasis will be on the application of data for calibrating models which will in turn be used to examine transport rates, erosion, accretion, or liquefaction parameters under a variety of wave and current conditions. The second need is for more basic research. Its objective is to improve the accuracy of the predictive models and hence the resulting parameters. It will require new technology particularly in instrumentation.

A number of studies in each area are outlined below. For convenience, applied studies are discussed in the regional-problem type categories used in Section 7.2. The priority for these studies depends upon the impetus for hydrocarbon development in each area and the timing for engineering criteria for the problem under study.

a) IMMEDIATE RESEARCH NEEDS

(i) Offshore Pipelines - Scotian Shelf

A - Measurement and Prediction of Sand Transport Rates on Sable Island Bank

The purpose of this study would be to obtain direct measurements of total sand transport at two or more sites along

proposed pipeline routes, and to use these data to calibrate existing prediction models for sand transport under winter storm conditions. The ultimate objective would then be to interpret measured and predicted transport rates with the regional surficial sediment data to give a preliminary assessment of seabed mobility and what changes may be expected from year to year in sand wave and ridge geometries. Since pipeline proposals involve routes on both the north and south sides of Sable Island (Fig. 7.1), one site should be located in each route where representative sedimentological data and storm conditions exist.

Based on Long's assessment of tracer techniques in Chapter 4 of this report, radio-isotope tagging methods are recommended to give a measure of the average total transport. Detection surveys should be made as closely as possible around major storm events over a one-winter program to determine the effect of storms on sand movement.

Site selection should be based on good knowledge of surficial sediments in each area. Some data on grain size distributions and the spatial distribution of sediment type and bedforms exist in the Geological Survey of Canada (Atlantic Geoscience Centre) and have been published in part by King (1970) and Amos and King (1984). These data should be assessed for their adequacy to specify the tracer grain size characteristics and representativeness of the sites in a regional context.

To aid in the geological interpretation of the tracer measurements, detailed bathymetry and sidescan sonar data should be collected at the sites. Repeated surveys should be considered. These basic data should be supplemented by still

photography, time-lapse photography and grab samples for grain size distributions. Coring in the tracer cloud should be carried out near the end of the survey to determine the depth to which radioactive grains have been buried. This dimension is an important parameter in the calculation of transport rates from the tracer cloud data.

In order to calibrate and apply existing and new predictive models such as those described in Chapter 6 (e.g. the AGC sand transport model) measurements of near-bed mean currents and wave conditions will be required for the duration of the tracer experiment. In addition boundary layer velocity profile measurements, essentially repeating the approach described by Grant et al. (1983) in the CODE experiment should be made under energetic conditions. These measurements would allow estimates of the roughness length z_0 for combined wave/current conditions. This is an essential parameter in the Grant-Madsen stress formulation and enters into the AGC sand transport model. Suspended sediment data, preferably profiles, and time lapse photography, should be made synchronously with the velocity measurements. These data would provide estimates of the suspended sediment flux, and bedforms in relation to wave and current conditions.

Existing shelf models with as full a formulation for bed stresses under combined wave/current conditions as the AGC model (Martec, 1982), combined perhaps with simpler formulations (e.g. Ackers and White, 1973), should be applied with these data. The initial objective would be to see if the models can reproduce the

tracer results, and if so what are the transport implications under more severe storm conditions.

This study will provide essential data on sand transport rates on the proposed pipeline route, and will indicate whether or not available total load prediction models are capable of reproducing observed trends. However, as explained in Sections 6.4 and 6.5 both theoretical and practical limitations on existing two-dimensional models based on these formulae preclude their use for calculating changes in sand wave geometry over scales of 500 to 1000 m with the required precision. Consequently, it is unlikely that sand transport models will provide reliable information on maximum depths below mean seabed level, or the existing seabed position, that would result from sand wave migration.

Geologically the sand waves referred to by Evans-Hamilton (1977) on the western side of Sable Island are shore face-connected ridges whose genesis and age are unknown (C. Amos, Atlantic Geoscience Centre, pers. comm. 1986). Very little information is available on their motion, although net migration rates are suspected to be less than 50 m per year, and possibly much less. Limited vibracoring on some ridges to the west, south and north of Sable Island to give data on soil composition with depth has been done by E. Hoogendoorn of Queens University in conjunction with the Atlantic Geoscience Centre. Combined with new shallow seismic data and grab samples it now appears that ridges are comprised of sands with varying grain sizes and compactness down to about the depth of the troughs between ridges.

Troughs appear to be found in a transition zone to a shell and gravel lag layer that possibly limits the depth of erosion. Surficial sediments over the ridges are fine to medium sands with average grain sizes from 0.1 mm near the bottom upstream face, and becoming coarser to about 0.3 to 0.4 mm on the downstream or slip face. Movement is suspected to be from west to east. The edge of this slip face is usually well discriminated from material in the next trough by a strong acoustic signal. This edge is thus amenable to sidescan sonar mapping.

Available data are presently being interpreted and described by E. Hoogendorn at Queen's University, but are too spatially limited to generalize conditions over much of the proposed pipeline routes, and will not in themselves, provide estimates of migration rates. There remain, then, several problems to be addressed. These include making measurements of sand ridge translation, determining the relationship of trough depths to changes in material properties -- specifically seeking to show that coarser material in lag layers does act as a natural limit to trough depth between ridges and to what geographical extent this may be true -- and determining the mechanics governing ridge migration. These requirements form the basis of a sand wave migration study.

B - Sand Ridge Migration Study on Sable Island Bank

The objectives of this study are, for selected critical sites for pipeline routing, to:

- measure the translation rate of sand ridges,
- establish sand ridge material composition and map the extent the coarse lag layers underlie pronounced ridges, and

- establish the sediment transport mechanics governing the translation process.

The third objective is likely to be very difficult to achieve; therefore, the first and second objectives have a somewhat higher priority. It must be recognized, however, that until the mechanics governing transport is established, predicting the motion of ridges and maximum removal of material in the troughs will not be possible.

Since the translation rates are expected to be low the study may well require two or more winter seasons to establish meaningful values. This provides an opportunity for some complete mappings before instruments are placed to measure currents and sediment motion, thus allowing careful site selection in relation to bedforms, soil types or other observed features.

The recommended procedure for mapping migration rates is repeated sidescan sonar survey (500 KHz) using predeployed reference markers that given an unambiguous acoustic signal with respect to the sharp edge of the slip face. A survey pattern along an axis perpendicular to the predominant ridge orientation would allow deployment of several marker sets between successive ridges. Migration data collected this way would reveal any differential motion between ridges that may be taking place. Two or three surveys over each winter season, related to severe stormy periods should be considered. Accurately navigated mosaics should be prepared for each survey.

Coring to give a cross-section of material properties through two or three dominant ridges should be carried out,

together with grab sampling to determine the grain size distributions and composition of surficial sediments. Grab samples should be collected in summer and winter to establish any differences.

Subbottom stratigraphy should be established with a shallow seismic survey. The new Nova Scotia Research Foundation sparker system is potentially useful for discriminating the lag layer underlying the ridges (C. Amos, Atlantic Geoscience Centre, pers. comm., 1986) and should be considered for this purpose. The objective is to relate the spatial extent and structure of coarse lag layers to trough depths.

The working hypothesis concerning the sediment motions is one where currents move sediment up the front face, and over the crest to be deposited on the rear slip face of each ridge. This process is expected to be sporadic, linked most probably to storms. It is not known whether sands move normal to the crest orientation, or follow some diagonal path, although the latter seems more generally correct (see e.g. Engelund, 1981). The hydrodynamics of flow over the ridges has yet to be established, as well as the flows associated with troughs. It is not known, for example, whether preferred flow orientations are found in the troughs, giving rise to down-slope sediment movements there independent of sand transport on the ridge itself.

With so many unknowns the deployment of current meters and transmissometers for suspended sediment concentration is best considered in two stages. Following the first sidescan survey prospective deployment sites locating instruments in one trough

and on an adjacent crest should be isolated. Instruments to be included are: 1) burst-sampling current meters, and 2) transmissometers, both controlled for conditional sampling over storm periods. The objective would be to infer sediment transport from observed current orientations, magnitudes and suspended sand concentrations.

Following interpretation of these measurements with the features shown in the sidescan mosaics, a second deployment of current meters and suspended sediment monitoring devices should be made. Several devices "profiling" a ridge-trough system should be considered. The objective of these measurements would be the calibration of a predictive model for erosion. If scour in the troughs is discovered this may be the aspect to concentrate on. Otherwise one would want to correlate the slip face migration rate with the forcing oceanography through use of a model.

(ii) Offshore Pipelines - Beaufort Sea.

There are two areas of particular importance for shoreline crossings for pipelines. These are at North Head and at Toker Point (Fig. 7.3). Studies to date, on sediment transport (e.g. Pinchin et al., 1985), sponsored under the Northern Oil and Gas Activities Program (NOGAP), have been of a general nature, examining problems from an idealized perspective. The need now is for more detailed, and comprehensive site-specific information.

Within the area shown in Fig. 7.3 virtually no data exist on sediment properties and wave-current conditions inside the 10 m depth contour. Thus engineering analyses for beach stability,

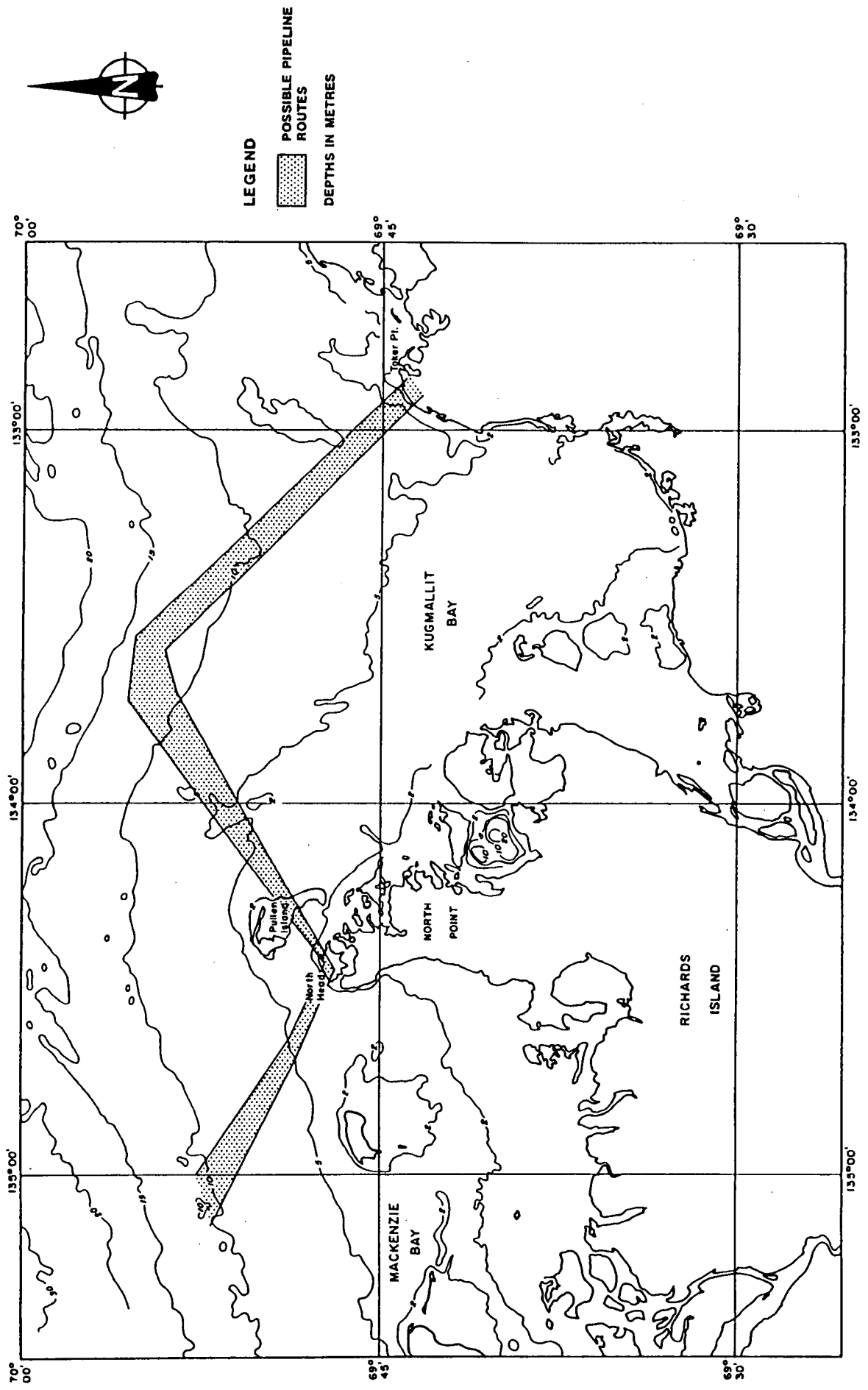

Fig. 7.3 Possible pipeline routes and shore crossing areas in the Beaufort Sea.

sediment transport in the breaking wave zone, and changes in soil strength under storm conditions are greatly constrained by a lack of data upon which to base the calculations, and data to confirm these quantitative estimates.

For this reason a number of site-specific studies are recommended. While North Head and Toker Point are identified as possible sites for pipeline crossings, many of the same problems apply to Tuktoyaktuk Harbour and King Point as supply bases for offshore development.

A- Sediment Behaviour in Storms - Problem Definition Study

Because the surficial sediments are fine with a high silt fraction (Vilks et al., 1979), soil liquefaction under storm waves may be expected. If it does occur it has many engineering ramifications including potential slumping or high transport rates with a deep disturbance depth, pipeline stability and backfill considerations, and pipeline trench stability during construction. Therefore a study is required to define and quantify to what extent liquefaction takes place, to what depth in the soil, and with what consequences for sediment transport.

The major component of this study would be in situ pore pressure measurements, from the seabed down as deep as possible into the soft, fine sediment layer (3 or 4 depths). Two or three monitoring sites should be occupied in a line out from shore so that different wave conditions (e.g. steepness due to shoaling and breaking) can be monitored.

In addition, the sites should be instrumented to measure wave-induced water velocities and suspended sediment

concentration near the seabed. If the seabed pressure sensor is combined with a two-axis current meter these data can provide estimates of the directional wave spectrum. This information would prove extremely valuable for verifying predictive models for waves and currents in the shallow water zone.

Basic water and soil property data are also required at the sites. These include water temperature and salinity to give density over depth, sediment type, grain size distribution, and specific gravity at various depths, into the surficial soil mass.

In addition, effective stress models such as STAB-MAX (Section 3.7) can be used to predict seafloor stability. Data required for interpretations based on modelling include:

- in situ permeabilities
- sediment porosity
- gas content.

The suspended sediment and current meter data would provide information on expected rates of transport for material in suspension. These may be related to concurrent pressure data to see if obvious links to liquefaction are evident. These processes can then be tied back to the variations observed in storm wave heights and currents.

This study would provide a first look at the problem and establish some of the basic connections between forcing conditions and the seabed response. Successful application of transient pore pressure models would, of course, provide a basis for analysis of extreme conditions directly related to pipeline and trench stability.

B- Baseline Data for Beach Stability Analysis - North Head and Toker Point

The purpose of this study would be to compile baseline data that would be used for an engineering analysis of long term beach stability in the shore zones of expected pipeline crossing. Ultimately some form of beach plan form and/or profile modelling would be carried out as part of this long-term assessment. The data to be collected in this study address three aspects of the problem:

- present shape and composition of the beaches,
- hydrodynamic factors affecting erosion,
- data on beach changes useful for calibrating and verifying model predictions.

This study is envisaged as a multi-year effort based in a large part on repeated mapping of beach geometry, following an initial, intense survey to determine beach structure and the factors controlling sediment supply.

The initial survey would involve establishing bench marks as controls on the first year levelling and for subsequent years. The beaches would be surveyed to give a complete topographic description (contour maps and selected profiles) from above the zone of ice push to a point offshore of the active littoral zone. It is anticipated that this latter point may be difficult to recognize in advance, and it may be extended or reduced in later surveys. The detailed topographies should be complemented with a detailed analysis of sediment properties on the seabed (type, grain size distributions), and with depth below the seabed by coring on selected transects. The coring program should be done

in conjunction with shallow seismic leading to a description the seabed stratigraphy. This mapping would be completed by a descriptive features analysis including rock outcroppings, erodable cliffs, etc. that govern longshore sediment movement.

The beaches should then be resurveyed a number of times each summer following storms. The objective would be to provide a qualitative picture of storm-induced erosion that can be monitored in situ in considerable detail, and quantitative data for evaluating numerical models. During the course of the survey work, the following physical measurements should be made:

- wave induced (2-5 Hz) and mean near-bed currents, at two locations, one inside and one outside of the breaking wave zone,
- suspended sediment concentration, in conjunction with the currents,
- wave elevation (2 Hz) just outside the breaker zone and breaking wave type (visual classification and photographic records),
- tide and storm surge water level variations
- local overwater winds.

Both of the above studies lead to the use of numerical models to extrapolate sediment behaviour to conditions other than those at the time of measurement. Shallow water wave conditions are fundamental input data to any of these models. Because of the extensive width of the transition zone between deep water and the near-shore surf region and the soft bottom sediments contained there, the wave transformation processes in the Beaufort Sea are expected to be very complicated. Specifically there may exist a high rate of momentum and energy transfer to the sediments, that changes abruptly if liquefaction occurs, and

repeated breaking as waves propagate shoreward. Studies in other areas (e.g. Dally et al., 1984) have shown that in regions of repeated breaking, depth-limited maximum conditions are changed from conventional criteria. Maximum wave heights, for example, are constrained to some 40 to 50% of the depth, down from 78% under the usual depth-limited formula. Thus parameterizing wave inputs spatially across the transition zone will require careful calibration of wave models. In each study above wave data at various points offshore are recommended. Ideally one would like to obtain simultaneous records from "deep water", e.g. 25 m, and at depths ranging from 15 down to 5 m along the principal rays followed by storm waves at each beach site. Data should be collected that provide estimates of directional spectra; however, one-dimensional (non-directional) spectra would suffice to examine saturation effects and the influence of wave-sediment interaction in preferentially damping certain frequencies.

Such results would be suitable for verifying spectral wave models that account for refraction and dissipation through bottom friction. Since spectral models are expected to provide the best representation of irregular wave conditions, they should receive more attention than regular wave height-period models.

Both studies recommended above require reasonably extensive logistics support and some degree of shared facilities is expected. Additional wave measurement sites should be considered in planning either or both of these studies, with a view to establishing the validity of shallow water wave calculations.

iii) Artificial Island Stability

Construction techniques for artificial islands in the Beaufort Sea have evolved over the past 15 years, with designs that range from sacrificial islands with low beach slopes in shallow water, comprised mainly of sands, to coarser material steep-slope islands in deeper water (Moir, 1986). Stability of these designs has been investigated mainly with scale model tests, or simple one-dimensional "beach-profile" mathematical models. As more permanent islands are being considered for production facilities there is a need to improve analysis procedures for erosion in storms. A study to develop mathematical models for this purpose is recommended. These models are seen as complementary to scale model tests in basins.

A - Model Study of Island Erosion in the Beaufort Sea

The objective of this study would be to develop and test a mathematical model to predict the three-dimensional topography of an artificial island of arbitrary initial shape under irregular incident wave boundary conditions. The model must compute the surface wave pattern around the island considering reflection, refraction, diffraction and shoaling-breaking processes. The wave module would provide the bed velocities and stresses required by the sediment calculation.

A sediment balance model would be coupled to the hydrodynamic solution at an appropriate time step. The sediment calculation would have two parts, first, prediction of the magnitude and direction of suspended and bedload transports, due to the imposed stresses, and second, a conservation of sediment mass to give the changes in topography produced by erosion and accretion.

A specific sediment predictor is not recommended; rather part of the study should be devoted to selecting the most appropriate formula or formulas based on how the wave-induced stresses are handled (i.e. instantaneous or averaged over the wave period). The formulation should also address the importance of bed slope to the solution.

Model predictions should be verified with measured island changes under wave attack, either at prototype or model scales or both.

iv) Scour Infilling

Over the past two years studies have been carried out by the Geological Survey of Canada (Atlantic Geoscience Centre), by C-CORE, and by the ESRF to examine this problem. Most of the attention has focussed on the Hibernia region of the northeast Grand Banks, although the DIGS (Dynamics of Iceberg Grounding Study) 1985 program was conducted on the Labrador Shelf.

The character of scours is governed by the composition of the surficial sediments in which they are located. Furrows in cohesive soils are expected to remain undisturbed the longest, compared with scours in fine silty-sand soils which would be reworked and filled in fastest. Manned submersible cruises on Grand Bank have shown, for example, periods of high near-bottom turbidity in these latter soil regimes. Thus the expected mechanisms for sedimentation in scours is principally one of sediment resuspension during storms and transport into scours by mean currents.

This hypothesis is presently unconfirmed. Staking studies

are in progress now, with long-term monitoring of changes in scour bottom position by visual inspection of the stakes. Glass bead tagging of sediments, surveyed by grab sampling and subsequent neutroactivation (chapter 4), has been attempted in order to give the direction of sediment motion (M. Lewis, Atlantic Geoscience Centre, pers. comm., 1986). Some preliminary transport calculations have also been made with Einstein (1950) and Bijker et al. (1976) models using measured currents for input (V. Barrie, C-CORE, pers. comm., 1986). Transport rates of the order of $1 \text{ m}^3/\text{m}/\text{year}$ were found but these are suspected of being very low.

Thus the major requirement at this time is for a study to confirm the hypothesis for infilling, and to calibrate a useful predictive model that can be used to estimate the rate that scours are obliterated. Such information would be directly useful for dating scour observations in the various databases. The emphasis presently rests on the Hibernia-Terra Nova region of the Grand Banks.

A - Scour Infilling Predictions for the Grand Banks

The objective of this study would be to measure suspended sediment transport rates adjacent to a major scour feature in an area of proposed hydrocarbon development, and to develop a predictive model based on these data for suspended sediment transport and sedimentation in the scour. Coordination of this study with the ongoing staking studies is recommended where possible.

A program of detailed boundary layer measurements, comprised of:

- vertical profile of wave-induced (2-5 Hz) and mean flow velocity (20, 50, 100 and 250 cm above the seabed)
- suspended sediment measurements (2-5 Hz) at 20 and 100 cm above the seabed.
- high-resolution video recording of sediment motion, is recommended. Deployments should be planned around storm periods, or conditional sampling instruments could be used to capture high energy events.

Theoretical approaches to modelling suspended sediment fluxes are discussed in Section 2.3 b). Procedures like those described by Lesht et al. (1980) or Vincent et al. (1982) are appropriate, although the difficulty of interpreting results from only one or two transmissometer levels must be considered. Acoustic profiling of suspended sediment is the preferred technique because of the greater detail provided on vertical distributions. The need for this type of instrument is discussed below.

A second calculation would be required to predict the rate of sedimentation in the scour itself. This could be done solving for the differential transport between the scour trough and the adjacent seabed using modified boundary layer velocity profiles. Some correlation of predictions with stake survey data would be required to establish confidence levels on the predicted changes in seabed level in the scour.

The above approach assumes that virtually all of the sedimentation results from suspended sediment transport over the scour. It is applicable to deep shelf regions where combined wave current conditions do not give rise to any significant

bedload transport. In shallower coastal zones the zero-bedload assumption will likely break down and a total load model would be required instead of the strictly suspended load approach. Also, in the case of bedload transport, a monitoring technique for total load -- radio-isotope tracing or staked excavations, for example -- should be added to the field programs.

B - Ice Scour Properties in the Beaufort Sea

The maximum soil depth to which ice penetrates in the nearshore zone of beaches such as those at North Head and Toker Point in the Beaufort Sea is one of the major design considerations for pipeline shore crossings. The environment is very different than on the Grand Banks: principally water depths are less than 10 m versus 80 to 100 m, and sediment transport is potentially much more active in covering scour signatures. It may be hypothesized that scours produced over one winter, are obliterated within one or a few open water seasons by a few storms.

Thus a database on scour properties in the nearshore zone can be realistically built up only by repeated sidescan/sounder surveys in periods following ice retreat and around major storms. The problem then is not one of dating scours as on the Grand Banks but of collecting reliable statistics on pristine signatures before they are badly reworked.

A study of scour properties in specific nearshore areas by repeated mapping, and by discovering and staking major features for later surveying may accomplish two aims. First, the depths of disturbance observed immediately after ice retreat can be

compiled and related to soil properties and stratigraphy. Second, the rates of infilling caused by storms can be roughly quantified.

(v) Glory Hole Infilling

This problem is very similar to that described previously for scours, except that the size of the excavation would be much larger, up to 500 to 800 m. The starting point would be the same as that above: the collection of site-specific sediment and hydrodynamic data in a location of planned production. The purpose would be to calibrate a numerical model for suspended sedimentation over a region of seabed surrounding the glory hole and into the hole itself. The response of sediments inside the hole would depend on its geometry and the material properties of the side walls and bottom. Consequently these parameters must be known. Careful consideration of wave-induced currents in the hole would be required since the size of the excavation is about the length of long ocean surface waves.

A separate study is not identified here since in many respects it parallels the scour infilling study.

b) **FUNDAMENTAL STUDIES**

There are three important areas of research and development that are required to improve sediment transport prediction. The first deals with acoustic monitoring devices. This type of instrumentation would be of major benefit to many of the studies recommended above if it were available. Thus, this line of research is viewed as extremely important. The second deals with improvements in boundary layer theory: this is a complex area

linking theory and refined measurements at the seabed, but is regarded as fundamental to incorporating better physics into predictive models. The third suggests an approach to capitalizing on model calibrations resulting from the study to measure sand transport on Sable Island Bank.

A - Acoustic Suspended and Bedload Transport Instrumentation

Instrumental techniques for monitoring suspended load transport and bedload transport rates are required. The reviews presented in Chapter 5 of this report, and by Huntley (1982), indicate that acoustic profiling devices, most likely separate systems for suspended and bedload phenomena, are the most promising. These devices would measure sediment concentration and horizontal velocity in the water column, and the thickness and translation rate of sediment particles mobile in the bed. Several prototype devices have been developed in the U.S.A. and England; these have been reviewed by Hay and Heffler (1983), who then also give detailed specifications for an acoustic profiler for suspended sediment motion. These specifications formed the basis of follow-on development work by the National Research Council (Ottawa) to build a Canadian prototype instrument.

A bedload device was being developed by Lowe and co-workers at the Scripps Institution of Oceanography (Hay and Heffler, 1983). In 1983 preliminary tests for detection of the mobile layer thickness were promising but further development was required on a second sensor for velocity.

It is clear that an understanding of transport processes in the littoral zone and on continental shelves for the problems

identified in the previous section demands accurate measurements of these phenomena. So also does any realistic hope of calibrating detailed predictive models for sand transport. Thus a study or program of development for acoustic instruments is a highly priority in this field.

For suspended sediment most of the theoretical problems have been solved and development is largely a matter of detailed engineering. Decisions on signal averaging and on-board processing to achieve acceptable data storage remain to be addressed (A. Hay, Memorial University, pers. comm., 1986) but these are aspects that can be resolved. The next step is construction or continued development of a working prototype (specifications are given in Hay and Heffler, 1983) followed by field testing. As recommended by Huntley in Chapter 5, intercomparison with optical sensors, seeking to distinguish grain size from concentration effects, should also be considered in such tests.

Insofar as bedload sensing is concerned, progress achieved by Scripps should be monitored and as appropriate, development of a number of working instruments should be pursued.

B - Stress Parameterization in the Boundary Layer

In chapter 2 of this report Huntley has emphasized the importance of two aspects of stress parameterization in the boundary layer: stress intermittency related to bursting phenomena and the form-drag problem introduced by bed ripples. Uncertainties in previous measurements and their interpretation in dealing with these factors can account for large differences

in predicted stress and hence in transport rates reported by various authors.

Studies are therefore required to determine the statistical variability of bottom stresses and the correspondence between stress and sediment motion under combined wave-current conditions. The statistical descriptions that result must be related to mean flow parameters, and to threshold conditions at which particles are suspended, or moved in the bed. Clarke (Hay and Heffler, 1983) has indicated, for example, how sediment suspension may be linked through turbulence bursting mechanisms in the shear layer to the long wave "beat" frequency of surface waves in shallow water. These observations were made with an acoustic backscatter sediment concentration profiler and simultaneous wave data.

Phenomenological measurements are required under irregular wave conditions with varying intensities of mean current. Observations of near bed velocities (5 Hz), suspended and bedload transport, bedform evolution and wave properties are essential elements. These should be combined with video or cinefilm recordings from which correlations of sediment suspension and the influence of ripples with high frequency time series measurements can be made.

The separation of form drag from skin friction in the presence of ripples must also be addressed. Instrumentation for measuring velocities at the water-sediment interface along the lines of Chriss and Caldwell (1982) or Gust and Weatherly (1985) are promising in this respect.

Experiments of this kind could be made in the laboratory or in the field. For reasons of experimental control, data acquisition and cost, one-to-one scale laboratory tests might be preferable initially, however, removal of unwanted transient waves and the simulation of realistic natural conditions would have to be carefully considered. Field measurements are clearly more difficult but avoid the problems of modelling wave-current conditions in flumes.

The objective of these studies would be parameter descriptions of turbulent bed stresses, and the resulting sediment transport in relation to observable wave and current properties. In many respects these experiments will depend on success in perfecting acoustic monitoring techniques, described above, and other instrumentation for very near-bed skin friction measurements.

C - Continued Development of Predictive Models for Sediment Transport

One of the principal objectives of the study to measure sand transport rates on the Scotian Shelf is to provide calibration information for existing transport models. The data collected there should establish the validity of one or more point predictors. As discussed in Chapter 5, however, one limitation to using these models more generally around Sable Island Bank is the lack of reliable hydrodynamic input. Also, as discussed with respect to the two-dimensional AGC model (Martec, 1983) space and time scales are presently too coarse for engineering use.

Two ideas are worth pursuing to take maximum advantage of a "calibrated" point-predictor for estimating sand movement under

storms. The first concerns the concept of nesting grids of different sizes, from large scale coarse grids for tidal and wind-driven currents, to finer grids for wave spectra, to high-resolution local area sediment grids concentrating on regions specific to the pipeline routes. The second deals with multiple grain sizes, and size distributions, over the sediment grid. The objective of this study would be to develop a sediment transport hindcast model using verified hydrodynamic inputs for realistic sediment conditions.

Several barotropic current models exist, within both the Department of Fisheries and Oceans and private industry, that are capable of modelling tidal flows on the Scotian Shelf and onto Sable Island Bank. With some limitations, that become less important as one moves into shallower water near Sable Island, these models can also be used for wind-induced currents. The study should apply one of these models for tides and wind to establish calibration factors and expected accuracy using the reasonably large set of industry collected current meter data. The focus would be on Sable Island Bank in water depths between 15 and 50 m.

Shallow water spectral wave modelling on Sable Island Bank has been carried out by Mobil Oil Canada Ltd. in conjunction with the Venture Development Project, and by Seaconsult Marine Research Ltd. in ESRF study no. 313-07-08, to be reported in mid-1986. Both studies are similar in that an advanced spectral wave model (Resio, 1982) has been applied on triple nested grids giving bathymetric resolution down to scales of 2 to 5 km. In

the latter study model predictions will be compared with directional wave measurements in 20 and 12 m of water south of Sable Island to establish seabed dissipation factors and the accuracy to be expected from such models in shallow water.

Thus the hydrodynamic modelling techniques required for providing input to the sediment calculation largely exist. It remains to calibrate the models and synthesize outputs for currents and waves over a limited area, suitably interpolated onto the sediment model grid. It is noted that these models are now routinely run on high-end micro-computers in industry; thus, the cost of this type of application is not as big a factor as it was a few years ago.

The sediment calculation should be confined to an area of the order of a few kilometres on a side with grid scales of 50 to 100 m to resolve features of interest to pipeline design. The concept of a sediment size distribution, described by Bowen in Chapter 6, should be included in the transport calculation. This would open the way to examining spatially uniform and non-uniform size distributions, and modelling their evolution in time. In this way the parameteric dependence of the model can be explored for realistic hydrodynamic and sedimentary inputs. This is an important step toward placing bounds on sediment transport rates and erosion/accretion potentials along proposed pipeline routes.

7.5 REFERENCES

- Ackers, P. and W.R. White, 1973. Sediment transport: new approach and analysis. ASCE, J. Hyd. Div., HY11, p. 2041-2060.
- Amos, C.L. and E.L. King, 1984. Bedforms of the Canadian Eastern Seaboard; a comparison with global occurrences. Marine Geology, 57, pp. 167-208.
- Bijker, E.W., E.V. Hijum and P. Vellinga, 1976. Sand transport by waves. Proc. 15th Coastal Engineering Conf. Hawaii, Chapt 68, ASCE, NY, pp. 1149-1167.
- Chriss, T.M. and D.R. Caldwell, 1982. Evidence for the influence of form drag on bottom boundary layer flow. J. Geophys. Res., 87, pp. 4148-4154.
- Dally, W.R., R.G. Dean and R.A. Dalrymple, 1984. Modelling Wave Transformation in the Surf Zone. Coastal Engineering Research Centre, U.S. Army, Misc. Paper. CERC-84-8.
- Einstein, H.A., 1950. The bedload function for sediment transport in open channel flows. Soil Conservation Service, U.S. Dept. of Agriculture, Tech Bulletin 1026, 78 pp.
- Engelund, F., 1981. The motion of sediment particles on an inclined bed. Prog. Report 53, Inst. Hydrodyn. and Hydraulic Engrg., Tech. Univ. Denmark, pp. 15-20.
- Evans-Hamilton, Inc., 1976. Final Report of Study of Sand Waves on Sable Island Bank. Unpublished Manuscript Prepared for Mobil Oil Canada, Ltd. April 16, 1976.
- Fredsoe, J., 1977. Settling of Suspended Sediment in Dredged Regions. Unpublished Manuscript Prog. Report 43, Inst. Hydrodyn. and Hydraulic Engrg., Tech. Univ. of Denmark.
- Grant, W.D., A.J. Williams, S.M. Glenn, D.A. Cacchione and D.E. Drake, 1983. High Frequency Bottom Stress Variability and Its Prediction in the CODE Region. CODE Technical Report NO. 15, WHOI-83-19.
- Gust, G. and G.L. Weatherly, 1985. Velocities, turbulence, and skin friction in a deep-sea logarithmic layer. J. Geophys. Res., 90, pp. 4779-4792.
- Hay, A.E. and D. Heffler, 1983. Design considerations for an acoustic sediment transport monitor for the nearshore zone. National Research Council Canada, C2S2-4.
- Huntley, D.A., 1982. In situ sediment monitoring techniques:

- a survey of the state of the art, U.S.A. National Research Council Canada, Rept. C2S2-1.
- King, L.H., 1970. Surficial geology of the Halifax-Sable Island Map Area. Marine Science Paper No. 1, Energy Mines and Resources, Canada, 16 pp.
- Lesht, B.M., T.L. Clarke, G.L. Freeland, D.J.P. Swift and R.A. Young, 1980. An empirical relationship between the concentration of resuspended sediment and near-bottom wave orbital velocity. Geophysical Research Letters. 2, 1049-1052.
- Martec Limited, 1982. Sediment Transport on a Continental Shelf. Atlantic Geoscience Centre, Energy, Mines and Resources, Canada. 60 pp.
- Martec Limited, 1983. A 2-D sediment transport model for continental shelves. Atlantic Geoscience Centre, Energy, Mines and Resources, Canada.
- Moir, J., 1986. Some Recent Changes in Island Design and Construction for the Beaufort Sea. Presented at a workshop on Coastal Engineering and Coastal Processes on the Canadian West Coast and the Beaufort Sea, ACROSES, February 1986, Vancouver, Canada.
- Pinchin, B.M., R.B. Nairn and K.L. Philpott, 1985. Numerical Estimation of Sediment Transport and Nearshore Profile Adjustment. Beaufort Sea Coastal Sediment Study. Report Prepared for the Northern Oil and Gas Activities Plan (NOGAP), Dept. Indian and Northern Affairs and Energy, Mines and Resources, Canada by Keith Philpott Consulting Limited.
- Resio, D.T., 1982. Wave prediction in shallow water. Proc. Offshore Technology Conference, Houston, Paper No. 4242.
- Shepard, F.P., 1954. Nomenclature based on sand-silt clay ratios. J. Sed. Petrol., 24, (3), p. 151-158.
- Vincent, C.E., R.A. Young and D.J.P. Swift, 1982. On the relationship between bedload and suspended sand transport on the inner shelf, Long Island, New York. J. Geophys. Res., 87, 4163-4170.
- Vilks, G., F.J.E. Wagner and B.R. Pelletier, 1979. The Holocene Marine Environment of the Beaufort Shelf. Geological Survey Bulletin 303, Energy, Mines and Resources Canada, 43 pp.

APPENDIX I

English Translation of Chapter 4
Tracer Techniques by Bernard Long



CHAPTER 4

TRACER TECHNIQUES

by

BERNARD LONG

INRS - Oceanology
University of Quebec

4.1 INTRODUCTION

The problem of particle transport by hydrodynamic agents (currents and tides) is not resolved by the various transport equations in the literature. However, numerous experiments conducted under a broad range of conditions show that sediment tracers often constitute a unique means for qualifying or quantifying sediment transport. Natural tracers have revealed the major transport paths along the shore, such as the direction of littoral drift (McLaren, 1981) and sediment emplacement by paleo-waterways on the continental shelf (Hudson and Ehrlich, 1980; Ehrlich et al., 1980). More specific studies to deal with civil engineering problems were conducted using artificial tracers. For example, when there is sediment transport, the transport resulting from the combined effect of the various hydrodynamic parameters can be estimated by means of the data collected by in situ experiments. The results obtained thus account for all forces acting within the medium, including those usually ignored in theoretical or numerical assessments (Caillot, 1979).

Using this integrating, global method, it is rarely possible to measure specific parameters, such as the friction velocity (u_{*}) or the bottom roughness coefficient (k_s). On the other hand, some highly specific experiments have shown the role of sedimentary patterns in transportation. These experiments (Vernon, 1966; Long, 1977) revealed the nonuniformity of bottom transport and paved the way for tracer diffusion models to assess the uniformity and homogeneity of seabeds.

This report is not an exhaustive review of the entire bibliography covering this type of study. It merely analyses the various techniques developed in coastal, estuarine or river environments, and extrapolates these techniques to the continental shelf. Indeed, these techniques were often closely linked to the development of coastal civil engineering projects, and were therefore tested for shallow-water work. For the last few years isolated experiments (Vernon, 1966; Got, 1970; Longuemard, 1972); Bratteland and Brunn, 1974; Caillot et al, 1975), have been carried out at depths of less than 20 m and the results were often only descriptive.

4.2 REVIEW OF THE VARIOUS TRACING METHODS

Tracers are subdivided into natural tracers, which give an overall idea of transport over a long period of time (geological scale), and artificial tracers developed in order to obtain an instantaneous view of sediment displacement. The duration of such experiments may range from a few minutes (within the outfall zone along the coast) to one year (offshore experiments in the

North Sea (Bratteland and Brunn, 1974)). There are two main tracer types in use: fluorescent tracers and radioactive tracers. Other methods only constitute isolated technical tests that have never led to development of a scientifically and economically reliable technique. These techniques make use of neutron activation, thermal light emission or magnetic sediments.

a) NATURAL TRACERS

This approach consists of using the distribution patterns of certain natural markers along the shore and on the continental shelf. Without citing the literature in detail, we shall mention some research projects that used heavy minerals, sediments of varying sizes and shapes, and radioactivity - either natural (from various sedimentary stocks), or artificial (from nuclear power plant wastes).

i) Heavy minerals

Heavy minerals are often used as indicators of the origin of sedimentary stock, such as when tracing the origin of sand on the Santa Barbara beaches (Trask, 1952), on the coast of Rhode Island (McMaster, 1966) and of Monterey (Sayles, 1966). They are used for determining on a larger scale the overall sediment dynamics, as in the work by Judge (1970) between Monterey and Los Angeles, or by Ross (1978) between Nova Scotia and New Jersey on the US continental shelf and slope.

In view of the specific characteristics of some types of sediment (mineralogy), some authors have used these natural stocks as artificial tracers (Kidson and Carr, 1962).

ii) Grain size and shape

Based on the specification of the various sediment populations, factors such as the granulometry or the shape of particles can be used as natural tracers. Indeed, the distribution of these various sedimentary stocks is based on their source (Friedman, 1961; Barousseau and Long, 1978; McLaren, 1981) and on hydrodynamic factors (Friedman, 1967; Klovan, 1966; Visher, 1969; Chambero and Upchurch 1979). Recently, Bridge (1981) established a model of the granulometric distribution of sediment transported as bedload and showed the effect of the various parameters upon the granulometric curve (shear, viscosity). Based on a study of the grain shape, Ehrlich et al. (1974), Rice et al. (1976), Markovich et al. (1976), Porter et al. (1979), Ehrlich et al. (1980), Brown et al. (1980), Hudson and Ehrlich (1980) and Clark and Osborne (1982) have shown that detritic quartzes can be used as natural tracers. Indeed, a study of the distance between the edge and the centre of gravity of the grain (48 measurements) shows that the initial grain shape corresponds to the first twenty harmonics of a Fourier series. Since each sedimentary population is represented by a particular value of each harmonic, for a given size population, a distinction can be made between sedimentary stocks that have different geological histories, such as those of the paleochannels in the continental shelf opposite the South Carolina rivers (Brown et al., 1980, Hudson and Ehrlich, 1980) or of the Gulf of Mexico (Markovich et al., 1976). Rice et al. (1976) have shown the relationship between the sand load dropped by the rivers and the composition of South Carolina beaches. Using the

same approach, Porter et al. (1979) and Clark and Osborne (1982) point out that the sand supply to Monterey beach is not due exclusively to the present accumulations by the Salinas River, but also, locally, to the recycling of the Flandrian dunes.

iii) Natural radioactivity

In the course of numerous nuclear tests and the development of nuclear power plants throughout the world, measurements of artificial radioactivity in the environment showed the feasibility of using natural radioactivity as a sediment tracer. By 1963, Huston and Byerly recommended the use of radioactive minerals to study sediment transport in California, and Bastin (1963) demonstrated the relationship between seabed lithology and natural radioactivity. Subsequently, Rivière (1965), Rivière and Vernhet (1966) and Minami (1965) demonstrated the significance of variations in natural radioactivity on Mediterranean and Japanese beaches. Grant Gross (1966) revealed the sedimentary plume of the Columbia River and Grant Gross and Nelson (1966) determined the major continental shelf transport pathways in the states of Washington and Oregon, based on the discharge of the Columbia River. Similarly, Olsen et al. (1980) have studied the sedimentary dynamics (transport and accumulation) at Barnegat Bay (New Jersey).

Simultaneously with the development of this technique, Kamel and Johnson (1963) and Tashjian et al. (1964) suggested the use of thorium as a radioactive tracer. Nevertheless, this method was quickly abandoned because the radioactive mineral, much like the various heavy minerals, has much too high a density and can

under no circumstances simulate the sedimentary transport of quartz sand.

iv) Conclusion

Although the major transport pathways under present hydrodynamics conditions can be determined using natural materials, transport within a limited area cannot. While the tracer is inexpensive, analysis of the samples is often lengthy and laborious and very seldom feasible in situ, except in the case of natural radioactivity measurements.

These tracers will therefore be used to determine, on a geological time scale, the pathways of metal-bearing placers. In this respect, highly accurate measurements of the natural radioactivity distribution made it possible to map the Bristol Channel (Miller and Symons, 1973), the Bay of Banyuls (Gaucher et al., 1974), the Pyrenean-Catalan continental shelf (Got, 1971; 1974) and the Ilmenite placers offshore Senegal (Thorn et al., 1973). However, it is impossible, under any circumstances, to use these types of tracers to determine present day sedimentary transport.

b) ARTIFICIAL TRACERS

Unlike natural tracers, which are a part of the environment and which respond according to the hydrodynamic conditions that have positioned them, an artificial tracer must be chosen in relation to the environment. This implies that use of this type of tracer to simulate sediment transport must take into account the hydrodynamic conditions of the environment. Specifically, the tracer must respond in a manner identical to that of the

sediments that comprise the substrate; to that end, a test involving bedload transport measurement can only give valid results if conditions of good mixing, as defined by Courtois (1964) and by Courtois and Sauzay (1970), are met.

The criteria governing the choice of tracer were defined by Nelson and Coakley (1974):

- 1) The tracer must be different from the materials comprising the surrounding environment: it must be strong and stable.
- 2) It must have the same hydrodynamic and mechanical properties as the surrounding sediments.
- 3) It must be detectable at low concentration in order to reduce as much as possible the amount of material to be used.
- 4) It must be temporary in order to be able to run other tests in the same environment without worrying about sediment contamination. On the other hand, its reduction or use rate must be fully known.
- 5) It must be inexpensive.
- 6) It must be non-toxic to man and to the aquatic environment.

For data interpretation, two different, complementary approaches that yield two different types of results are used with artificial tracers:

- Qualitative studies that simply interpret tracer movements by study the variations in the shape of the contours of constant concentration per unit surface area.
- Quantitative studies designed to determine overall the amount of material carried during sediment displacement due to the effect of the various hydrodynamic agents. The second approach

should become increasingly popular, as it yields actual measurements of sediment movement, thus making it possible to verify the physical or mathematical models developed on the basis of physical data.

Prior to dealing specifically with the study of the main artificial tracers used in sediment dynamics, i.e. luminescent or fluorescent, radioactive, magnetic or neutron-activated tracers, we must describe in a general manner various practical techniques in common use, namely: sediment tagging, injection, detection of tracer material, and data interpretation. For each of these aspects, an evaluation of the various methods will be made in order to determine which ones can be used for tracer studies on the continental shelf.

i) Sediment tagging

The tagging of particles to be injected into the environment must always be considered in terms of future detection. The tracer must be easily distinguished from natural sediment. However, tagging procedures should not alter the mechanical and hydrodynamic properties of the sediment.

Three approaches are used to manufacture a sediment tracer: surface coating of particles from the test site, creation of an artificial particle where the tracer is included in the particle, and injection of tagged product into the mineral inclusions that constitute the basic sediment (xenonation or kryptonation). There are other approaches for tagging either fine sediment of less than 4 phi, or of pebble-size sediments, but we shall only examine sandy sediment here (Table I).

The third approach is used in the case of radioactive

TABLE I

Different methods of radioactive labelling and their applications (after Tola, 1982).

METHOD	DEFINITION	LABELLED MATERIALS	DIAMETER	RADIOACTIVE γ ISOTOPES	APPLICATIONS
INCORPORATION	INSERTION of RADIOACTIVE METAL WIRE into a drill whole which is sealed afterwards with heat-hardening resine.	- PEBBLES - GLASS + ARTIFICIAL materials	> 2 cm	^{182}Ta	- Transport of Pebbly by Mountain Streams - Velocity measures in two and three phase hydraulic models
BULK labelling by IRRADIATION	INCORPORATION of an (n, γ) ACTIVABLE element to molten GLASS which is then crushed to the size of the natural sediment concerned and IRRADIATED in a nuclear reactor	GLASS, for SAND SIMULATION	40 μm - 200 μm	^{198}Au ^{147}Nd ^{51}Cr ^{192}Ir ^{182}Ta ^{46}Sc	Studies on BED-LOAD Transport of SAND
SURFACE labelling by DEPOSITION	DEPOSITION of Radioactive Isotope on the SURFACE of the grains by CHEMICAL treatment	- SAND - PELITIC sediments (SILT, CLAY, MUD) - ARTIFICIAL materials (Polystyrène, Bakélite, Nylon Fibres)	60 μm - 200 μm < 40 μm	^{198}Au ^{192}Ir ^{51}Cr ^{46}Sc ^{113}In	- Studies on BED-LOAD Transport of SAND - Studies on Transport of SUSPENDED Sediments - Hydraulic Scale Models and Channels

tracers. It was developed by the Oak Ridge National Laboratory (Fig. 4.1) based on the method proposed by Carder (1966). This method consists of diffusing at high temperature and high pressure radioactive krypton (Kr-85) into the particle (usually quartz). The maximum penetration of krypton into the solid is from 0.1 to 10 μm . This operation creates a new material that is stable at environmental temperatures. A similar approach can be used for Xe-133 (Duane and Judge, 1969 and Airee et al., 1969 in Duane, 1970). Resistance to abrasion and surface wash is good, losses being 3.5, 4.8 and 5.5 %, respectively, after 28, 75 and 219.5 hours of washing and 4.4., 5.65 and 6.3 % after tests of 28, 75 and 219.5 hours, respectively of continued washing and erosion. The authors specify that these losses are identical to those obtained using Ba-La140 and Cr51 solution surface coatings (loss of 1% by washing and 4% by abrasion). The problem with this method is therefore not so much the quality of the tagging, but rather the difficulty in incorporating into the sedimentary matrix a sufficient amount of tracer. Therefore, for its second test series, the RIST (Radio-isotropic Sand Tracer Study) program chose a surface-distributed tracer (Duane, 1970).

Surface tagging is the most frequently used technique for fluorescent tracers, and it is often used with radioactive tracers. Lean and Crickmore (1963) did a comparative study of the two tagging systems from the hydrodynamic point of view. They mention that after some time (32 hours) tracer segregation occurs in the regions near the injection zone (first 20 metres) whereas in areas further away the two tracers exhibit the same

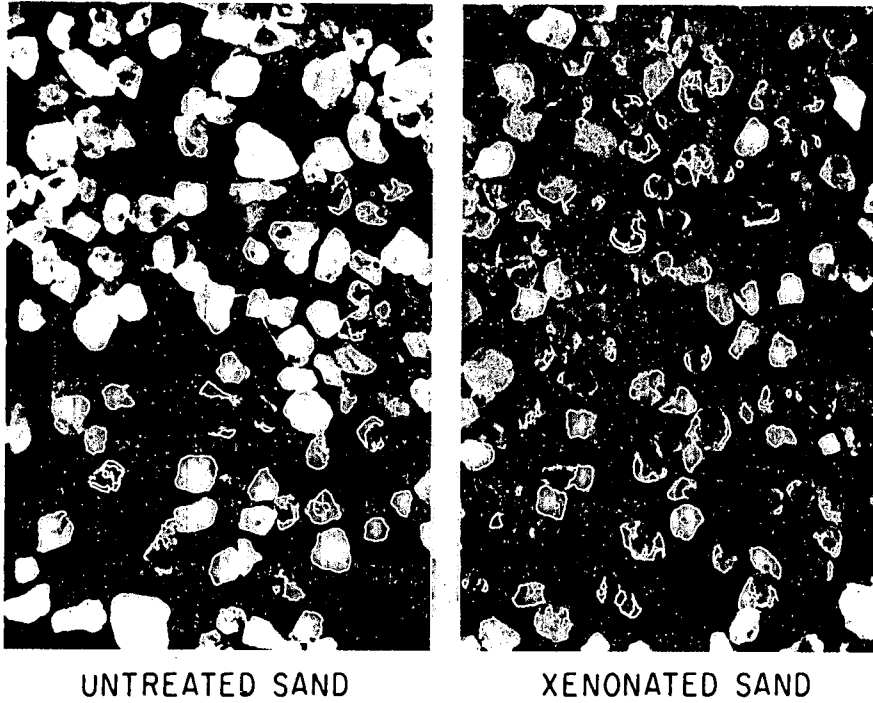

Fig. 4.1 Comparison of xenonated sand with untreated sand from the same area, mean size 2.0 phi (0.25 mm) (after Duane and Judge, 1969).

behaviour.

This tagging technique consists of coating sediment particles collected at the injection site with a fine film of radioactive material or dye. This is a very elegant procedure, as it preserves the morphology of the grains. However, it alters very slightly the mean diameter (by the thickness of the coating) and it changes the roughness coefficient of the grain by obstructing the small irregularities that constitute the surface of the grain. In fact, these two drawbacks alter very little the hydrodynamic qualities of the grains. The major drawback of this technique is due to two factors:

- Grain abrasion during transport directly affects the surface coating and thus the quantity of tracer that will be detected later. Substantial loss of information may result because the fine particles dislodged from the surface of the grains migrate faster than the grains themselves and may artificially create an expansion of the tagged cloud and thus an overestimate of sediment transport.

- The coating, and therefore the amount of tracer, is proportional to the surface area of the particles rather than to their weight. Nelson and Coakley (1974) have shown that, for spherical particles, the amount of tracer A used per unit of weight relative to the weight of the particle (M) is:

$$\frac{A}{M} = \frac{K}{\rho_s} \frac{4\pi r^2}{4/3\pi r^3} = \frac{3K}{\rho_s r}$$

where r is the radius of the particle, K the amount of tracer per unit of area, and ρ_s the density of the particle.

For these reasons, this procedure attributes much more

weight to small particles than to large ones. Thus, as a first approximation, since small particles are likely to migrate faster than large ones, this method overestimates transport, as is the case (to a lesser degree) with erosion of the surface coating. It is therefore impossible to use natural sediment to achieve a tagging proportional to the weight of sediment.

Tagging artificial elements preserves the ratio between the amount of tagging material and the weight of sediment tagged. Such artificial sediments are used for all types of tagging substances. They are generally available on the market for fluorescent tagging substances, as glass (Nelson and Coakley, 1974; Caillot et al., 1977), in yellow only, and commercial resins. In both cases, their cost is high given the amount of tracer to be used (see the "Sampling" section). In the case of radioactive tracers, there are numerous types of glass on the market (Caillot, 1970); the composition of some glasses is shown in Table II. These glasses are ground to the size of the test site sediment; the size interval selected usually represents the middle portion of the granulometric distribution curve in order to avoid additional complexity in interpreting grain dispersion. Indeed, during transport, granulometric sorting will occur and the smaller particles will migrate further; they could therefore cause a wider dispersion of tracer and an overestimate of sediment transport. The cost of radioactive glass is high but, used in small amounts, it compares to the manufacturing cost of large amounts of fluorescent tracers obtained by surface tagging. In tests requiring one ton of luminescent tracer, the use of 1 kg of glass is sufficient and the cost will be one-quarter of the

TABLE II

Various glass compositions suitable for radioactive labelling
(after Caillot, 1970).

	VERRES A			
	Iridium*	Or*	Chrome*	Tantale*
SiO ₂	48%	50.5%	48%	40%
Al ₂ O ₃	19	20	22	12
CaO	17	18	14	13
TiO ₂	5	5.25	5	3
MgO	-	6.25	6	5.5
K ₂ O	5	-	-	5
BaO	-	-	5	6.5
Ir	0.25-0.30	-	-	-
Au	-	0.04-0.5	-	-
Cr	-	-	3	-
Ta ₂ O ₅	-	-	-	15

former.

ii) Injection

Once it has been prepared, the tracer must be injected into the environment. Various techniques are used to this end; each technique is suited to the type of tracer used and the amount of material to be injected.

In all cases, disturbance of the environment by the tracer must be minimized. The use of large amounts of tracer will modify the morphology of the seabed by creating a deformation of the seabed, which will no longer be in equilibrium with the environment. Therefore, at the very beginning of the experiment, the observed tracer movement will be due exclusively to the erosion of this artificial obstacle. This is a very important problem because, on the continental shelf, only storm waves rearrange the sediments and it is therefore likely that several storms will be required for a good mix of tracer in sediments. Courtois and Sauzay (1966) and subsequently Alquier et al. (1970) defined the concept of "good mix" by analyzing the flow rates relative to the velocity of the centre of gravity. Good mix conditions are reached when:

$$\int_0^T C dt = \text{constant}$$

regardless of the test location. In this equation, C is the concentration by weight of tracer per unit of volume at time t, and interval [0,T] is chosen so that the tracer cloud fully crosses the measurement cross-section during that time interval.

Thus, after a transient state, during which the characteristics of the phenomenon are dependent upon the initial injection conditions, a permanent, stable or unstable mode appears that no longer depends upon initial conditions but only upon environmental conditions (hydrodynamic factors) which define the solid flow rate.

We shall examine the major techniques used, as regards both the method and the means used for tracer immersion.

The tracer may be immersed from soluble plastic bags (Schulz and Pillot, 1965; Duane, 1970; Ingle and Gorsline, 1973), or from containers being emptied by a diver (Vernon, 1966), or by means of an injection system (Crickmore and Lean, 1962; Crickmore, 1964; Duane and Judge, 1969; Durham and Goble, 1977), or by means of an immersion system (Suazay, 1968; Caillot, 1979; Tola, 1982; Long and Drapeau, 1983) (Fig. 4.2) opened on the seabed or above the seabed.

The injection may be made in a straight line, provided that the sediment transport is uniform (Duane, 1970), or in spots, when the sediment is moving very fast (Courtoise, 1964), or as a cloud of a few tens of m^2 in case of low-rate or intermittent transport. The latter method, proposed by Caillot (1979) and Tola (1982), seems the best suited for deep studies because the chances of detecting the cloud are far greater. Spot immersions made by Vernon (1966) and Cook (1966) in California; by Bratteland and Brunn (1974) in the North Sea and by Longuemard (1974) in the Atlantic required highly localized experiments, where the site was very accurately specified. Sampling was done either by diving, for the first three authors, or from a fixed

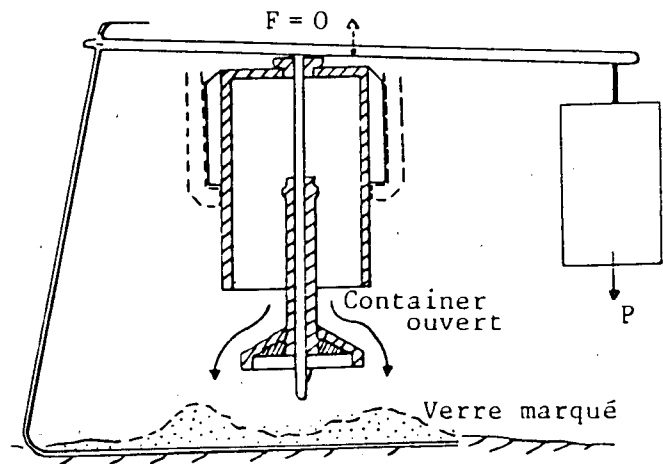
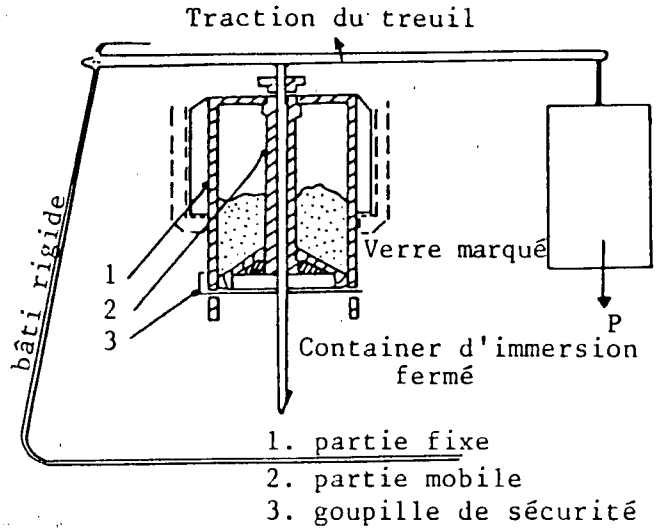
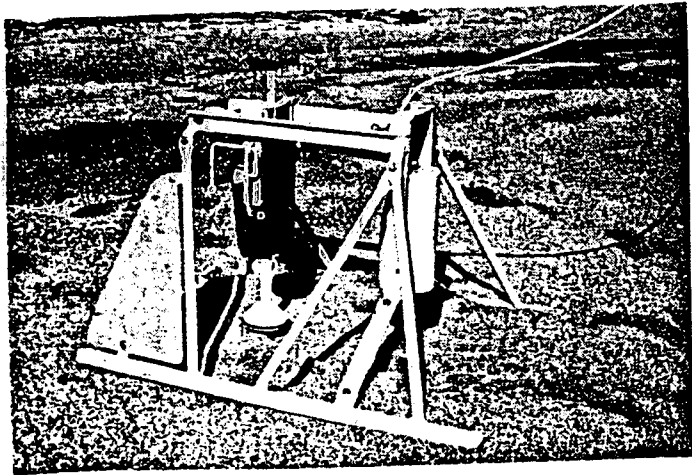

Fig. 4.2 The radioactive tracer deployment system proposed by Sausay (1968).

station in the case of the last author. Such studies could become very much a hit-or-miss proposition if there is substantial rearrangement of the seabed following a major storm, as tracer dispersion will then be far too great to be sampled within such a limited predetermined grid.

iii) Detection

Sampling of the tracer cloud constitutes the most delicate part of an experiment as it determines the quality of the data collected. Whereas in a river the sampling plan is relatively easy to set up because the current is one-way, at sea the grid becomes more complex and the number of samples required is much greater because the operator cannot predict the direction of transport.

The amount of tracer to be injected and the sampling step size are therefore interrelated and they depend upon the spatial dispersion of the tracer, its immersion depth and the sampling mode (Tola, 1982). De Vries (1966) showed in a theoretical calculation of the number of samples required that the relative error of the concentration measurements is inversely proportional to the square root of the number of tagged grains in the sample. He concluded that a minimum of 100 tagged particles are required per sample collected in order to have an error of only 10%. Similarly, Courtois and Sauzay (1970) demonstrated that, depending on the type of detection, the quantity of tracer used must vary by a factor of 100.

Various sampling schemes have been used; these include:

Point by point sampling: This sampling mode is used primarily with fluorescent, thermoluminescent or neutron-activated tracers. It consists of collecting samples either on submerged grease-coated plates (Ingle, 1962; Vernon, 1966; Ingle and Grosline, 1973), or by means of small (187.5 cm³) buckets (Inman et al., 1980; Gable, 1981), or by core sampling (Inman et al., 1980) (Fig. 4.3). The sampling plan, adjusted according to the assumed sediment transport directions, is either star-shaped (Greenwood, 1979; Gillie, 1983), or a grid comprising several radials (Ingle, 1962; 1966; Inman et al., 1980). These various techniques involve a substantial number of samples for analysis. Nelson and Coakley (1974) estimated that at least 100 to 200 samples are required per detection. Moreover, these techniques require that the sampling grid be perfectly surveyed in order to carry out either temporal or spatial analyses as defined by Inman et al., 1980. Such tests can only be done at intertidal sites or along easily accessible beaches. In general, the samples will only be analyzed following a sometimes lengthy, laborious treatment in the laboratory; this means that there is no control aboard ship to guide the detection scheme in the event of a change in sediment transport direction. A method without field verification must be rejected for continental shelf work.

Static detection: Static detection as defined by Courtois and Sauzay (1970) and Nelson and Coakley (1974) is used primarily with radioactive tracers. It was used in Australia by Campbell (1963, 1964), Campbell and Seatonberry (1967), in Yugoslavia by Vukmirovic et al., (1964), and in Canada by Durham and Gable (1977). Due to the small coverage analyzed per sensor, this

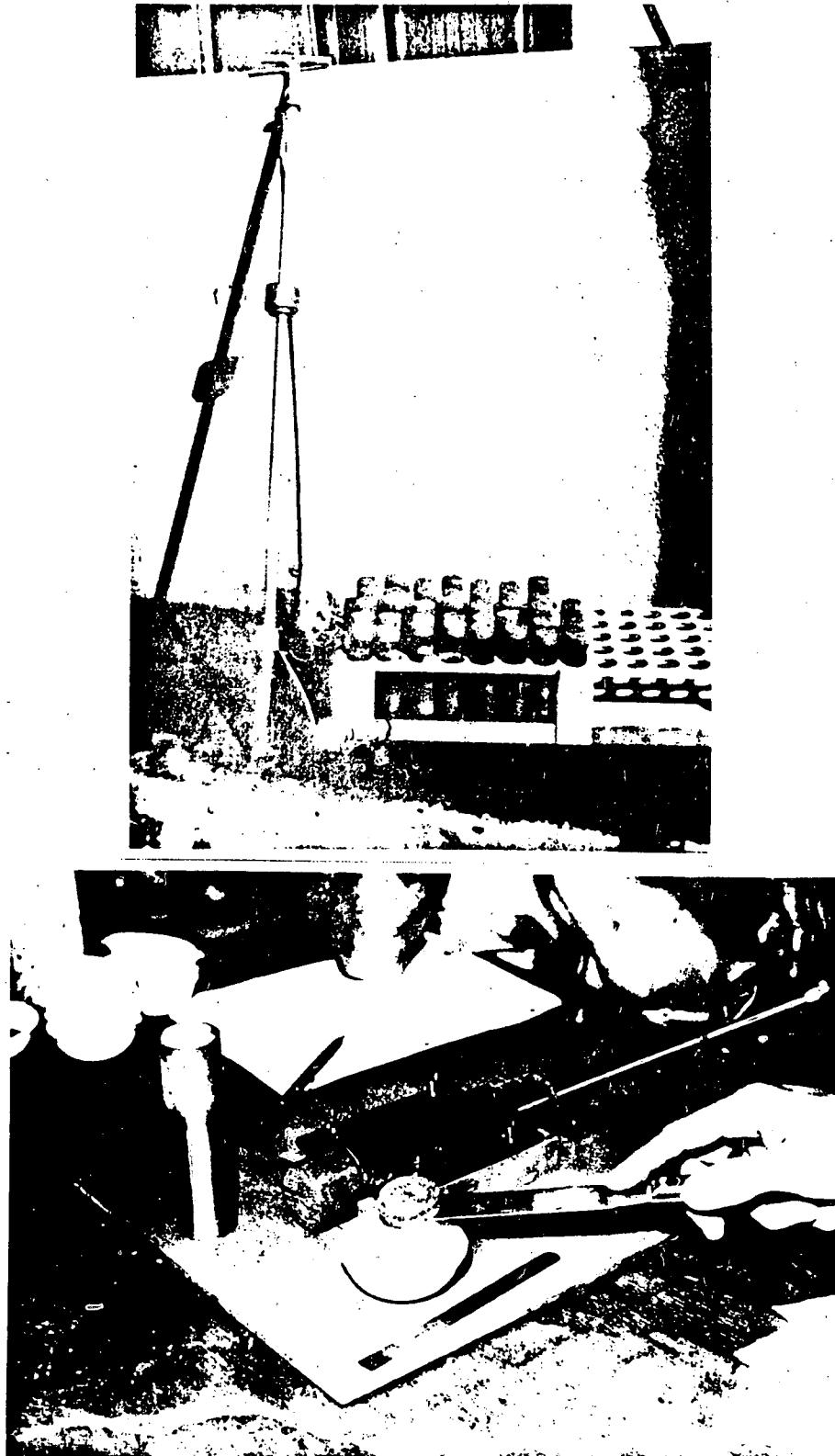

Fig. 4.3 Core sampling methods used in tracer experiments (after Inman et al., 1980).

method requires the use of a much larger amount of tracer than that required by dynamic detection (a factor of 10). On the other hand, it does not allow a switch in the sampling grid, and therefore it assumes in advance a certain transport direction. This method, developed for shallow areas, is promising for the detection of the evolution of the tracer versus time at one point; it should allow calculation of the role played by sedimentary patterns in bedload transport.

Nevertheless, as originally designed, it seems highly impractical for the continental shelf. Longuemard (1974) developed an autonomous detection grid (Fig. 4.4) equipped with 36 (Geiger Muller) counters with a 17 m span. This experimental system has only been used briefly at a depth of 28 m, but it would appear that for the continental shelf, if sediment transport is low, this autonomous station has a future (Fig. 4.4).

Dynamic detection: For dynamic detection, the detector is mounted on a sled that is towed throughout the study area. In the course of its travel, the detector covers a very large area and it has the opportunity of detecting an infinite number of tagged grains. Due to the presence of highly compact data acquisition systems, this detection mode is the most commonly used for radioactive tracers (Duane, 1969; Duane and Judge, 1970; Sauzay, 1968; Courtois and Monaco, 1966; Lavelle et al., 1978; Heathershaw, 1980, 1981; Long and Drapeau, 1983; Drapeau and Long, 1984). Case et al. (1971) estimate that 2% of all the tracer deposited on the bottom can be detected within one hour

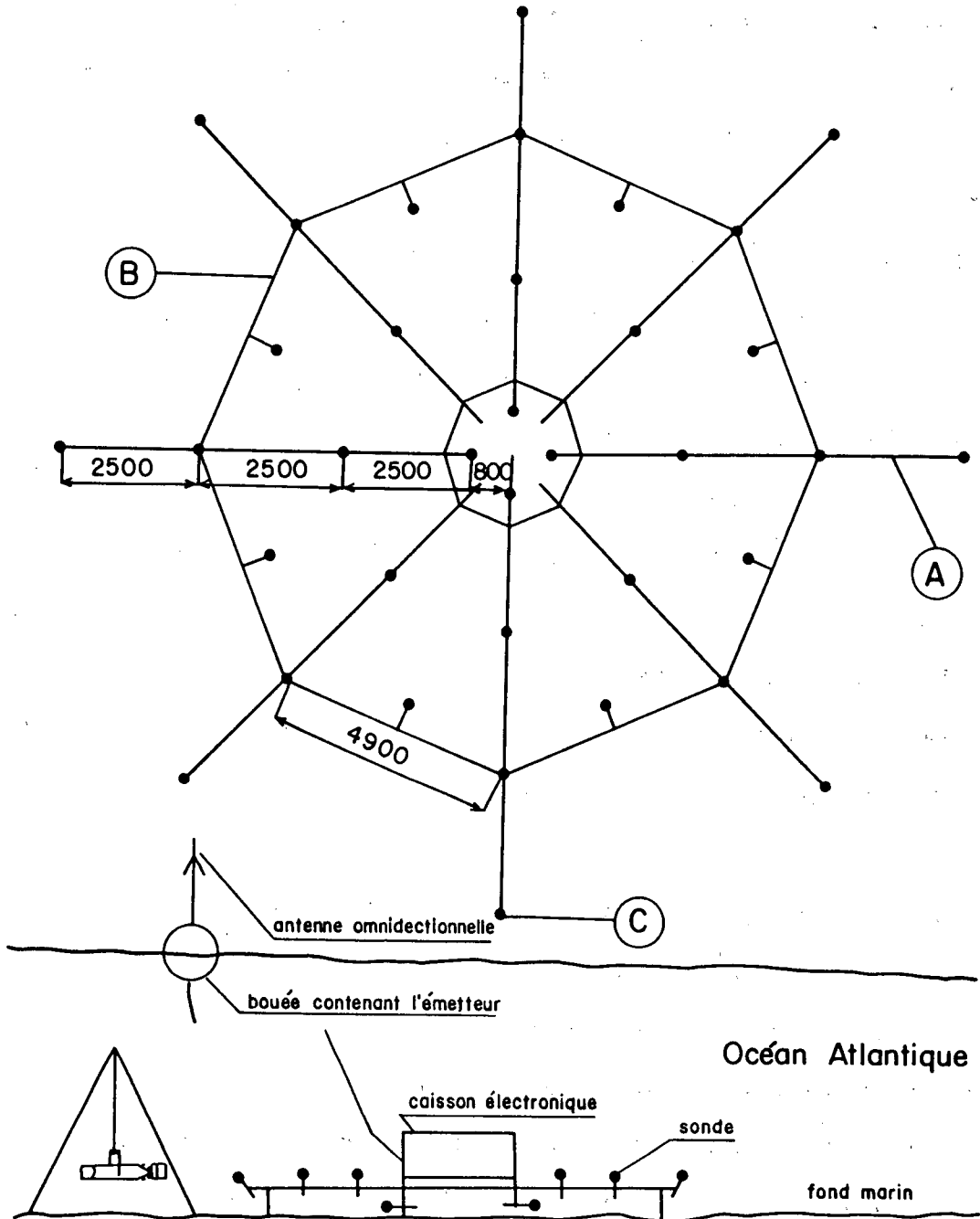

Fig. 4.4 Automatic data acquisition system used on the continental shelf by Longuemard (1974).

over an area of $300 \times 600 \text{ m}^2$, which would correspond to the equivalent of 50,000 samples collected with a Shipek bucket (Nelson and Coakley, 1974). The accuracy of this method is directly proportional to the number of cross-sections through the cloud and it makes it possible to change the movement of the ship depending on the results. The results are collected continuously, usually at the rate of one value per second. They are processed partly on the ship and the output is graphic and analog. Isoconcentration charts can be obtained on the ship after microcomputer processing of the data. This approach is therefore the most attractive for continental-shelf work, the only problem to be solved being the positioning of the sledge on the bottom relative to the ship, at great depths. Lavelle et al. (1978) estimate that 107 m of cable are required to work at 21 m, while Duane and Judge (1969) calculated that a 60 m (200 ft) cable allows detection at the speed of 4 knots and a depth of 25 m (80 ft). If the speed rises to 6 knots, the maximum depth sounded will be 16 m (55 ft). These various results reflect the role played by the shape of the detection apparatus.

Courtois and Sauzay (1970) believe that, for the three different sampling methods (spot sampling, static and dynamic sampling), the amount of tracer to be used is of the order of 100/10/1. Therefore, Tola (1982) and Caillot (1979) believe that using 500 to 1000 g of radioactive sediment is sufficient to successfully complete tracing tests in the dynamic mode, whereas Bratteland and Brunn (1974) used 90 kg of tracer in the case of spot sampling.

iv) Data interpretation

The processing and interpretation of the data depend upon the detection mode described above. In general, they all use electronic detection of the tagged material. The signal is usually translated into photons (Table III).

Qualitative studies: These studies consist of plotting the isoconcentration lines of the tagging substance and of visually determining the transport pathways. These contours, however, are often highly approximate, given the spacing between the various samplings. Vernon (1966) showed that sedimentary transit is directly affected by the sediment pattern; however, the sampling grids determined in advance do not allow a guess at the positions of these patterns. Most authors who have carried out sediment tagging tests have limited themselves to this type of result because the percentage of tagged grains counted relative to the grains injected is so low that no calculation can be undertaken statistically. This is especially the case with the majority of tests using fluorescent tracers. McLaren and Buckingham (1983) for instance estimate that 90% of the paint used to tag the injected grains was lost after 48 hours and that 50% of the remaining paint was lost after 15 days, during a test carried out in the Fraser Delta.

Quantitative studies: These studies have been undertaken based on tests using radioactive tracers. Crickmore and Lean (1962a and b, 1963) were the first to develop integrating methods, then Courtois (1966, 1970), Sauzay (1968) and Courtois and Sauzay (1965, 1966) defined the count rate balance method. This method was refined by Courtois and Monaco (1968, 1969),

TABLE III

Sediment labelling methods after Nelson and Coakley (1973).

MARQUEUR	NATURE DU SIGNAL DÉTECTÉ	NATURE DU MARQUAGE	«IN SITU» DÉTECTION POSSIBLE?
1. Radionucléides	photons, (MeV)	actif	Oui
2. Peintures luminescentes	photons, (eV)	activable	Oui
3. Chimique: détecté par			
a) Absorption atomique	photons, (eV)	activable	Non
b) Neutro-activation	photons, (MeV)	activable	Non
c) Fluorescence R.X	photons, (eV)	activable	Non
4. Thermoluminescence	photons, (eV)	activable	Non
5. Radiophotoluminescence	photons, (eV)	activable	Possible

Courtois and Sauzay (1970) by defining the optimum amount of tracer to be used. Since then, numerous authors have used it to define bedload transport (Caillot et al., 1975; Long 1977; Caillot, 1979; Heathershaw, 1981; Duane and James, 1980; Lees, 1983).

This method relaunched by Caillot (1979) is designed to ascertain the transport rate through a cross-section orthogonal to the resultant direction,

$$q = \rho L_t V_m E_m \quad (4.1)$$

where q is the transport rate (tons/day).

ρ density of the sediment,

L_t the width of transport (metres),

V_m the mean transport velocity (metres/day),

E_m the transport thickness, i.e. the mean value of the distance between the bed surface and the most deeply-embedded radioactive grains.

In order to solve this equation, V_m and E_m must be determined for a unit width $L_t = 1$ m.

Determination of the speed V_m : The cloud of radioactive particles is represented by a pattern of isopleths, the major axis (abscissae) of which coincides with the mean direction of transport. The cloud is then characterized by the position of the centre of gravity projected onto this extension axis. The evolution of the centre of gravity versus time obtained over successive detections determines the mean transport velocity V_m .

Examination of the V_m versus time curve reveals the conditions of tracer integration into the environment; the tracer

mixes slowly with natural sediments by "sliding" at the surface of the seabed. Once the "good mix" tracer conditions are obtained, transport is even and its apparent velocity usually decreases.

Determination of the transport thickness E_m : the formation of ripples or dunes or the collection of cores are indicators of the transport thickness E_m , but the second approach is not always technically or economically feasible (Waters and Thorn, 1975). The transport thickness may be estimated using the count rate balance method proposed by Sauzay (1967) and Courtois and Sauzay (1970). Indeed, the greater the mix thickness, the deeper the tracer immersion and the more the radiation emitted is absorbed and diffused. There is a relation between the number of photons N received by the detector, the activity A introduced and the burial depth E_m :

$$\frac{1}{\beta} \frac{\alpha}{f_0} \frac{N}{A} E = 1 - \exp(-\alpha E) \quad (4.2)$$

where α and f_0 are calibration coefficients for the detector used; f_0 corresponds to the ratio linking the activity readings (in decays per second: cps) to the activity of 1 μCi distributed evenly over a 1 m^2 circular flat surface centred underneath the detector and covered by a depth z of natural material, i.e.

$$f = f_0 e^{-\alpha z} \quad (4.3)$$

N represents the integration of all the count measurements, corrected for the bottom noise over the entire radioactive cloud, and is equal to:

$$N = \iiint nds \quad (4.4)$$

where n is the number of counts recorded per unit area and ds is the area element; A is the total immersed activity; β is a function of the burial E , known on the basis of the shape of the distribution of the depth concentration and β varies from 1.05 to 1.15 (Sauzay, 1968).

Other authors have developed different methods for determining sediment transport. These models were implemented both for laboratory (channel) study and field study: De Vries (1966, 1971) proposed two diffusion models to study the dispersion of fluorescent tracers, and Crickmore (1967) formulated a model for the study of radioactive tracers in rivers. Nelson and Coakley (1974) defined an overall approach based on the work of Crickmore and Lean (1962b and 1963). Other authors, Russel et al. (1963), Crickmore and Lean (1962a), Crickmore (1967) and Pilon (1965) used the laws of dilution to determine sediment transport. Lavelle et al. (1978) used a diffusion model that describes the sediment cloud on the basis of two dimensions:

$$\frac{\partial C}{\partial t} + V_x \frac{\partial C}{\partial x} - D_x \frac{\partial^2 C}{\partial x^2} - D_y \frac{\partial^2 C}{\partial y^2} = 0 \quad (4.5)$$

where $C(x,y,t)$ represents a concentration of tagged material at points x,y at time t , which have been subjected to advection from the source.

V_x represents the intensity of the sedimentary advection.

D_x and D_y the sedimentary diffusion coefficients.

Subsequently, Inman et al. (1980) determined two different approaches for measurements in the littoral zone, a temporal approach for measuring the velocity of littoral transport and a

spatial approach to determine the flow of materials transported (Table IV). Using these models, the results of sediment transport experiments using fluorescent markers can be used quantitatively and with improved accuracy.

In conclusion, the various interpretation methods are largely dependent upon the tracer used and the type of detection used. They are usually suited to specific situations and provide a fairly accurate estimate of sediment transport. The accuracy of the results obtained will depend upon the accuracy of the measurements made around the measurement centre point. For the continental shelf, if sediment transport is low, the tagged sediment cloud will be small and the position of the samples or of the detection sledge will be the greatest problem to be solved. Ship positioning should be measured with an accuracy of the order of 1 m rather than 10 m as with most positioning systems. On the other hand, the position of the probe or bucket must be fully known throughout the detection.

4.3 FLUORESCENT TRACERS

Luminescent or fluorescent tracers have been used for a long time, but the sampling method used to detect them has seldom passed the stage of point-by-point sampling. Only two automatic in situ measurement systems seem to have been developed, the first one (Nelson and Coakley, 1974) being developed by Kullenberg at the Institute of Physical Oceanography of the University of Copenhagen. This system was tested in Lake Ontario in cooperation with CCIW. The system consists of two watertight

TABLE IV

Analysis methods for data collected in tracer experiments (after Inman et al., 1980).

APPROCHE TEMPORELLE		APPROCHE SPATIALE
L'échantillonnage s'effectue à stations fixes suivant un pas régulier.		L'échantillonnage s'effectue suivant une grille pré-établie à temps fixe.
Intervalle simple	$\begin{array}{c} \cdot \quad \quad \quad \times \\ \cdot \quad \quad \quad \times \\ \cdot \quad - v_\ell \rightarrow \quad \times \\ \cdot \quad \quad \quad \times \\ \cdot \quad \quad \quad \times \end{array}$	$\begin{array}{cccccc} \times & \cdot & \times & \times & \times & \times \\ \times & \cdot & \times & \times & \times & \times \\ \times & \cdot & \times & \times & \times & \times \\ \times & \cdot & \times & \times & \times & \times \\ \times & \cdot & \times & \times & \times & \times \end{array}$
Ligne d'injection (Li) t ₀ , y ₀	Ligne d'échantillonnage (Le) 0 ≤ t _i ≤ ∞	† ligne d'injection · t ₀ , y ₀ ligne d'échantillonnage × -∞ ≤ y ₁ ≤ ∞
y _i est la distance entre Li et Le		

Conservation du traceur?

$$M = \int_0^{x_b} \int_{t_0}^{\infty} \frac{y}{x} Z_0 \bar{N} dx dt$$

$$M = \int_0^{x_b} \int_{-\infty}^{\infty} Z_0 \bar{N} dx dy$$

où: M représente la masse du traceur injecté et Z₀(x) l'épaisseur de la couche mobile

$$\bar{N}(x, y, t) i = \text{masse/volume}$$

i représente un échantillonnage particulier.

Les caractéristiques de la vitesse du transport littoral sableux sont:

$$v_\ell = \frac{1}{n \sum N_i} \sum N_i \frac{y_i}{x_i}$$

Le volume du flux sableux est:

$$Q_\ell = \int_0^{x_b} v_\ell Z_0(x) dx$$

La quantité de transport immergée est

$$I_\ell = Q_\ell (\rho_s - \rho) g N_0$$

photomultiplier tubes and an ultraviolet lamp. One of the tubes is used as reference and the other counts the radiation emitted by the luminescent grains. To date, no tangible results have been obtained with this system.

The second system, developed by the Institut de Geologie du Bassin d'Aquitaine of the University of Bordeaux (Caillot et al., 1977), is based on the same principle as the previous one, but this device has been, since 1978, at the laboratory prototype stage only and has not been used in the field.

For highly specific spot tests, Vernon (1966) used a diving camera and thus obtained the distribution of the cloud over one square metre at a depth of 30 m (Fig. 4.5).

All other tests using luminescent tracers were made by sampling based in a grid. Whereas along the shore tests made with relatively small amounts of tracers (5 kg per injection point) along a line comprising several points (5-6) in the NSTS program experiments at Santa Barbara (Inman et al., 1980) were unsuccessful, in the Fraser Delta 200 kg of tagged sand were used per point (McLaren and Buckingham, 1983) as well as 90 kg of sand at Ekofisk (Bratteland and Brunn, 1974). The tracer is prepared according to different methods depending on the colour desired. The cost of preparation was approximately \$10./kg for a preparation of 100 kg of tracer. The various colours available on the market are listed in Table V.

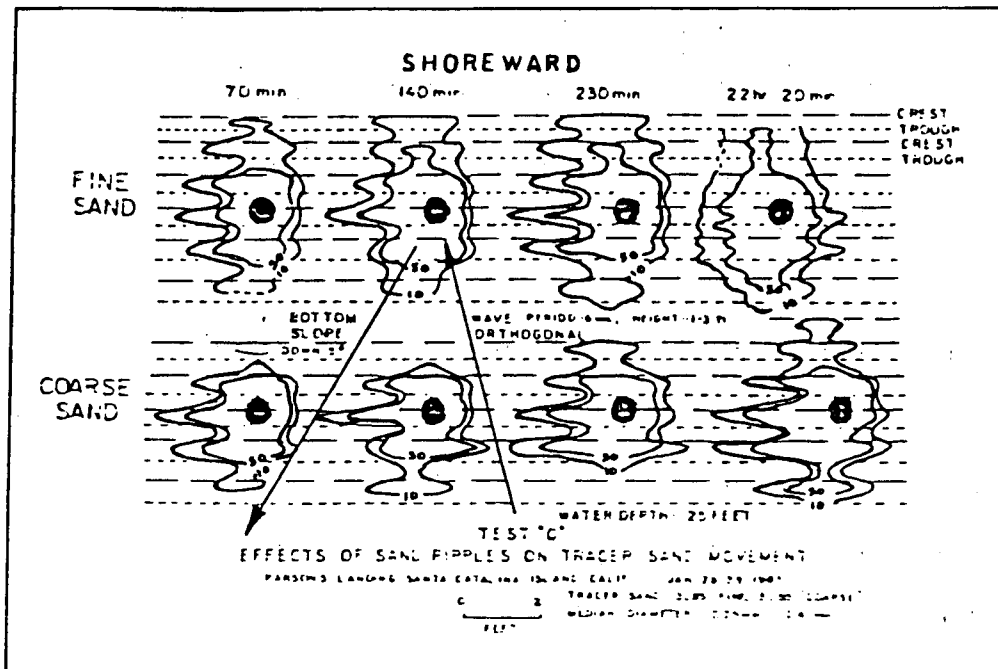

Fig. 4.5 Tracer dispersion patterns showing the influence of sand ripples (after Vernon, 1966).

TABLE V

Various luminescent paints used in sedimentology (adapted from Nelson and Coakley, 1974):

PAINT	COLOUR
Anthracene	Yellow-green
Lumogene	Red orange
Rhodamine B	Red
Rhodamine WT	Red
Primuline	Blue
Erosine	Orange
Auramine	Yellow
Victoria Blue B	Blue
Sudan I, II and III	Red
Day-Glo acrylic lacquers	Various colors

On the other hand, some companies (Saint-Gobain in France) manufacture luminescent glass ($\rho = 2.65$) containing 0.5% uranium oxide (U_3O_8) that emits, under ultraviolet lighting, an intense yellow coloring. Considering the high cost of this glass, the use of painted sediment remains the most advantageous solution.

Tracer immersion on the continental shelf is effected using various procedures. Jolliff (1963) opened a container on the seabed, Vernon (1966) used plastic bags opened by means of a cutter blade operating automatically upon contact with the seabed, Stuiver and Purpura (1968) used soluble bags while De Vries (1973) described a method using a frozen tracer, immersed as a brick that defrosts on the bottom. Lees (1979) used a pipe injection system that could inject 0.75 ton of tagged sediments at a depth of 17 m (Fig. 4.6). The tracer was spread 40 cm above the seabed.

Intepretation of the data is carried out in the laboratory using three different techniques:

- Manual counting of the luminescent grains in a darkroom, under UV lighting. This approach is always used because it is more reliable than the others (Inman et al., 1980). On the other hand, if the sample is dried, then sieved, the tagged grains can be distinguished according to particle size and it is therefore possible to analyze the various fractions separately (Lees, 1979).

- Counting of the luminescent radiation using an automatic device developed by Teleki (1967). This automatic analyzer was abandoned in recent tests in spite of the fairly rapid counting of a sample. Although it could be very useful for sample

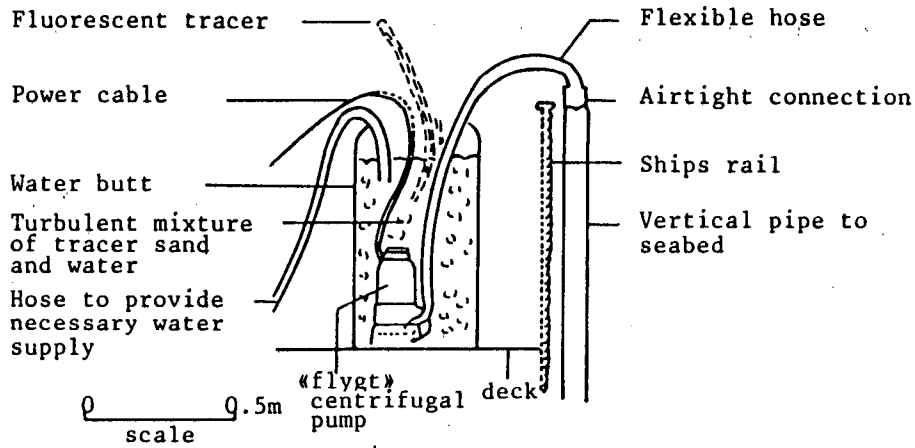

Diagram to show apparatus for injection of fluorescent tracer slurry onto seabed.

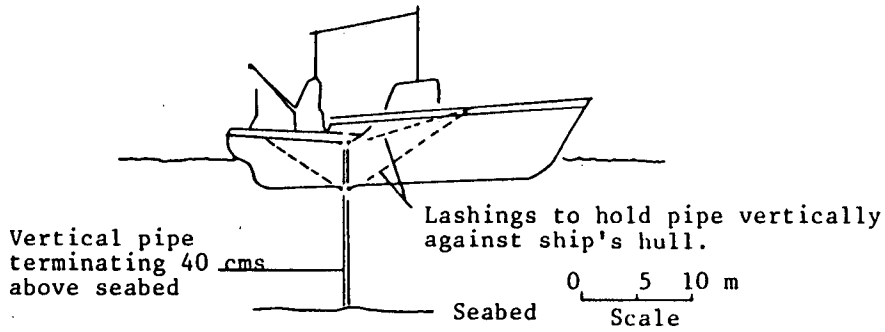

Diagram of RV «Edward Forbes» to show method of lashing pipe vertically against ship's hull.

Fig. 4.6 Luminescent tracer injection system for large tracer quantities (750 kg) (after Lees, 1979).

collected near the immersion point, where concentration of tagged sediments is very high, the procedure would become very cumbersome when attempting to count a few grains; a visual count would then be quicker.

- Using soluble paints in solvents, the tracer concentration can be determined by analyzing the dye concentration by means of a colorimeter. This technique seems attractive because it makes it possible to return to solution the entire paint contained in a sample, thus avoiding a surface count. However, it now seems that this method, used apparently successfully by Lees (1979), may not always work. McLaren and Buchingham (1983) mention that paint coating tends to disappear. They determined that 9% of the paint is lost during the first 48 hours and 5% of the remaining paint over the 15 following days.

These three different interpretation methods require careful laboratory work because the number of samples to be collected is substantial (approximately 200). However, the methods using portable fluorometers (Yasso, 1962) are not suited for the continental shelf because these systems are not watertight. On the other hand, weak radiation in situ cannot be detected by means of a photoelectric cells and photomultipliers. The minimum concentration is of the order of 50 grains/m². Moreover, in-depth burial can only be determined by taking cores and by subsequently counting the one-to-two centimetre sediment layers, which further increases the number of samples to be analyzed.

In conclusion, fluorescent tracers have the advantage of being totally harmless, easily prepared and easy to inject, but

in order to obtain a good picture of sediment transport the amount of tracer to be injected is high (between 100 kg and 1000 kg). These tracers are available in many colours; during one and the same test, several of them may therefore be used for the tagging of different granulometric categories.

The major drawback is data analysis, which is lengthy and laborious because automated systems will not be reliable enough for use in the near future.

Moreover, repeating the test on the same site presents a major problem because the site remains polluted by the painted grains.

On the continental shelf, only an underwater test can provide sufficient accuracy to interpret the sediment transport in a meaningful way. Such an operation could become very costly and it is not certain to achieve the objectives. Bratteland and Brunn (1974) were only able to obtain descriptive results of an experiment conducted at the Ekofisk oil exploration site, in the North Sea, in spite of work covering 450 days by a series of divers who sampled on the basis of a precise, pre-established grid.

4.4 RADIOACTIVE TRACERS

Work using radioactive tracers to study sediment movement was first undertaken in 1954 (Putman et al., 1954; Hours et al., 1955). For 10 years, this approach remained in the hands of radioactivity experts who developed tagging techniques (Smith and Eukins, 1957; Zakeotki, 1958; Rispal, 1962; Cambell, 1963; Gilbert and Cordiero, 1962; Petersen, 1960, 1963; Becker and

Golte, 1965; Meyn, 1965; Jeanneau, 1965; Bougault, 1966, Bougault et al., 1967; Patrikeyer et Orlova, 1968; Stephens et al., 1968), and immersion and detection techniques (Dolezal et al., 1965; Callesen and Otterstrom, 1961). During that period, the interpretation of results was restricted to qualitative studies. Since 1962, quantitative approaches have been developed (Crickmore and Lean, 1962a and b; Crickmore, 1964; Courtois, 1964, 1966, 1968, 1970; Courtois and Sauzay, 1965, 1966, 1970 and Sauzay, 1968). Parallel to the development of these quantitative methods, applications of this technique became increasingly frequent both on the continental shelf and in estuaries and rivers. In 1979, the C.E.N. Saclay team conducted over 200 tracer immersions (Caillot, 1979).

Since 1955 the use of radioactive tracers in sedimentology has continued to improve. Initially, detection of radioactive materials was effected point by point, then Crickmore and Lean (1962, 1963), Hubbel and Sayre (1964), and Courtois (1964) developed the principles of dynamic detection, while Campbell (1963, 1964), Campbell and Seatonberry (1967) and Vukmirovic et al. (1964) developed the principles of static detection (Fig. 4.7). Automatic data acquisition systems were developed by Duane and Judge (1968) within the framework of the RIST program, in cooperation with the Oak Ridge National Laboratory (ORNL). That program developed its own detection system. After using Xe 133 with varying results (Duane and Judge, 1968), Au 198 (Duane, 1970), then Ru 103 (Lavelle et al., 1978) were used to trace sediment movements in outfall zones in estuaries or on the

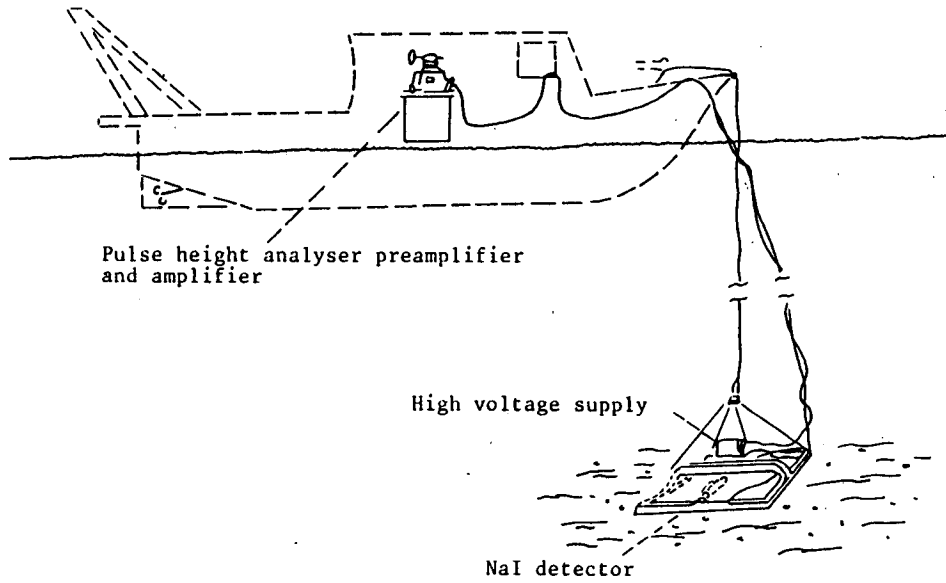

a) Détection statique (d'après Durham et Gable, 1977).

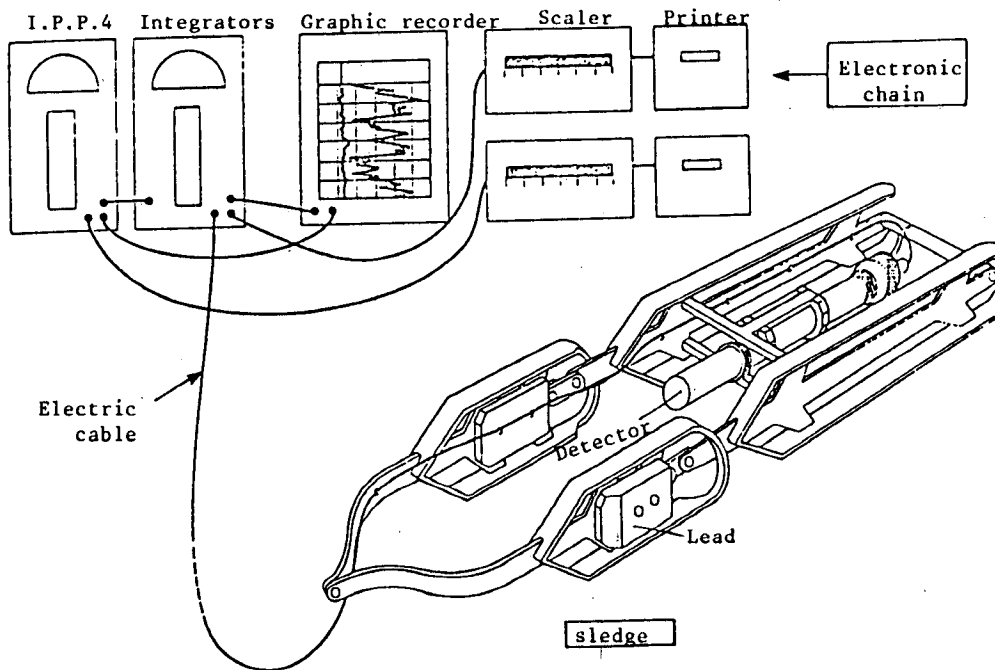

b) Détection dynamique (d'après Tola, 1982).

Fig. 4.7 Data acquisition systems.

continental shelf. Nelson and Coakley (1974) mentioned that the system, originally of a very heavy design (the detector weighed 500 lbs), became miniaturized and data interpretation is now very fast due to a fully automated system. Simultaneously with the system developed by ORNL, Courtois (1964) and Sauzay (1968) developed a more compact system that was gradually automated (Courtois, 1968; Caillot et al., 1974; Caillot, 1979 and Tola, 1982). Since 1975, this technique has been developed in Canada and it has been used in intertidal areas (Long, 1977; 1978), in estuary areas (Long, 1983) and in infralittoral areas (Long and Drapeau, 1983) (Fig. 4.8).

The isotopes used are all gamma emitters (Table VI). In the past, phosphorus 32 (hard beta emitter) was used in Portugal, but gamma emitters have been preferred recently because their detection is much more accurate. The tracers are used either as surface coatings of natural sediments or as glass that can be activated. They are available commercially from the ORNL or from the Centre d'Etude Nucleaire at Saclay, France.

Radio-elements are put to different uses depending on their half-life (or period). Gold (^{198}Au), arsenic (^{76}As) and xenon (^{132}Xe) are used to trace rapid sediment movements such as those occurring within an outfall area. Medium-period taggers ^{147}Nd , ^{51}Cr and ^{103}Ru are used for tests covering periods of 30 to 90 days, whereas ^{192}Ir and ^{46}Sc can be used for 180 to 360-day tests. The experiments can usually last four tracer half-lives. The degree of activity required is limited both by the maximum activity per grain and by the overall activity, in order to comply with the control standards of the Atomic Energy Control

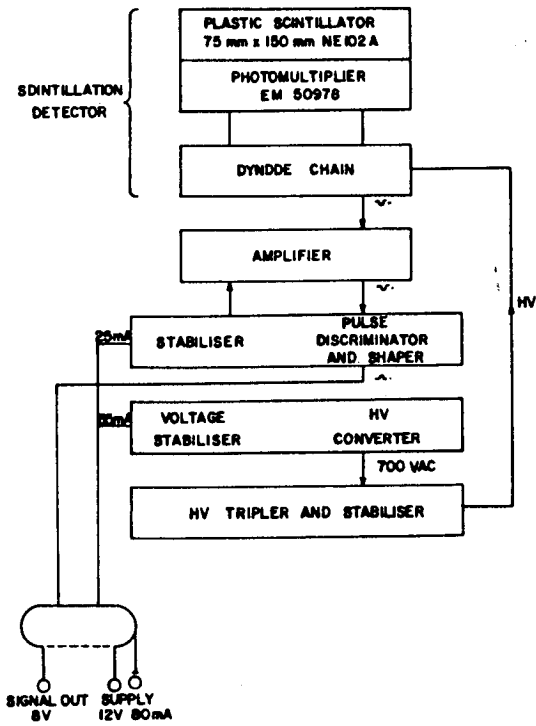

SONDE DE DETECTION (Tois, 1982)

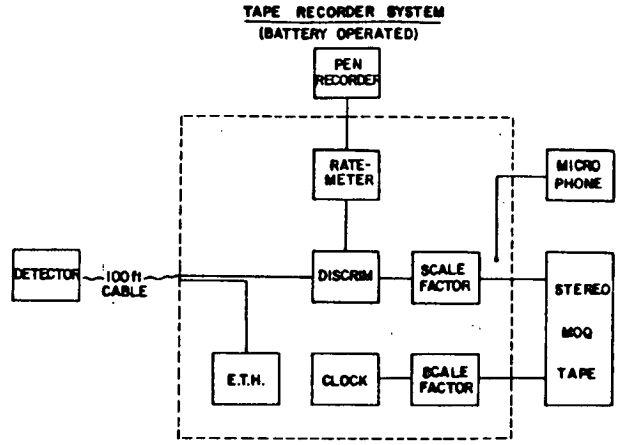

TAPE REPLAY SYSTEM

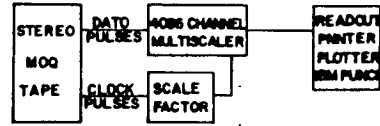

SYSTÈME FRANÇAIS (Tois, 1982)

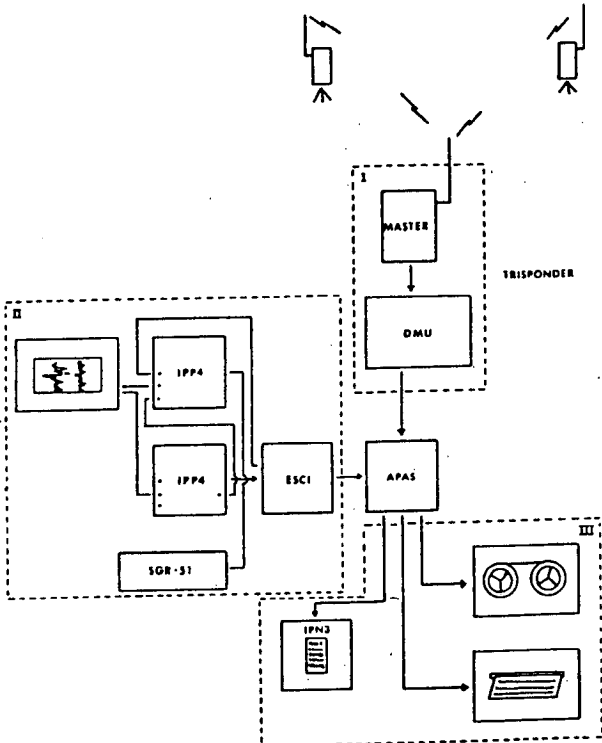

SYSTÈME CANADIEN (Long et Drapeau, 1983)

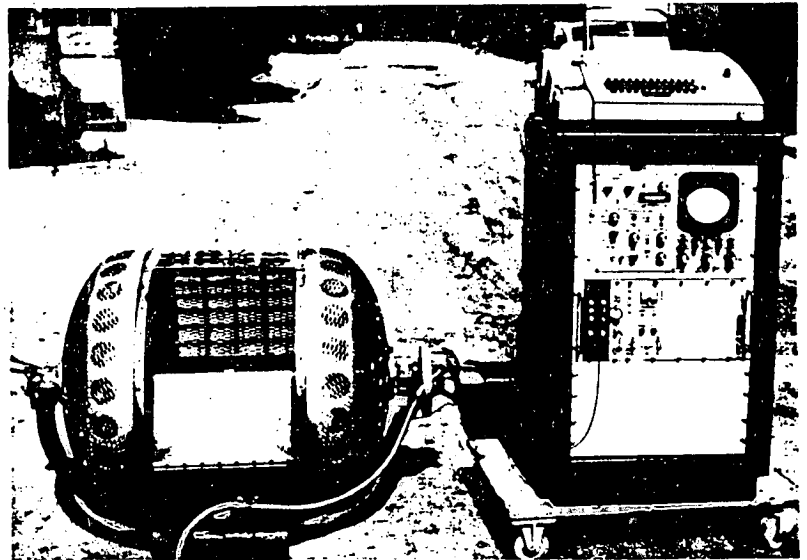

Fig. 4.8 Different data acquisition systems used around the world.

TABLE VI

Principal radio-isotopes used in sediment transport experiments.

Qualité du traceur: (F) faible, (B) bon, (E) excellent.

ISOTOPES	PÉRIODES	ÉNERGIE MOYENNE DE γ EN MeV	FORME D'UTILISATION MARQUAGE	VERRE	DOMAINE D'EMPLOI EN SÉDIMENTOLOGIE
^{113}In	0.07	0.3	bakélite vases	-	Modèles hydrauliques (B)
^{76}As	1.10	0.560	surface (sable)		Mouvement des sables (F)
^{198}Au	2.7	0.412	surface	x	Mouvement des sables et argiles (E)
^{133}Xe	5.2	0.081	xenonation	-	Mouvement des sables (F)
^{147}Nd	11.1	0.260	-	x	Mouvement des sables (B)
$^{140}\text{Ba} + ^{140}\text{La}$	12.8	1.596	surface	-	Mouvement des sables (B)
^{51}Cr	27.8	0.32	-	x	Mouvement des sables et argiles (E)
^{103}Ru	39.8		surface		Mouvement des sables (E)
$^{170} + ^{181}\text{Hf}$	40 - 70	0.10 - 0.50	surface	-	Mouvement des argiles (B)
^{59}Fe	45	1.20	surface	-	Mouvement des sables (F)
^{192}Ir	74.2	0.36		x	Mouvement des sables (E)
^{46}Sc	84	1.0	surface	x	Mouvement des sables et argiles (E)
^{182}Ta	111	1.0	inclusion	x	Mouvement des galets et sables (E)
^{65}Zn	245	1.10	surface	x	Mouvement des argiles (B)
^{110}Ag	253	0.66 - 0.94	surface	x	Mouvement des sables et galets (B)

Board of Canada. Long et al. (1978) determined the permissible and recommended limits for the main isotopes used in sedimentology (Fig. 4.9). This work follows up on the recommendations of Courtois and Hours (1965) and of Petersen (1965), who had established proposals regarding the specific conditions for the use of artificial radio-elements to study sediment movements, by calculating the risks inherent in radio-isotope use. These limitations do not detract in any way from the effectiveness of the method; Courtois and Sauzay (1970) determined the minimum mass and the minimum activity to be injected for tracing tests. It appears that the use of 1 kg of tracer is sufficient and that, for tracers with a mean energy of 360 KeV (such as ^{192}Ir) or 260 KeV (^{147}Nd), 2 curies ($1\mu\text{Ci} = 37 \times 10^3$ Cps) are sufficient for a tracer experiment in the infralittoral area or on the continental shelf. The levels of activity of 150 curies for ^{110}Ag (Anon, 1972) or 92 curies for ^{46}Sc (Heathershaw, 1981) do not seem justified because the activity per grain becomes so strong that detector saturation occurs in the high concentration areas, thus reducing the accuracy of the results.

Tracer immersion is effected either by means of soluble bags (Lavelle et al., 1978), or by means of an immersion system that opens as it hits the seabed. These systems are not too bulky, due to the small amount of material to be injected (Fig. 4.2).

Dynamic detection is most commonly used and the results are obtained within a very short time.

In conclusion, the study of sediment movement using

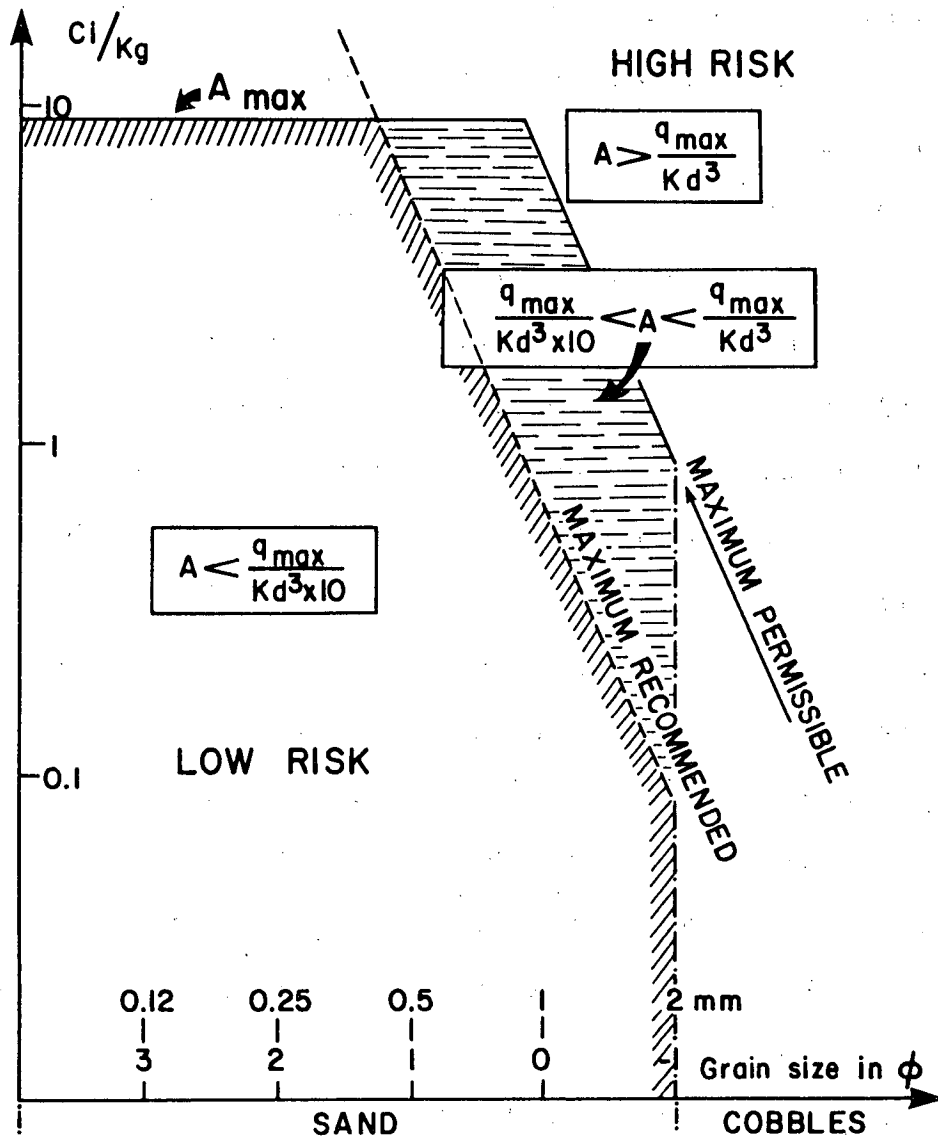

Fig. 4.9 Diagram showing the permissible and recommended activities for radioactive tracers used in mobile sediment studies.

radioactive tracers is probably the most powerful approach available in sediment tracing. Using very small amounts of tracer (between 500 g and 1000 g per injection), this technique does not disturb the environment and the "good mix" conditions occur very quickly, unlike what happens when large amounts (100 kg) are used, which is precisely the case with the other tracing methods.

Moreover, due to automation in the field, a permanent check of sediment movement is obtained in situ, thus optimizing data acquisition and making it possible to determine accurately the amount of sediment in motion.

4.5 OTHER TAGGING TECHNIQUES

Alongside tests using fluorescent radioactive tracers, some authors have attempted to use other artificial tracers to determine sediment transport. These various approaches have never led to the development of reliable methods for the quantitative determination of sediment transport.

a) MAGNETIC TRACERS

Several authors attempted to use magnetic tracers as derivatives of radioactive tracers. Pantin (1961) used them by incorporating magnetic material into concrete pebbles. Criesseir and Hoeg (1964) and Hartke (1967) suggested the use of magnetic sand to simulate sediment transport but this apparently attractive technique was never developed.

b) ANALYSIS THROUGH THERMOLUMINESCENCE

This analysis is based on the properties of crystalline materials that, subjected to ionization by gamma or RX radiation,

switch to an easily-detected meta-stable electronic state. Although this approach seems very attractive because the hydrodynamic properties of the material rendered thermoluminescent are not affected in any way, the problem of detecting the tracer remains, since no in situ detection apparatus is presently operational. Research on this method is under way at the Canadian Centre for Inland Waters (Nelson and Coakley, 1974).

c) ANALYSIS THROUGH NEUTRON ACTIVATION

This approach was developed to replace radioactive tracers whenever it was impossible to use them. The first studies were made under the leadership of Goldberg and Inman (1955), then Inman (1958) and Inman and Chamberlain (1959). More recently, Groot et al., (1970, 1973) have improved this tracing technique.

No quantitative studies are feasible by this method and its major drawback is the fact that only a very small amount of material can be properly irradiated. However, the mass of material to be irradiated by a very powerful neutron flux is very large; the methodology is therefore very cumbersome and the results take a long time to materialize. The high quality of measurements that can be obtained by means of neutron activation analysis is cancelled out by the small amount of irradiated material that can be counted in the tracer. In order to obtain a statistically valid count, the counting time must be extended, thereby making the analysis process even more cumbersome. No readjustment in sampling is then possible (Nelson and Coakley, 1974). It therefore does not seem advisable, given the present

state of the art, to use this approach on the continental shelf.

4.6 GENERAL CONCLUSION

This review of the literature shows that only two tracing methods are presently operational, namely fluorescent tracers and radioactive tracers. The former provide quantitative results only under very specific conditions. A survey of tracing tests conducted at depths in excess of 15 m (Table VII) shows that the use of radioactive tracers in small amounts (of the order of 1 kg) may permit monitoring of sediment transport for a period long enough to be representative.

The use of an autonomous measurement system could be attractive for the continental shelf because it would permit detection of very small sediment movements.

The use of fluorescent tracer at great depths does not seem advisable, as it involves the immersion of a large amount of tracer and therefore a very long period during which "good mix" conditions will not prevail.

The various techniques for tracing sandy sediments were compared by Duane and Judge (1969); the conclusions are tabulated in Annex 1.

TABLE VII

Different experiments described in the literature for water depths exceeding 15 m.

AUTEUR / ANNÉE	RÉGION	TYPE DE TRACEUR	PROFONDEUR	DURÉE	RÉSULTATS
Vernon (1966)	Catalina Isl. Caf. U.S.A.	luminescent détection en plongée	-30m	plusieurs mois	descriptif
Got (1970)	Baie de Banyuls France	détection dynamique Cr-51 (500g/13Ci)	-30m/-20m	60 j	descriptif (faible transport)
Longuemard (1974)	Atlantique France	Ta-192 (90g/150mCi) grille fixe automatique	-28m	une semaine	descriptif
Bratteland et Bruun (1974)	Ekofish Mer du Nord	luminescent (100 kg) détection en plognée	-70m	450 j	descriptif
Caillot <i>et al.</i> (1975)	Atlantique France	détection dynamique Ir-192 (900g/1.5Ci)	-22.5/-15m	90 j	quantitatif
Caillot <i>et al.</i> (1978)	Méditerranée France	détection dynamique Ir-192	-17.5m	210 j	quantitatif
Heathershaw (1981)	Swansea Bay U.K.	détection dynamique Sc-46 (653g/92Ci)	~ -17m	155 j	quantitatif
Quesney <i>et al.</i> (1982)	Baie de Seine France	détection dynamique Ir-192 (720g/1Ci)	-17.5m	208 j	quantitatif
Lees (1983)	East Anglia Coast U.K.	luminescent (750 kg)	-17m	231 j	quantitatif
Lavelle <i>et al.</i> (1978)	New York Bight U.S.A.	détection dynamique Ru-103 (590g/10Ci)	-21m -21.5m	64 j 76 j	quantitatif quantitatif

ANNEX I: Comparison of sand tracing methods (after Duane and Judge, 1969).

Fluorescent-Tagged Sand	Radioisotope-Tagged Sand	Stable-Tagged Sand Activation Analysis	Natural Minerals
<p>Low to moderate cost; requires no special handling. EPS license.</p> <p>Sampling difficult; grab samples and limited numbers possible; sample validity in field; difficult to obtain.</p> <p>Analysis required on individual samples; interference from natural background minerals.</p> <p>Sampling slow, not possible to obtain good representation of dynamic system.</p> <p>Related data difficult to correlate with samples.</p> <p>Results of test lag field sampling.</p>	<p>Moderate to high cost; special handling and licensing (AECB and EPS)</p> <p>Sampling easy; special equipment required; unlimited data potential; immediate indication of sample validity.</p> <p>Analysis and sampling in situ.</p> <p>Sampling fast; dynamic sampling in dynamic system.</p> <p>Samples easily correlated with other data.</p> <p>Results of test rapid; initial evaluation ~ 24 hr.</p>	<p>Moderate to high cost; requires no special handling. EPS license.</p> <p>Sampling difficult; grab samples, limited numbers; no sample validity in field.</p> <p>Analysis required; interference from natural background minerals.</p> <p>Sampling slow, not possible to obtain good representation of dynamic system.</p> <p>Related data difficult to correlate with samples.</p> <p>Results of test lag field test.</p>	<p>Low cost; requires no special handling.</p> <p>Sampling difficult; grab samples, limited numbers; characteristics of mineral may exhibit sorting and concentration not easily related to transport phenomena.</p> <p>Analysis required on individual samples.</p> <p>Sampling slow, not possible to obtain good representation of dynamic system.</p> <p>Related data difficult to correlate with samples.</p> <p>Results of test lag field test.</p>

ANNEX 1: Continued

Fluorescent-Tagged Sand	Radioisotope-Tagged Sand	Stable-Tagged Sand Activation Analysis	Natural Minerals
Core sampling required for burial information	In situ sampling possible for burial determination or indicated by mathematical models.	Core sampling required for burial information.	Core sampling required for burial information.
Large quantities of tracer required 100 - 1000 kg.	Small quantities of tracer required 500 - 1000 g.	Large quantities of tracer required 100 - 1000 kg.	Source of mineral must be established and alternate sources must be absent.
Total data collection necessary to obtain direction, speed, and quantity of sediment; transport believed to be highly uncertain due to limited sample potential and statistical requirements.	Total data collection necessary to obtain direction, speed, and quantity of sediment; transport possible as indicated by mathematical models and wave tank experiments.	Total data collection necessary to obtain direction, speed, and quantity of sediment; transport believed to be highly uncertain due to limited sample potential and statistical requirements.	Data limited to determination of direction and distance of transport.
Public relations problems unlikely.	Public relations problems exist (problem can be minimized with proper control).	Public relations problems unlikely.	Public relations problems unlikely.
Survey area may be contaimined for future tests	Rapid clearing of survey area with short half-life isotopes.	Survey area may be contaminated for future tests.	Not possible to assign time to transport information or retest area.
Technique established and well developed.	Technique established and well developed; excellent potential for high utility.	Technique demonstrated; sensitivity problems.	Technique established and well developed.

4.7 REFERENCES

- Alquier, M., G. Courtois, J. Gruat et G. Sauzay, 1970. La notion de "bon mélange" dans l'emploi de traceurs. Vitesse débitante et vitesse du centre de gravité d'un nuage de traceurs dans l'étude d'un écoulement. La Houille Blanche, 7.70 : 643-650.
- Alquier, M., J. Gruat et G. Courtois, 1970. Utilisation de la formule d'Einstein. Comparaison avec la formule de Meyer-Peter dans le domaine du début d'entraînement. La Houille Blanche, 7.70 : 658-660.
- Anon, 1972. Out of sight, out of mind. Report of working party on sludge disposal in Liverpool Bay. HMSO. SBN 11-7504 56-4, vol. 2, Dept. of Envir., England, 483 p.
- Bastin, A., 1963. L'emploi de mesures de bruit de fond pour l'établissement d'une carte lithologique du fond de la mer. Compte rendu Réunion de Travail, Bureau Eurisotop, Euratom.
- Bastin, A., 1973. Natural radioactive tracers. In: Technical report series no 145-IAEA, Vienna.
- Becker, H. and H. Gotte, 1965. Procédé de marquage d'échantillons de sable naturel au moyen de substances radioactives. C.r. réunion Bruxelles, 2-5 Oct. 1963. Eurisotop, Cah. Inf. 8, communication 12 : 179-184.
- Bougault, H., 1966. Le marquage des sédiments pélagiques par l'or 198 et le chrome 51. Rapport de stage DR/S.R.S/66-37/BH/JJ.
- Bougault, H., A. Caillot, G. Courtois and B. Jeanneau, 1967. Dépôts superficiels de radioéléments sur les sables et les vases. In: Isotopes in Hydrology, Vienna, IAEA, p. 233-262.
- Bratteland, E. and P. Bruun, 1974. Tracer tests in the middle North Sea. Proceedings 14th Coastal Eng. Conf., Copenhagen, ASCE publ., 2 : 978-990.
- Bridge, J.S., 1981. Hydraulic interpretation of grain-size distribution using a physical model for bedload transport. J. Sediment. Petrol., 51 (4) : 1109-1124.
- Brown, P.J., R. Ehrlich and D.J. Colquhoun, 1980. Origin of patterns of quartz sand types on the southeastern United States continental shelf sedimentation - Fourier grain shape. Analysis J. Sediment. Petrol., 50 (4) : 1095-1100.
- Byerly, J.R., 1963. Naturally occurring radioactive mineral as littoral tracers. Shore and Beach, (April 1983).

- Caillot, A., 1970. Les méthodes de marquage des sédiments par des indicateurs radioactifs. *La Houille Blanche*, 7 : 661-674.
- Caillot, A., G. Courtois, P. Gourlez and G. Sausay, 1974. Les techniques nucléaires en sédimentologie dynamique. Rapport interne DCA/SAPRA/75-05/GS, 32 p.
- Caillot, A., P. Gourlez, J. Massias et G. Sauzay, 1977. Contribution à l'emploi des traceurs fluorescents en sédimentologie dynamique. Rapport CEN Saclay, SARR/77/15/C 248/PS, 23 p.
- Caillot, A., 1975. Action de la houle sur les sédiments. Synthèse des expériences faites en nature à l'aide de traceurs radioactifs. CEA Internal Report C-258, 105 p.
- Caillot, A., M. Quesney and G. Wilson, 1978. Contribution to the study of the movement of sediments along the Belgium littoral with radioactive tracers. CEA Internal Report, SAPRA/78/13.
- Caillot, A., 1979. L'utilisation des traceurs en sédimentologie dynamique. Rapport interne. DCA/SARR/SAPRA/70/09/C 259/AC, 45 p.
- Callesen, O. and K. Otterstrom, 1961. Methods of determining sand movement by means of radioactive labeled sand. In: International Congress of Navigation, 20th, Baltimore. Ocean Navigation, Sect. II, Brussels, Secrétariat Général, A.I.P.C.N., p. 41-49.
- Campbell, B.L., 1963. An improved technique for labelling sand with ^{198}Au . *Int. J. Appl. Radiat. Isotopes*, 14 (5) : 286-287.
- Campbell, B.L., 1964. Sediment research in Australia. *Atomic Energy Australia*, 7 : 13-17.
- Campbell, B.L. and B.W. Seatonberry, 1967. Surface labelling of sand with ^{51}Cr by thermal decomposition of ammonium dichromate ^{51}Cr . In: *Isotopes in Hydrology*, Vienna, IAEA, p. 227-232.
- Case, F.N., E.H. Acree and H.R. Brashear, 1971a. A survey system for use in tracing radionuclide-tagged sediment in the marine environment. In: *Nuclear Techniques in Environmental Pollution*, Vienna, IAEA, p. 603-628.
- Case, F.N., E.H. Acree and H.R. Brashear, 1971b. Detection system for tracing radionuclide labeled sediment in the marine environment. *Isotopes and Radiation Technology*, 8 : 412-414.
- Case, F.N., 1975. The application of radionuclide in the study of sediment transport and treatment of waste effluents. *Am. Nucl. Soc.*, 22 : 109-110.
- Chambers, R.L. and S.B. Upchurch, 1974. Distinction of dynamic provenances of sediments by R-mode factor analysis. In: North-Central Section, 8th Annual Meeting. *Geol. Soc. Am. Abstr.*, 6 (6) : 499.

- Clark, R.A. and R.H. Osborne, 1982. Contribution of salinas river sand to the beaches of Monterey Bay, California, during the 1978 flood period : Fourier grain-shape analysis. *J. Sediment. Petrol.*, 52 (3) : 0807-0822.
- Courtois, G., 1964. Possibilités d'emploi d'un nombre limité de grains radioactifs dans les études quantitatives de mouvements de sédiments. *Int. J. Appl. Radiat. Isotopes*, 15 : 655-663.
- Courtois, G. and R. Hours, 1965. Propositions concernant les conditions particulières d'emploi des radioéléments artificiels pour étudier les mouvements de sédiments. *Bur. Eurisotop., Cah. d'Inform.*, 8 (29) : 441-480.
- Courtois, G. and G. Sauzay, 1965. Possibilités de détermination quantitative des débits de sédiments par l'emploi de traceurs radioactifs : Utilisation de sondes à réponse linéaire. *Proc. 11th Int. Assoc. Hyd. Res. Conf., Leningrad*, p. 192-197.
- Courtois, G., 1966. Emploi de radioéléments en sédimentologie. Colloque sur l'emploi des radioéléments en hydrologie, SM 83/9, Vienna.
- Courtois, G. and A. Monaco, 1966. Méthode des traceurs radioactifs appliquée à l'étude des transits sédimentaires le long du littoral roussillonnais. *Cah. Oceanog.*, 18 : 139-149.
- Courtois, G. and G. Sauzay, 1966. Count rate balance methods using radioactive tracer for measuring sediment mass flows. *La Houille Blanche*, 21 : 279-290.
- Courtois, G., 1968. The use of radioisotopes in sand movement and bedload material studies. In: *Guide Book on Nuclear Techniques in Hydrology*, IAEA, Vienna, p. 79-91.
- Courtois, G. and A. Monaco, 1968. Étude comparative de deux méthodes radioactives d'évaluation massique des transports sédimentaires littoraux. *Cahiers Océanographiques*, 20 : 775-783.
- Courtois, G. and A. Monaco, 1969. Radioactive methods for the quantitative determination of coastal drift rate. *Marine Geology*, 7 : 183-206.
- Courtois, G., 1970. La dynamique sédimentaire et les traceurs radioactifs (Point de la situation en France). *La Houille Blanche*, 7 : 617-628.
- Courtois, G. and G. Sauzay, 1970. Les masses de sédiment marqués à injecter dans une expérience de traceurs radioactifs en sédimentologie dynamique. *La Houille Blanche*, 7 : 629-642.
- Crickmore, M.J., 1964. A note on tracer methods for the field measurement of sand transport. *Internal Report INT 38, Hydraulics Research Station, DSIR, Wallingford, Berks, England*, 5 p.
- Crickmore, M.J. and G.H. Lean, 1962a. The measurement of sand transport by means of radioactive tracers. *Proceedings of Royal Society of London, Série A*, vol. 266.

- Crickmore, M.J. and G.H. Lean, 1962b. The measurement of sand transport by the time integration method with radioactive tracers. Proceedings of Royal Society of London, Série A, 270 : 27-47.
- Crickmore, M.J. and G.H. Lean, 1963. Methods for measuring sand transport using radioactive tracers. Radio-Isotopes in Hydrology, Symposium, Tokyo, AIEA, Vienna.
- Crickmore, M.J., 1967. Measurement of sand transport in rivers with special reference to tracer methods. Sedimentology, 8 : 175-228.
- De Vries, M., 1966. Applications of luminophores in sand transport studies. Delft Tech. Univ. Lab. Mining Rep., Pub. 39.
- De Vries, M., 1967. Photometric counter for fluorescent tracers. La Houille Blanche, 22 (7) : 717-722.
- De Vries, M., 1971. On the applicability of fluorescent tracers in sedimentology. Delft Hydraulics Laboratory, publication no 94, 17 p.
- Dolezal, R., M. Petersen, H. Becker, H. Goette, G. Schulze-Pillot, E. Tomschke, B. Boettcher, K.H. Nachtigall and E. Siebold, 1965. Development and testing of radioactive tracer method for measuring the kinetics of erosion and sand displacement caused by surf. EUR-2167.d, European Atomic Energy Community.
- Drapeau, G. and B. Long, 1984. Measurements of bedload transport in the nearshore zone using radioisotopic sand tracers. Abstract, 19th Coastal Eng. Conf., ASCE, Houston, Texas.
- Duane, D.B. and C.W. Judge, 1969. Radio-isotopic sand tracer study, Point Conception, California. Preliminary Report on accomplishments. July 1966 - June 1968. U.S. Army Coastal Engineering Research Center, Miscellaneous paper 2-69, 81 p.
- Duane, D.B., 1970a. Tracing sand movement in the littoral zone : progress in the radio-isotope sand tracer (RIST) study. U.S. Army Corps of Engineers Coastal Engineering Center, MP4-70, 52 p.
- Duane, D.B., 1970b. Synoptic observations of sand movement. Proc. 12th Coastal Eng. Conf., Washington, D.C., ASCE publ., p. 799-813.
- Duane, D.B. and W.R. James, 1980. Littoral transport in the surf zone elucidated by an Eulerian sediment tracer experiment. J. Sed. Petrology, 50 (3) : 929-942.
- Durham, R.W. et R.J. Gable, 1977. A radiotracer technique for measuring sediment movement. Rapport CCIW no 80, 16 p.
- Ehrlich, R., J.J. Orzeck and B. Weinberg, 1974. Detrital quartz as a natural tracer-Fourier grain shape analysis. J. Sed. Petrol., 44 : 145-150.

- Ehrlich, R., P.J. Brown, J.M. Yarus and R.S. Przygocki, 1980. The origin of shape frequency distributions and the relationship between size and shape. *J. Sediment. Petrol.*, 50 (2) : 475-484.
- Friedman, G.M., 1961. Distinction between dune, beach and river sands from textural characteristics. *Jour. Sed. Petrology*, 31 : 514-529.
- Friedman, G.M., 1967. Dynamic processes and statistical parameters compared for size frequency distribution of beach and river sands. *Jour. Sed. Petrology*, 37 : 327-354.
- Gable, G.C., Ed., 1981. Report on data from the Nearshore Sediment Transport Study Experiment at Torrey Pines Beach, California, January-February 1980. University of California, San Diego, Institute of Marine Resources, IMR Ref. no 80-5, S.I.O/UCSD 314 p.
- Gaucher, J.C., H. Got, J. Labeyrie, E. Lalou and A. Lansiaert, 1974. Application de la spectrométrie γ *in situ* à la cartographie granulométrique sous-marine. *Bull. B.R.G.M.* 2 (IV), 4-1974, 231-241.
- Gilbert, A. and S. Cordeiro, 1962. A general method for sand labelling with radioactive nuclides. *Int. J. Appl. Radiat. Isotopes*, 13 : 41-46.
- Goldberg, E.D. and D.L. Inman, 1955. Neutron-irradiated quartz as a tracer of sand movements. *Bulletin of Geological Society of America*, 66 : 611-613.
- Got, M., 1970. Résultat des expériences de traceurs radioactifs réalisées dans la baie de Banyuls. Rapport CEA, SAR S/70/07, 10 p.
- Got, H., 1971. Répartition du thorium, radium, potassium dans les sédiments du plateau continental Catalan. *C.R. Sc. Ac. Sci.*, Paris, Fr., 272.
- Got, H., 1974. Les variations de la radioactivité naturelle des sédiments superficiels du plateau continental pyreneo-catalan (Espagne). *Rapp. Comm. int. Mer Médit.*, 22 (8) : 37.
- Grant Gross, M., 1966. Distribution of radioactive marine sediment derived from the Columbia River. *Journal Geoph. Research*, 71 (8).
- Grant Gross, M. and J.L. Nelson, 1966. Sediment movement on the continental shelf near Washington and Oregon. *Science*, 154 (3750).
- Greenwood, B., P.B. Hale and P.R. Mittler, 1979. Sediment flux determination in the nearshore zone : prototype measurements. *In: Workshop on Instrumentation for Currents and Sediments in the Nearshore Zone*, NRC, Ottawa, p. 99-119.
- Griesseier, H. and S. Hoeg, 1964. Durch Ferromagnetika markierte Sedimente und Möglichkeiten ihrer automatischen Zählung. *Acta hydrophys.*, 9 : 35-53.

- Groot, A.J. de, E. Allersma, M. de Bruin and J.P.W. Houtman, 1970. Cobalt and tantalum tracers measured by activation analysis in sediment transport studies. In: Isotope Hydrology, IAEA, Vienna, p. 885-898.
- Groot, A.J. de *et al.*, 1973. Use of activable tracers. In: Technical report series no 145, IAEA, Vienna.
- Hartke, H., 1967. Quantitative determination of sediment accumulation under the effect of hydrodynamic conditions using magnetic tracers. *Mber. dt. Akad. Wiss. Berl.* 9 : 578 (in German).
- Heathershaw, A.D., 1981. Comparaisons of measured and predicted sediment transport rates in tidal currents. *Marine Geology*, 42 : 75-104.
- Hours, R., W.D. Nesteroff et V. Romanovsky, 1955. Méthode d'étude de l'évolution des plages par traceurs radioactifs. *Raport C.R.E.O.* I (11), 1965.
- Horn, R., F. Le Lann and M. Tireront, 1973. Recherche d'ilménite au large des côtes du Sénégal. *BRGM*, 74 SGN 256 MAR.
- Hubbel, D.W. and W.W. Sayre, 1964. Sand transport studies with radioactive tracers. *Proceedings of the American Society of Civil Engineers*, 90 (HY3).
- Hudson, C.B. and R. Ehrlich, 1980. Determination of relative provenance contributions in samples of quartz sand using Q-mode factor analysis of Fourier grain shape data. *J. Sediment. Petrol.*, 50 (4) : 1101-1110.
- Huston, K.H., 1963. A critical appraisal of the technique of using naturally occurring radioactive minerals as littoral tracers. Institute of Engineering Research, Hydraulic Engineering Laboratory Wave Research projects, HEL-4-1, University of California, California.
- Ingle, J.C. Jr., 1962. Tracing beach sand movement by means of fluorescent dyed sand. *Shore Beach*, 30 : 31-36.
- Ingle, J.C. and D.S. Gorsline, 1973. Use of fluorescent tracers in the near-shore environment. In: *Tracer Techniques in Sediment Transport*. Technical Report Series no 145, pp. 125-148, IAEA, Vienna.
- Inman, D.L., 1958. Experiments with artificially radioactive sand as tracers of shelf sediment movement. *Proc. 2nd Int. Conf. Peaceful Uses of Atomic Energy* 15/P/1981.
- Inman, D.L. and T.K. Chamberlain, 1959. Tracing beach sand movement with irradiated quartz. *J. Geoph. Res.*, 64 (1) : 41-47.
- Inman, D.L., J.A. Zampol, T.E. While, D.M. Hanes, B.W. Waldurf and V.A. Kostens, 1980. Field Measurements of Sand Motion in the Surf Zone. *17th Int. Conf. on Coastal Eng.*, 1215-1234.

- Jeanneau, B., 1965. Étude des dépôts d'argent sur les sédiments siliceux en vue de les marquer par ^{198}Au , expériences faites sur un sable de rivière. Internal Report DR-AR/65, Section d'Application des Radio-éléments de Saclay, Centre d'Études Nucléaires.
- Jolliffe, I.P., 1963. A study of sand movements on the Lowestoft sand bank using fluorescent tracers. *Geographical Journal*, vol. 129.
- Judge, C.W., 1970. Heavy minerals in beach and stream sediments as indicators of shore processes between Monterey and Los Angeles, California. U.S. Army Coastal Engineering Research Center, Technical memorandum 33.
- Kidson, C. and A.P. Carr, 1962. Marking beach materials for tracing experiments. *American Soc. Civil Engrs., Jour. Hydraulics Div. Paper 3189*, 18 p.
- Klovan, J.E., 1966. The use of factor analysis in determining depositional environments from grain size distributions. *Jour. Sed. Petrology*, 36 : 115-125.
- Lavelle, J.W., D.J.P. Swift, P.E. Gadd, W.L. Stubblefield, T.N. Case, H.R. Brashear and K.W. Haff, 1978. Fair weather and storm sand transport on the Long Island, New York, inner shelf *Sedimentology. Jour. Sed. Petrology*, 25 : 823-842.
- Lean, G.H. and M.J. Crickmore, 1963. Methods for measuring sand transport using radioactive tracers. In: *Radioisotope in Hydrology*. Vienna, International Atomic Energy Agency, p. 111-131.
- Lees, B.J., 1979. A new technique for injecting fluorescent sand tracer in sediment transport experiments in a shallow water marine environment. *Mar. Geol.*, 33 (3-4) : M95-M98.
- Lees, B.J., 1983. The relationship of sediment transport rates and paths to sand banks in a tidally dominated area off the coast of East Anglia. *U.K. Sedimentology*, 30 : 461-483.
- Lees, B.J., 1983. Sizewell Dunwich Banks field study topic report 7. Final report - a study of nearshore sediment transport processes. *Inst. Oceanogr. Sci. Report no 146*, 46 p.
- Long, B., 1977. Determination of sediment transport rate in the Minas Basin, Nova Scotia. Preliminary results of the first tracer experiment using radio-isotopes. *Geol. Sur. Can., Paper 77-1B*, p. 85-92.
- Long, B.F. et J.P. Barousseau, 1978. A method for the analysis of the sediment evolution. An exemple during the last 3000 years in the Bay of Biscaye. France 10th International Congress on Sedimentology, Jerusalem 78. Abstract book.
- Long, B., N. Kulkarni and G. Joice, 1978. Radioisotopes as sediment tracers: risks involved and proposed guidelines for use. B.I.O. report series, B.I.O., 78-3, 38 p.

- Long, B.F. et G. Drapeau, 1983. Évolution du transport sédimentaire par traceur radio-actif sur la zone infralittorale de la Basse Côte Nord. Canadian Coastal Conference '83, Vancouver, B.J. Holden, ed., p. 201-215.
- Longuemard, J.P., 1974. Sur une nouvelle méthode d'étude des transits sédimentaires sur les plateaux continentaux. Mem. Inst. Geol. Bassin Aquitaine, no 7 : 369-376.
- Markovich, J.V., R. Ehrlich and B. Weinberg, 1976. New techniques for stratigraphic analysis and correlation - Fourier grain shape analysis Louisiana offshore Pliocene. Jour. Sed. Petrology 46 : 226-233.
- McLaren, Patrick, 1981. An interpretation of trends in grain size measures. Jour. Sed. Petrology, 51 (2) : 0611-0624.
- McLaren, W.A., and W.R. Buckingham, 1983. Sand movement study in Fraser River foreshore. Proceedings Canadian Coastal Conference, May 11-14, 1983, B.J. Holden (ed.), p. 217-233.
- McMaster, R.L., 1966. Mineralogy as an indicator of beach sand movement along the Rhode Island shore. Jour. Sed. Petrology, 30 (3) : 404-413.
- Meyn, G., 1965. Technique de marquage radioactif pour l'étude des mouvements de sable dans les eaux côtières allemandes. C.r. réunion Bruxelles, 2-5 oct. 1963. Eurisotop, Cah. Inf. 8, communication 14, p. 195-200.
- Miller, J.M. and G.D. Symons, 1973. Radiometric traverse of the seabed off the Yorkshire coast. Nature, 6.B : 242.
- Minami, K., 1965. Measurement of sand-drift on the seabed by a water-tight G-M detector. Radioisotopes (Tokyo) 14 : 83-88.
- Nelson, D.E. and J.P. Coakley, 1974. Techniques for tracing sediment movements. Scientific Ser., no 32, Inland Waters Directorate, Canada Centre for Inland Waters, Burlington, Ontario, 40 p.
- Olsen, C.R., P.E. Biscaye, H.J. Simpson, R.M. Trier, K. Kostyk, R.F. Bopp, Y.H. Li and H.W. Feely, 1980. Reactor-released radio-nucleides and fine grained sediment transport and accumulation patterns in Barnegat Bay, New Jersey and adjacent shelf waters. Estuarine Coastal Mar. Sci., 10 : 119-142.
- Pantin, H.M., 1961. Magnetic concrete as an artificial tracer material. New Zealand, J. Geol. Geophys., 4 : 424-433.
- Patrikeyev, V.V. and G.A. Orlova, 1968. A new method of marking and quantitatively estimating tracer sands and silt in bottom samples. Trans. by American Geophysical Union, Oceanology, 8 (2) : 276-280.

- Petersen, B.R., 1960. Some radioactive surface labeling methods. *Ingeniøren*, 4 : 99-102.
- Petersen, M., 1965. Risques inhérents à l'utilisation des radioisotopes et mesures de protection requises. C.r. réunion Bruxelles, 2-5 oct. 1963, *Eurisotop*, Cah. Inf. 8, communication 27, p. 411-416.
- Pilon, J.J., 1965. Mesures par traceurs radioactifs du mouvement des sables aux Pays-Bas, 1957-1962. C.r. réunion, Bruxelles 3-5 oct. 1963, *Eurisotop*, Cah. Inf. 8, communication 15, p. 201-314.
- Porter, G.A., R. Ehrlich, R.H. Osborne and R.A. Combellick, 1979. Sources and nonsources of beach sand along southern Monterey Bay, California - Fourier shape analysis. *Jour. Sed. Petrology*, 49 (3) : 727-732.
- Putman, J.L., B.D. Smith, F. Allen et G. Rowan, 1954. Thames siltation investigation, preliminary experiments of the use of radioactive tracers for indicating mud movement. Rapport AERE/I/R/1576.
- Quesney, M., R. Hoslin and J. Massias, 1982. Étude au moyen de traceurs radioactifs des mouvements sédimentaires en Baie-de-Seine. Rapport OR15/SAR/S-82-22/04, 75 p.
- Rice, R.M., D.S. Gorsline and R.H. Osborne, 1976. Relationships between sand input from rivers and the composition of sand from the beaches of Southern California. *Sedimentology*, 23 : 689-703.
- Rispaï, C., 1962. (Patent to Commissariat à l'Énergie Atomique), Radioactive labeling of sandy sediments. Fr. 1,338,882, Oct. 4, 1963; Appl. June 25, 1962; 12 p.
- Rivière, A., 1965. Intérêt sédimentologique de la mesure des radioactivités naturelles. *C.R. Acad. Sciences*, 241 : 964-966.
- Rivière, A. et S. Vernhet, 1966. Études littorales. Contribution à l'étude des rivages du golfe de Lion. Signification sédimentologiques des radioactivités naturelles. *Cahiers océanographiques* no 10 : 857-900.
- Ross, D.A., 1978. Atlantic continental shelf and slope of the U.S.; heavy minerals of the continental margin from southern Nova Scotia to northern New Jersey. *U.S. Geol. Surv., Prof. pap.*, no 529-G, 43 p.
- Russell, R.C.H., D.E. Newman and K.W. Tomlinson, 1963. Sediment discharges measured by continuous injection from a point. *Proc. 10th Congr. Int. Assoc. Hyd. Res.*, London, 1 : 69-76.
- Sauzay, G., 1968. Méthode du bilan du taux de comptage d'indicateurs radioactifs pour la détermination du débit de charriage des lits sableux. Rapport CEA-R no 3431, 162 p.

- Sauzay, G. and G. Courtois, 1970. Radioactive tracers applied to measurements of suspended load and bedload discharge. Proc. Koblenz Symp. on Hydrometry, Unesco/UMO/IAHS, 2 : 627-635.
- Sayles, F.L., 1966. A reconnaissance heavy mineral study of Monterey Bay beach sediment. Hydraulic Engineering Laboratory, University of California, Berkeley, HEL-2-16.
- Schulz, H. and G. Pillot, 1965. Détermination quantitative des mouvements de sable. C.r. réunion Bruxelles, 2-5 oct. 1963. Eurisotop, Cah. Inf. 8, communication 25 : 401-406.
- Smith, D.B. and J.D. Eukins, 1957. Radioactive methods for labeling and tracing sand and pebbles in investigations of littoral drift. Unesco/NS/RIC/63 Pergamon Press, London.
- Stephens, N.H., E.H. Acrie and F.N. Case, 1968. Evaluation of four methods using Gold 198 for surface labeling sand and a new technique for simulating mass labeling. Oak Ridge National Laboratory Report ORNL-4338, p. 9.
- Stuiver, M. and J.A. Purpura, 1968. Application of fluorescent coastal sand in littoral drift and inlet studies. Proc. 11th Coastal Eng. Conf., London, ASCE publ., p. 307-321.
- Tashjian, Z., J. Cherry, G. Gordon and M. Gablinger, 1964. Radiometric determination of thorium in coastal sands for tracing littoral sediment. Hydraulics Engineering Lab., Report HEL 5-3, University of California, Berkeley.
- Teleki, P.G., 1967. Automatic analysis of tracer sand. Journal of Sedimentary Petrology, 37 : 749-759.
- Tola, F., 1982. The use of radioactive tracers in dynamic sedimentology. Rapport CEA-N-2261, 42 p.
- Trask, P.D., 1952. Source of beach sand at Santa Barbara, California, as indicated by mineral grain studies. U.S. Army Corps of Engineers, Beach Erosion Board, Technical Memorandum no 28.
- Vernon, J.W., 1966. Shelf sediment transport system. Ph.D. dissertation in Geological Sciences, University of Southern California.
- Visher, G.S., 1969. Grain size distributions and depositional processes. Jour. Sed. Petrology, 39 : 1074-1106.
- Vukmirovic, V., A. Filip, P. Todorovic and R. Vukotic, 1964. Radioactive tracers in studying bed load movement. Trans. Inst. Jaroslav Cerni, 31. 9 (31) : 31-38.
- Yasso, W.E., 1962. Fluorescent coatings on coarse sediments; an integrated system. Off. Naval Res. Geog. Br., Tech. Rpt. #1, Proj. NR 388-057, Contr. Nonr. 266 (68), 48 p.